



HER KİLOMETREDE YENİ / NEWER IN EVERY MILE

EURO I, II, III EGZOZLARI

EURO I, II, III EXHAUST SYSTEMS

ÜRÜN KATALOĞU

PRODUCT CATALOGUE

Tecrübemizden gelen üstün mühendislik ve işçilik kalitesiyle geliştirdiğimiz, yeni nesil egzoz sistemlerimiz artık daha uzun ömürlü.

Our new generation exhaust systems, which we have developed with our superior engineering and workmanship from our experience, now have a longer life.



www.soylu.com

HER KİLOMETREDE YENİ / NEWER IN EVERY MILE

Daha iyisini yapmak için çıktığımız bu yolda,
Müşterilerimizin işine değer katacak parçaları üretiyoruz.
Sert koşullarda sağlam kalabilmeyi gerektiren işimiz,
Malzeme üzerinde en iyi sonucu almayı gerektiriyor.
Aracınızın ne istediğini bilen deneyimli mühendislerimizin,
Kaliteden ödün vermeyen çalışanlarımızın,
Kendini işine adanmış yönetim kadromuzun,
Tek amacı bunu gerçekleştirebilmek:
Köklerimizden gelen kalite ve yeniliği her kilometrede sunabilmektir.
Yerel üretimimiz, geniş servis ağıımız ve kolay tedarik hizmetlerimiz ile;
Ülkemizde üreten bir değer olma gayesiyle yükseliyoruz.

On this road we went out to do better,
We produce parts that will add value to our customers.
Our job is to be able to remain firm in harsh conditions,
It requires the best finish on the material.
Our experienced engineers, who know what your car wants,
Our employees who do not compromise in quality,
We have a dedicated management team,
The only goal is to be able to do this:
Quality and innovation from our roots can be offered every kilometer.
With our local production, extensive service network and easy
procurement services;
We rise up to be a value producing in our country.

www.soylu.com



EURO I, II, III EGZOZLARI

ÜRÜN KATALOĞU

PRODUCT CATALOGUE

EURO I, II, III EGZOZLARI

İÇİNDEKİLER / CONTENTS

Soylu'ya Bakış / About The Soylu

6

DAF

10

Iveco

78

MAN

139

Mercedes

199

Renault

247

Scania

297

Volvo

333

SOYLU'YA BAKIŞ / ABOUT THE SOYLU

Soylu Ltd. 2001 yılında İstanbul Dolapdere Sanayi Sitesinde Yönetim Kurulu Başkanımız Sn. Niyazi Soylu tarafından kurulmuştur. 2018 yılında Merkezi İstanbul'da olmak üzere; üretimi Düzce Gümüşova ilçesinde 9.000 metrekare kapalı 3000 metrekare açık alanlı fabrikasına taşınmaktadır. Her nevi motorlu araçların egzoz sistemleri üreticisi olarak faaliyet göstermeye başlayan Soylu Ltd. takip eden yıllarda, hava tankları ve yakıt depoları için pazarda güçlü bir talebin var olduğu neticesiyle ürün gamına eklemiştir.

Soylu Ltd. ürünleri için gerekli tüm bileşenleri kendi bünyesinde üretmekte olup, tüm üretim süreçleri ve satış sonrası hizmetlerde kalite yönetim sistemi doğrultusunda hareket ederek, güncel teknolojileri yakından takip etmektedir. Kullanılan tüm kalıplar, aparatlar Soylu Ltd. bünyesinde tasarlanmakta (thinkdesign) ve CAD/CAM programları ile (Mastercam, Machining Strategist) CNC tezgâhları kullanılarak, ISO 9001-2008 Kalite Yönetim Sistemi ile sertifikalandırıp Dünya standartlarında üretim gerçekleştirmektedir.

OEM ve After Market piyasasında ihtiyaçlara yönelik her türlü teknolojik altyapıya sahip olan Soylu Ltd. tesisleri'nde, sektörün ihtiyaçlarına yönelik çözüm üretmeye devam ediyor.

Daha iyisini yapmak için çıktığımız bu yolda müşterilerimizin işine değer katacak parçaları üretiyoruz. Yerel üretimimiz, geniş servis ağıımız ve kolay tedarik hizmetlerimiz ile; ülkemizde üreten bir değer olma gayesiyle yükseliyoruz.

Soylu Ltd. siz değerli müşterilerine hizmet vermenin haklı gururunu yaşamaktadır.

Soylu Ltd. was established in 2001 by Mr. Niyazi Soylu, the Chairman of the Board of Directors, at Dolapdere Industry area in Istanbul. The Head office was originally located in Istanbul, however, in 2018, production was moved to Düzce, to a new 3000m2 open area and 9000 m2 closed area factory. Soylu Ltd. started operation as a producer of exhaust systems for a diverse variety of motor vehicles. In the following years, due to a strong market demand for air and fuel tanks, these were also added to the range of products that Soylu Ltd. offers.

Soylu Ltd. produces all the necessary components for its products in accordance with a rigorous quality management system that is utilized throughout all production processes. All molds and apparatuses used by Soylu Ltd. are designed via (ThinkDesign) and CAD /CAM programs (Mastercam, Machining Strategist) and built using CNC machines, achieving ISO 9001-2008 Quality Management System certification. Soylu Ltd., which has the technological infrastructure for all needs in OEM and After Market facilities, continues to produce solutions for the needs of the industry.

In order to do better, we produce parts that will add value to our customers. With our local production, extensive service network and easy procurement services; we rise up to be a value producing in our country.

Soylu Ltd. is rightfully proud of serving our esteemed customers.

VİZYON / VISION

Otomotiv sektöründe, farklılıklar yaratarak ve sürekli büyüyerek, liderlik konumunu sürdüren bir marka olmak.

To secure the leading position within the automotive industry through innovative differences and continual growth.

STRATEJİ / STRATEGY

VERİMLİLİK:

- Sektörün en verimli şirketi haline gelme,
- Operasyonel verimlilik kapsamında ürün kalitesinin artırılması ve üretim maliyetlerinin düşürülmesini sağlama,
- Satış maliyetlerini azaltarak dağıtım kanallarında ve satış noktalarında daha verimli ve etkin olmasını sağlama.

MARKA YATIRIMLARI:

- Marka yatırımlarımızı sürekli kılma,
- Yeni ve kuvvetli ürünlerin tüketicilere sunulması,
- Talebi yaratacak, tüketimi arttıracak inovasyonları başarma.

STRATEJİMİZ KAPSAMINDA:

- Bölgesel güç olacak şekilde genişleme,
- Geniş Coğrafyada yeni pazarlara ulaşma,
- Sinerji çalışmalarını hem sahada hem üretimde uygulama,
- En iyi seviyede kurumsal yönetim uygulamalarını sürdürme,

Büyüyen Türkiye otomotiv sektöründe, Şirketimizin sürdürülebilir ve istikrarlı büyüme stratejisine dayanarak, çalışanlarımızla ve Şirket

IN THE AREA OF PRODUCTIVITY, WE AIM TO:

- Become the most productive company in the industry,
- Boost product quality through operational efficiency efforts and slash production costs,
- Achieve further efficiency and productivity in distribution channels and sales points by cutting sales costs.

IN BRAND INVESTMENTS, WE AIM TO:

- Ensure the continuity of our brand investments,
- Launch of new and strong products,
- Achieve success in innovation and lead higher demand consumption,

WITHIN THE CONTEXT OF STRATEGY, WE AIM TO:

- Expand to become a strong regional player,
 - Serving new consumers in wide geography,
 - Synergy studies both in the field and in production,
 - Implement and maintain good corporate governance practices at the highest level,
- Based on our Company's sustainable and stable growth

dışındaki müşterilerimizle sinerji içerisinde, inovasyon ve teknolojiyi kullanarak geliştireceğimiz yeni uygulamaları sektörde ilk hayata geçiren kurum olmayı hedefliyoruz. Bununla birlikte, ana ve yardımcı faaliyet kollarımızla ve hizmetlerimizle kaliteyi sürekli artırmak ve tüm paydaşlarımızı mutlu eden sonuçlara ulaşma hedefleriyle çalışıyoruz.

strategy in the growing Turkish automotive industry and in synergy with our employees and customers, we aim at being the first institution that implements newly developed applications using innovation and technology. Accordingly, we see it as our priority to work on new projects to continuously increase the quality and to we are working to reach to be happy our all stakeholders.

KALİTE / QUALITY

1. AMAÇ: Soylu Ltd. merkezi ve üretim destek süreçlerinin ve grubun koordinasyonunu yapar.

2. POLİTİKA: Mükemmel is modeli geliştirilmesi ve devam ettirilmesi amacıyla kalite yönetim sistemi tüm fonksiyonlarda aşağıdaki hedeflerin gerçekleşmesi için is süreçlerine katkıda bulunur.

2.1. ÇALIŞANLAR: Tüm çalışanlarda is performanslarının parça ve proses kalitesine etkisi, aktif olarak kalite ile ilgili süreçlerde rol almaları ve iletişimi verimli hale getirmeleri bilinci geliştirilir.

2.2. MÜŞTERİLER: Müşteri ihtiyaçlarının karşılanması ve müşteri memnuniyetinin artırılması.

2.3. TEDARİKÇİLER: Tedarikçilerimizin Kalite, Sevkiyat ve Servis performansları sürekli iyileştirme kapsamında değerlendirilir ve geliştirilir.

2.4. PROSESLER: Firma hedefleri ve Müşteri memnuniyeti doğrultusunda proseslerin verimliliği sürekli geliştirilerek

1. PURPOSE: Soylu Exhaust Systems ensure coordination for central and production support processes and group.

2. POLICY: Quality Management System contributes to business processes to achieve the following goals for all functions with the purpose of developing and maintaining an excellent business model.

2.1. EMPLOYEES: The consciousness is raised for all employees in order that they have an effect on part and process quality thanks to their work performances, they play an active part in relevant processes related to quality and they make the communication productive and efficient.

2.2. CUSTOMERS: Meeting the requirements of Customer and increasing the customer satisfaction.

2.3. SUPPLIERS: Quality, Shipment and Service performances of our Suppliers are evaluated and developed



"Sıfır Hatalı Parça Üretimi" ve "Tek Seferde Hatasız Üretim" hedefine ulaşmaya çalışılır.

2.5. KALİTE YÖNETİM SİSTEMİ VE STANDARTLARI: ISO 9001-2008 kalite yönetim sistemi, ISO 14001-2004 çevre yönetim sistemi ve CE belgesi ve müşteri özel isteklerine tam uyumluluk.

Çalışanlar, müşteriler ve son kullanıcılar nezdinde ürün emniyeti vaz geçilemeyecek bir gerekliliktir. Uygunluk, verimlilik ve etkinlik parametrelerinin ışığı altında kalite yönetim sistemi üst yönetim tarafından periyodik olarak gözden geçirilir ve gerekli görüldüğü takdirde uygun düzeltmeler ve eklemler yapılmaları için aksiyonlar başlatılır.



within the scope of continuous improvement.

2.4. PROCESSES: All efforts are made for achieving the goal stated as "Zero-Error Spare Part Production" and "Error-Free Production at once" by developing continuous productivity of processes according to firm's goals and Customer satisfaction.

2.5. QUALITY MANAGEMENT SYSTEMS AND STANDARDS: Full-compatible with ISO 9001-2008 Quality Management System, ISO 14001-2004, Environmental Management System, CE Certificate and Special Requirements of Customer.

Product security refers to a critical necessity for Employees, Customers and End-Users. Quality Management System is subject to periodical surveillance carried out by Senior Management in the light of Compatibility, Productivity and Efficiency parameters and actions are taken to make appropriate amendments and additions if appropriate.

İŞ GÜVENLİĞİ, SAĞLIK VE EMNİYET POLİTİKASI / WORK SAFETY, HEALTH AND SECURITY POLICY

Soylu Ltd. müşterilerine ve topluma hizmet verirken kalite, çevre, güvenlik, sağlık şartlarına uygun olarak çalışmayı ve buna bağlı yasal mevzuata riayet etmeyi şirket prensibi olarak kabul etmiştir.

Birinci önceliğimiz hataları meydana gelmeden önlemektir; bunu kurmuş olduğumuz etkin sürekli iyileştirme, önleme ve düzeltme sistemi ile gerçekleştiririz.

When providing services for its customers and society, Soylu Ltd. accepts to work in compliance with quality, environment, security and health conditions and requirements and follow the legal regulation with respect to this as a company principle.

Our first priority is to prevent the occurrence of any mistake; we make this happen through an established, efficient and

Hizmetlerimizi yerine getirirken, müşterilerimizin bize emanet ettikleri ürün, ekipman ve bilginin yüksek değerinin bilincinde hareket ederek, bunların güvenliği ve bütünlüğünü korumak için gerekli tüm önlemleri almayı taahhüt ederiz.

Benzer şekilde, hizmetimizin kalite ve güvenliğini sürdürmek için şirket varlığımızı da suistimalden ve zarardan korumayı öncelikli görevlerimiz arasında kabul ediyoruz.

Bu prensipler çerçevesinde sorumlu olduğumuz tarafların kalite, çevre, güvenlik ve sağlık

continuous improvement, avoidance and correction system.

When providing our services, we hereby guarantee to take all necessary precautions in order to protect safety and entirety of all products, equipments and information consigned to us by our customers by acting with the consciousness of high value of such information.

Accordingly, we hereby accept to protect our corporate assets from any misuse and damage as an essential duty with the purpose of maintaining

ile ilgili beklentilerini karşılamak; bunu yaparken de bizden kaynaklanan çevre etkilerini en düşük seviyeye indirmek ve kaynaklarımızı etkin kullanarak gelecek nesillere daha iyi bir ekolojik çevre bırakmak amaç ve hedeflerimiz arasındadır.

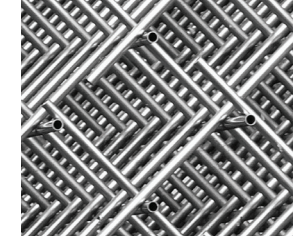

the quality and safety of our services.

Within the frame of such principles; issues such as meeting the expectations related to environment, safety and health of parties for whom we are responsible; minimalising the environmental effects arising from our intervention when carrying out this and providing more ecological environment for future generations by using our resources effectively are available amount our goals and purposes.



AR-GE / R&D

Ar-Ge Merkezi'nde yapılan geliştirme faaliyetleri ile OEM ve After Market müşterilerinin talep ettiği ürün süreci yönetilmektedir. Sürdürülebilir büyüme modeli stratejisi ile sürekli ileri teknolojiye yatırım yapan Soylu Ltd. Ar-Ge Merkezi; tasarım, test ve analiz imkanları ile inovatif ürünler ortaya çıkarmaktadır. Proje bazında ürün tasarım kabiliyeti ile ön plana çıkan Soylu Ltd. Ar-Ge Merkezi, fikri ve sınai

The priority of Soylu Exhaust Systems is the high quality and eco-friendly production which is better than the other competitors. Soylu, that volume-produces in the light of this information, is a company that produces sheet metal parts, air intake pipes, chassis pipes, radiator pipes and water pipes beside the exhaust equipment and has already proved its quality to the whole world with the qualified labour force. And

mülkiyet hakları Soylu Ltd.'e ait olan ve Ar-Ge kapsamında geliştirilen patentli ürünler ve endüstriyel tasarımlar ortaya çıkarmaktadır.

Yenilikçi ve sürdürülebilir bir anlayışa sahip olan Soylu Ltd. genç ve dinamik AR-GE ekibi, ileri Teknolojiye yönelik araştırma ve tasarımları ile farkımızı ortaya koymaktadır.

provides the production with strict quality control standards at the every stage of production.

The prototypes of the products are prepared as agreeably to the strict quality control and standards by R&D department.

Soylu Exhaust Systems that has a muffler production capacity ranging between Ø89 mm - Ø905 mm and 55 different types of scale; reduces the need for resources with the silencer body clamps it develops and maximizes the product performance.

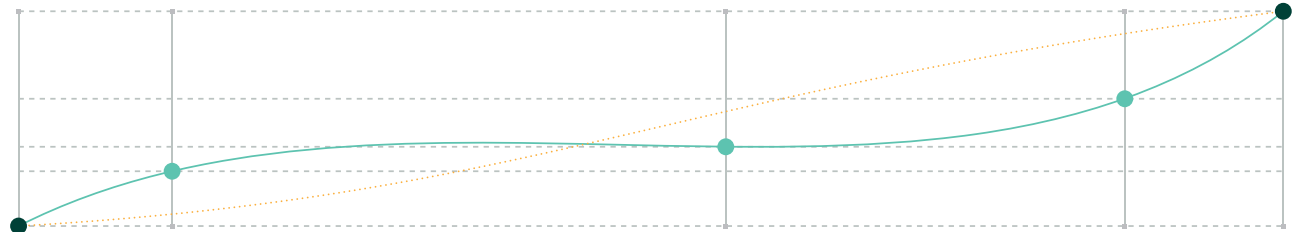

**GARANTİ UYGULAMALARI /
GUARANTEE APPLICATIONS**

Müşteri memnuniyeti ve toplam kalite yönetimini temel ilke olarak benimseyen Soylu Ltd. satış sonrası hizmet kalitesini de bu temel ilkeler doğrultusunda geliştirmektedir.

Soylu Ltd. ürünlerinde garanti süresi; malın müşteriye satış tarihinden itibaren başlar ve 2 yıl sürer.

Customer satisfaction and total quality management as a basic principle, adopting the quality of after sales service Soylu Ltd. that are developing in line with the basic principles.

Soylu Ltd. products warranty period; from the date of sale to the customer of the goods begins and lasts for 2 years.

Malın bütün parçaları dahil olmak üzere tamamı firmamızın garantisini kapsamaktadır. Garanti talebinin kabul edilebilmesi için, parçanın arıza yaptığı tarihin garanti döneminin içerisinde olması esastır.

Ürününüzle birlikte almanız gereken garanti belgenizin, ürünün garanti kapsamında değiştirilebilmesi veya arızanın giderilebilmesi için mutlak ibrazı gereklidir.

All goods are covered by our guarantee all parts including.

Warranty claim is to be considered, it is essential to have in his history of the warranty period of breakdown.

If you need warranty document that came with the product, the product can be exchanged under warranty or failure about the absolute submission is required.



SERTİFİKALAR / CERTIFICATES



TS EN ISO 14001 - 2004 Çevre Yönetim Sistemi



ISO 9001- 2008 Kalite Yönetim Sistemi



CE Belgesi - EEC 70/157 Standartları



SOYLU / EURO I, II, III

DAF

45	11	75 CF	39
55	12	85 CF	43
LF 45	13	CF 75	47
LF 55	23	CF 75/CF 85	51
65 / 75	30	CF 85	54
75 / 85	31	95	59
65 CF	36	95 XF	60
CF 65	37	XF 95	65

Series 45

Type

Euro II
06.96 →

45.130
45.150
45.160

Front pipeT Ta Silencer ail pipe

67657
APUA584
ACHD930



67613
APUA780

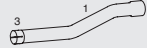

67596
ACHH812

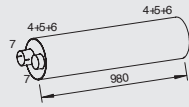

67591
ACHH362

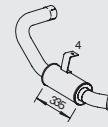

67989
ACHD099



Mounting Parts

1.
08890
682602
677939
677938



2.
11482
1250953
ACU3933
1401689



3.
00499
APUA555
1403646



4.
11488
0487257



5.
67426
ACHH763



6.
67421
ACHD074
0487257



7.
00406
ACHD812



Horizontal
LHD
Standard

Series 55

Type

Euro II
1996 →

 55.180
55.210

Front pipe

Silencer

Tail pipe

67661
ACHH007
5010223505

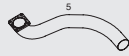

67670
ACHH361

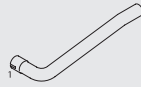

67596
ACHH812

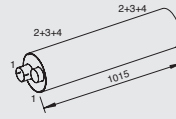

67591
ACHH362

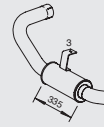

67657
APUA584
ACHD930



67613
APUA780

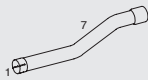

67989
ACHD099



Mounting Parts

1.
00406
ACHD812



2.
67426
ACHH763



3.
11488
0487257



4.
67421
ACHD074
0487257



5.
28063



6.
11482
1250953
ACU3933
1401689



7.
08890
682602
677939
677938



Horizontal
LHD
Standard

Series LF 45

Type

Euro III
01/2001 →



7,5t on.
10 ton.
12 ton.

FA 45.130
FA 45.150
FA 45.170

BE 99 C
3,9l tr.
4 cyl.
99 KW/135 HP

BE 110C
3,9l tr.
4 cyl.
110K W/150H P

BE 123C
3,9l tr.
4 cyl.
123K W/167H P

Front pipe

Silencer

Tail pipe

66773
1406196
1700847

66612
1406197

66619
1406260

67549
1401653
APUB213
APUD030

67961
1401587
1401586

67625
1405122

67621
1401712

67600
1401711

67938
1401854
1406807
LHD

Mounting Parts

1.
44437
1400876

2.
11482
1250953
ACU3933
1401689

3.
00499
APUA555
1403646

4.
67491
1401634

4. Alternative.
67481
1406719
1702273

5.
67082
1405498
1401125
1405193

6.
00499
APUA555
1403646

7.
67083
1405631

8.
66481
1406851

Horizontal
LHD/RHD
Standard

Series LF 45

Type

Euro III
01/2001 →



7,5t on.
10 ton.
12 ton.

FA 45.150
FA 45.170

BE 110C
3,9l tr.
4 cyl.
110K W/150H P

BE 123C
3,9l tr.
4 cyl.
123K W/167H P

Horizontal
LHD/RHD
Standard

Front pipe

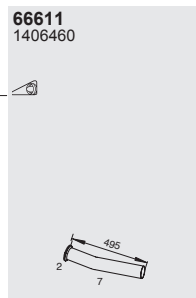
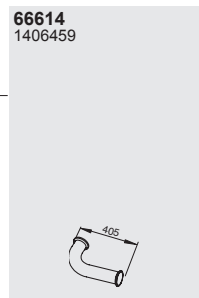
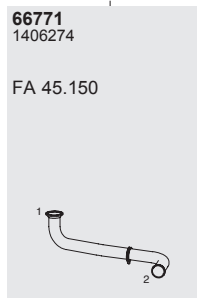
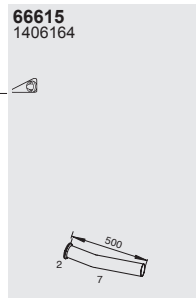
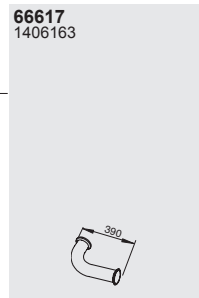
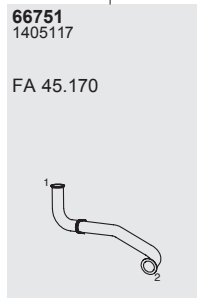
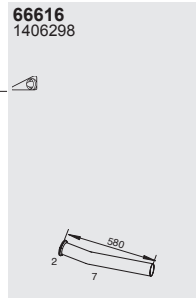
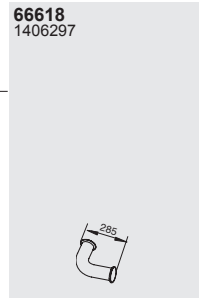
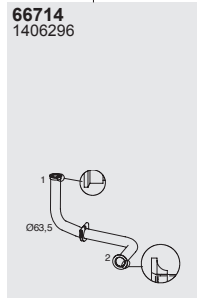

Silencer

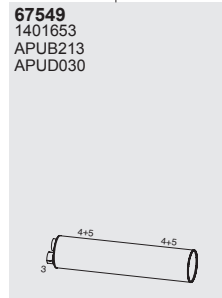

Tail pipe



Mounting Parts

1.
44437
1400876

2.
11482
1250953
ACU3933
1401689

3.
00499
APUA555
1403646

4.
67491
1401634

5.
67082
1405498
1401125
1405193

6.
00408
1400882
1404738
1513012

7.
08890
682602
677939
677938

Series LF 45

Type

Euro III
01/2001 →



7,5t on.
10 ton.
12 ton.

FA 45.180
FA 45.220

CE 136 C
5,9l tr.
6 cyl.
136K W/185H P

CE 162 C
5,9l tr.
6 cyl.
162K W/220H P

Front pipeS

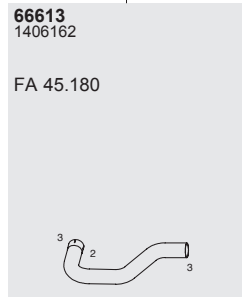
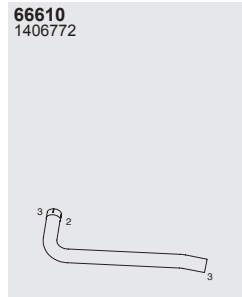
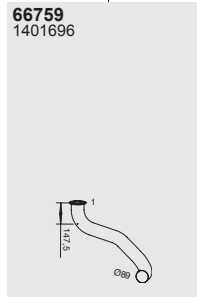

ilencer

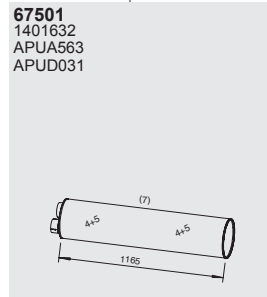

Tail pipe

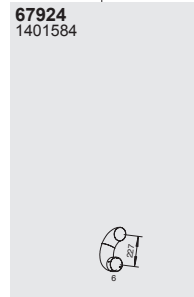

Mounting Parts

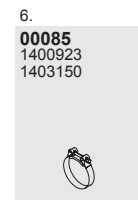
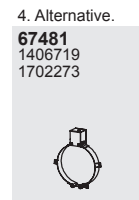
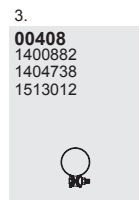
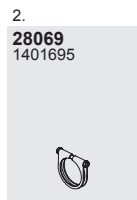

Horizontal
LHD/RHD
Standard

Series LF 45

Type

Euro III
01/2001 →



7,5t on.
10 ton.
12 ton.

FA 45.180
FA 45.220

CE 136 C
5,9l tr.
6 cyl.
136K W/185H P

CE 162 C
5,9l tr.
6 cyl.
162K W/220H P

Horizontal
LHD/RHD
Standard

Front pipe

22137
1401696

FA 45.220

22246
1406162

21251
1401703

22145
1405114

22176
1406160

22133
1401702

Silencer

21394
1401632
APUA563
APUD031

Tail pipe

21757
1401587

Mounting Parts

1.
70804
1401693

2.
50927
1401695

3.
99890
1400882
1404738
1513012

4.
21874
1401634

4. Alternative.
21804
1406719
1702273

5.
21905
1405498
1401125
1405193

6.
99903
1400923
1403150

7.
22804
1406851

Series LF 45

Type

Euro III
01/2001 →



7,5t on.
10 ton.
12 ton.

FA 55.130
FA 45.150
FA 45.170

BE 99 C
3,9l tr.
4 cyl.
99 KW/135 HP

BE 110C
3,9l tr.
4 cyl.
110K W/150H P

BE 123C
3,9l tr.
4 cyl.
123K W/167H P

Vertical
LHD/RHD
Standard

Front pipe

67625
1405122

FA 45.150,170

67621
1401712

66773
1406196
1700847

66612
1406197

FA 45.130,150,170

66619
1406260

FA 45.130

Silencer

67549
1401653
APUB213
APUD030

67932
1403219

66638
1408067

FA 45.150,170
Usew ith front pipe 22116

Tail pipe

67833
1403220

Mounting Parts

1.
44437
1400876

2.
11482
1250953
ACU3933
1401689

3.
00499
APUA555
1403646

4.
67491
1401634

5.
67082
1405498
1401125
1405193

6.
00408
1400882
1404738
1513012

7.
67083
1405631

8.
08890
682602
677939
677938

Series LF 45

Type

Euro III
01/2001 →



7,5t on.
10 ton.
12 ton.

FA 55.130
FA 45.150
FA 45.170

BE 99 C
3,9l tr.
4 cyl.
99 KW/135 HP

BE 110C
3,9l tr.
4 cyl.
110K W/150H P

BE 123C
3,9l tr.
4 cyl.
123K W/167H P

Front pipe

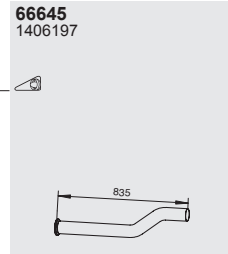
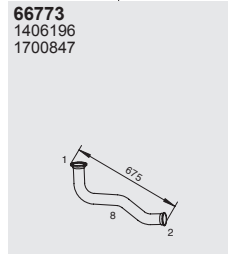

Silencer

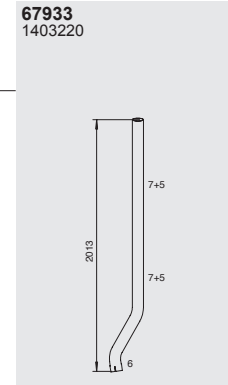
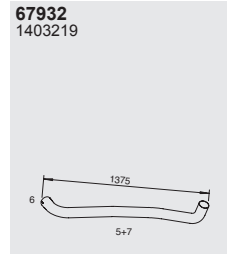
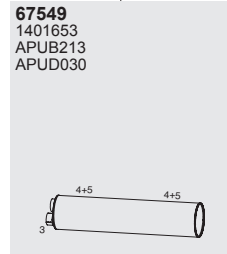

Tail pipe

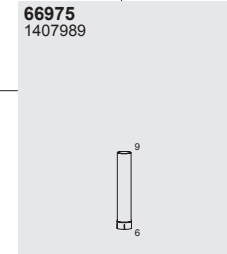

Mounting Parts

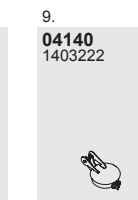
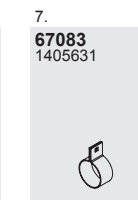
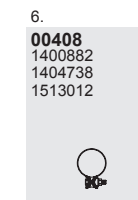
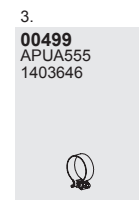
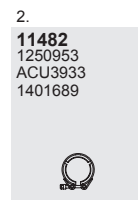
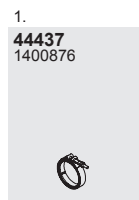

Vertical
LHD/RHD
Standard

Series LF 45

Type

Euro III
01/2001 →



7,5t on.
10 ton.
12 ton.

FA 45.150
FA 45.170

BE 110C
3,9l tr.
4 cyl.
110K W/150H P

BE 123C
3,9l tr.
4 cyl.
123K W/167H P

Front pipe

Silencer

Tail pipe

66773
1406196
1700847
FA 45.150,170

66612
1406197

67549
1401653
APUB213
APUD030

66974
1406836

Mounting Parts

1.
44437
1400876

2.
11482
1250953
ACU3933
1401689

3.
00499
APUA555
1403646

4.
67491
1401634

5.
67082
1405498
1401125
1405193

6.
00480
1400882
1404738
1513012

7.
67083
1405631

8.
08890
682602
677939
677938

Horizontal
LHD
Standard

Series LF 45

Type

Euro III
01/2001 →



7,5t on.
10 ton.
12 ton.

FA 45.180
FA 45.220

CE 136 C
5,9l tr.
6 cyl.
136K W/185H P

CE 162 C
5,9l tr.
6 cyl.
162K W/220H P

Horizontal
LHD
Standard

Front pipe

Silencer

Tail pipe

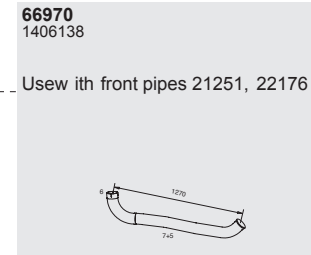
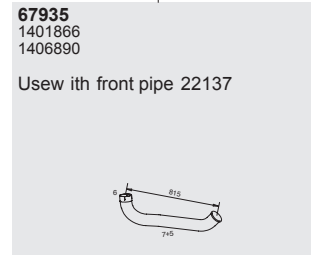
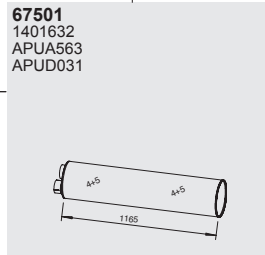
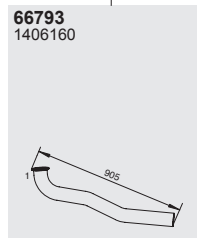
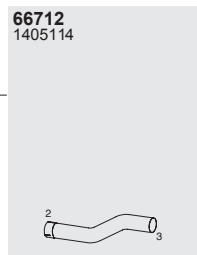
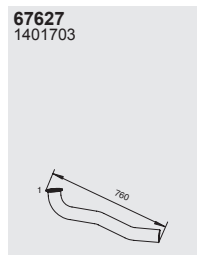
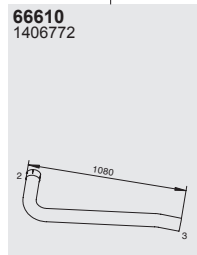
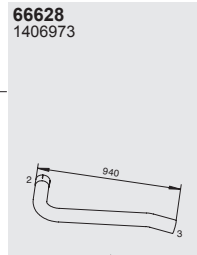
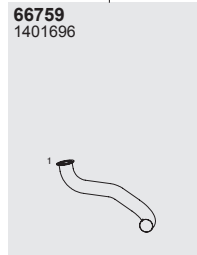

Mounting Parts

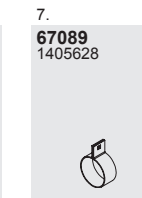
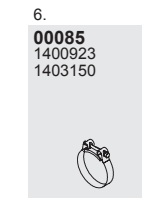
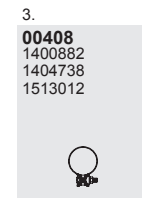
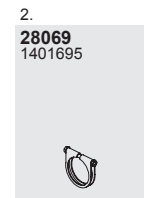
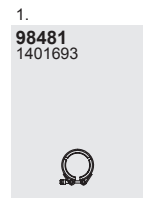

Series LF 45

Type

Euro III
01/2001 →



7,5t on.
10 ton.
12 ton.

FA 45.180
FA 45.220

CE 136 C
5,9l tr.
6 cyl.
136K W/185H P

CE 162 C
5,9l tr.
6 cyl.
162K W/220H P

Front pipe

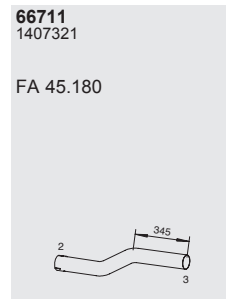
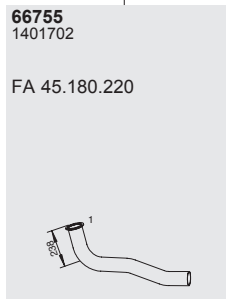
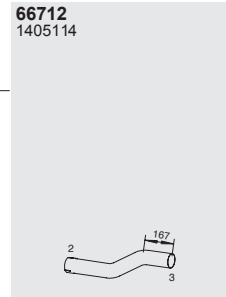

Silencer

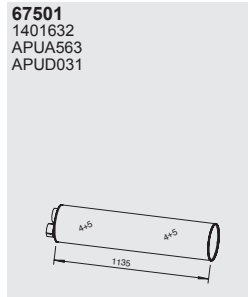

Tail pipe

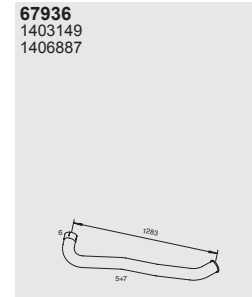

Mounting Parts

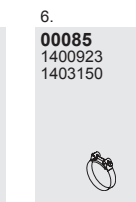
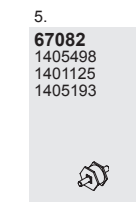
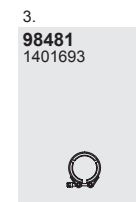
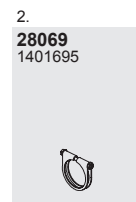

Horizontal
LHD
Standard

Series LF 45

Type

Euro III
01/2001 →



7,5t on.
12 ton.

FA 45.220

CE 162 C
5,9l tr.
6 cyl.
162K W/220H P

Front pipe

Silencer

Tail pipe

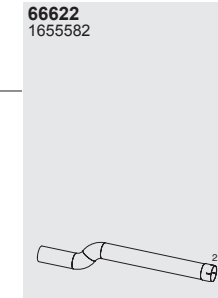
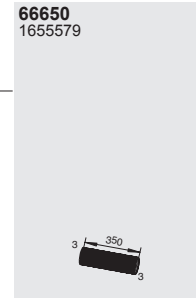
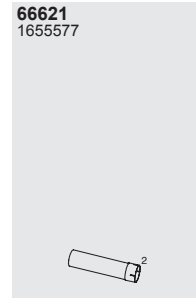
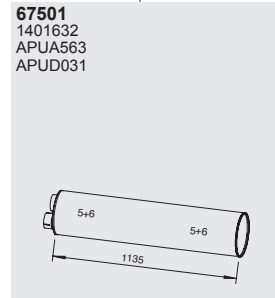
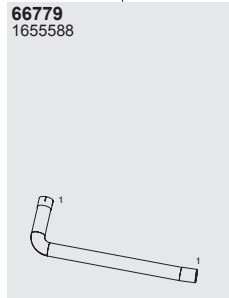

Mounting Parts

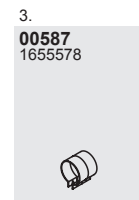
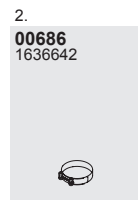
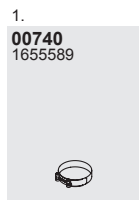

Horizontal
LHD
Standard

Series LF 55

Type

Euro III
01/2001 →

FA 55.180
FT 55.220
FT 55.250



13 ton.
15 ton.
18 ton.

CE 136 C
5,9l tr.
6 cyl.
136K W/185H P

CE 162 C
5,9l tr.
6 cyl.
162K W/220H P

CE 184C
5,9l tr.
6 cyl.
184K W/250H P

Horizontal
LHD/RHD
Standard

Front pipe

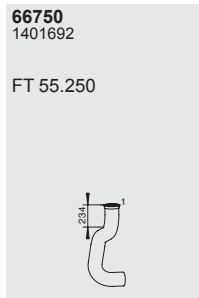
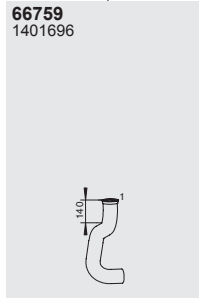

Silencer

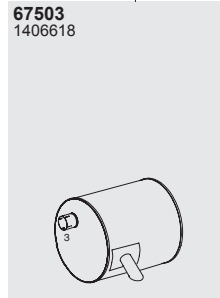

Mounting Parts

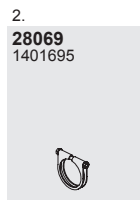
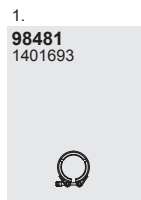

Series LF 55

Type

Euro III
01/2001 →

FA 55.170



13 ton.

BE 123C
3,9l tr.
4 cyl.
123K W/167H P

Front pipe

Silencer

Tail pipe

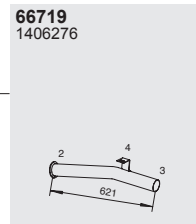
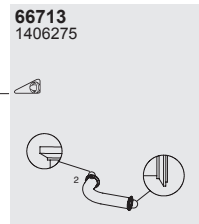
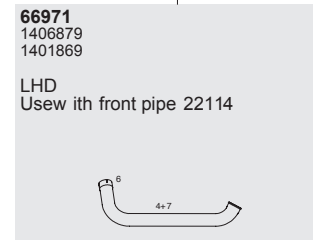
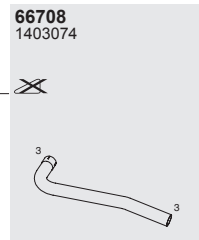
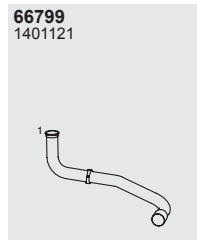
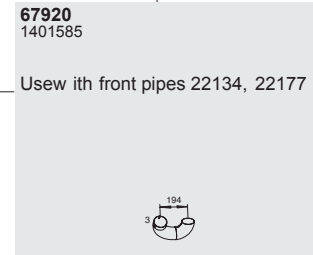
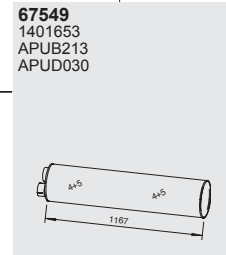
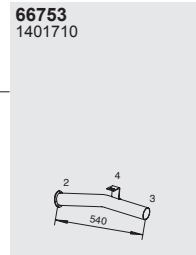
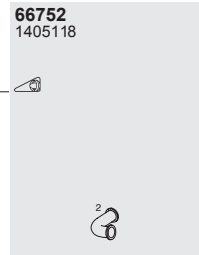
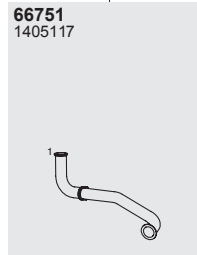

Mounting Parts

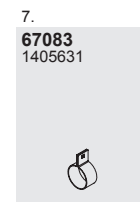
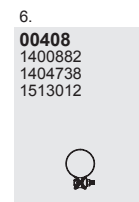
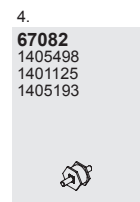
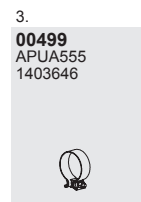
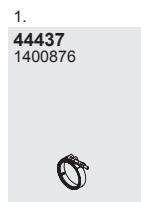

Horizontal
LHD/RHD
Standard

Series LF 55

Type

Euro III
01/2001 →



13 ton.
15 ton.
18 ton.

FA 55.180
FA 55.220
FA 55.250

FT 55.180
FT 55.220
FT 55.250

CE 136 C
5,9l tr.
6 cyl.
136K W/185H P

CE 162 C
5,9l tr.
6 cyl.
162K W/220H P

CE184 C
5,9l tr.
6 cyl.
184K W/250H P

Horizontal
LHD/RHD
Standard

Front pipe

66759
1401696

66754
1401697

FA/FT 55.180,220

66659
1407399

FA 55.180,220

66651
1406406

FA 55.180,220

66750
1401692

FA 55.180,220,250

66718
1402596

FA/FT 55.250

66626
1652615

FA 55.250

66627
1406608

FA 55.250

Silencer

67501
1401632
APUA563
APUD031
FA 55.180,220
FT 55.180,220

67502
1401636
APUB214
APUD032
FA/FT 55.250

Tail pipe

67924
1401584

Mounting Parts

1.
98481
1401693

2.
28069
1401695

3.
00408
1400882
1404738
1513012

4.
67082
1405498
1401125
1405193

5.
67481
1406719
1702273

6.
67448
1405189

6A.
67482
1408598

7.
67490
1405187

7A.
67476
1408599

8.
98489
1405190

9.
00085
1400923
1403150

10.
66482
1408540

Series LF 55

Type

Euro III
01/2001 →



13 ton.
15 ton.
18 ton.

FA 55.180
FA 55.220
FA 55.250

CE 136 C
5,9l tr.
6 cyl.
136K W/185H P

CE 162 C
5,9l tr.
6 cyl.
162K W/220H P

CE184 C
5,9l tr.
6 cyl.
184K W/250H P

Front pipe

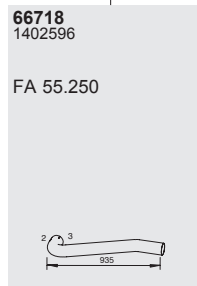
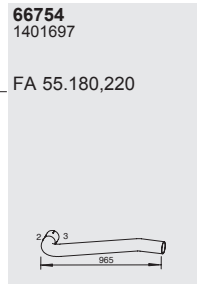
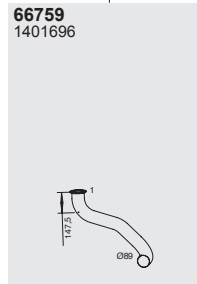

Silencer

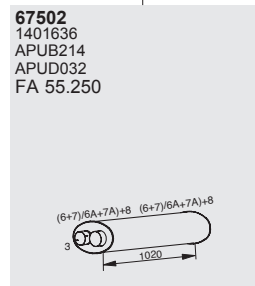
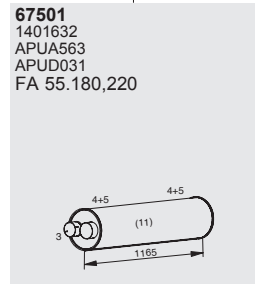

Tail pipe

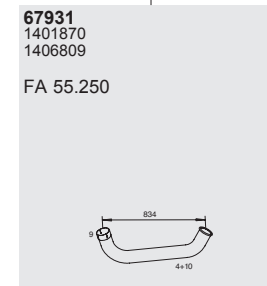
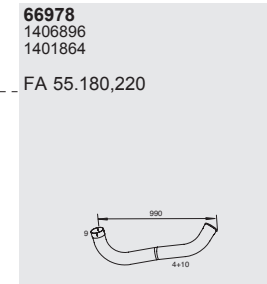
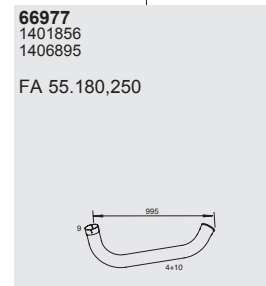
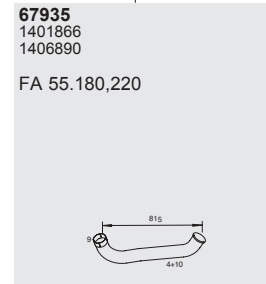

Mounting Parts

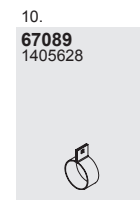
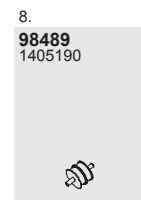
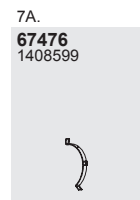
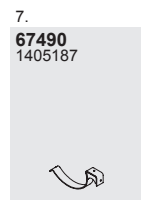
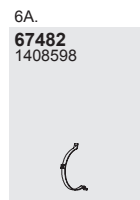
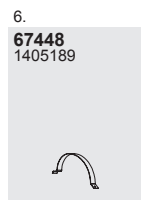
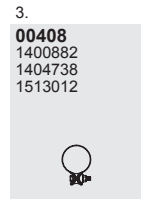
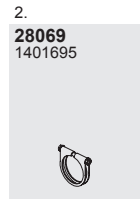
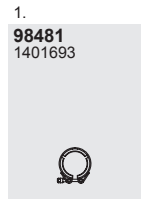

Horizontal
LHD
Standard

Series LF 55

Type

Euro III
01/2001 →



15 ton.
18 ton.

FA 55.250
FT 55.250

CE184 C
5,9l tr.
6 cyl.
184K W/250H P

Front pipe

66750
1401692

FA 55.250
FT 55.250

66759
1401696

FA 55.250

66718
1402596

66625
1406972

Silencer

67502
1401636
APUB214
APUD032

Tail pipe

67931
1401870
1406809

Mounting Parts

1.
98481
1401693

2.
28069
1401695

3.
00408
1400882
1404738
1513012

4.
67082
1405498
1401125
1405193

5.
67089
1405628

6.
67448
1405189

7.
67490
1405187

8.
98489
1405190

9.
00085
1400923
1403150

Horizontal
LHD
Standard

Series LF 55

Type

Euro III
01/2001 →

FT 55.250



15 ton.
18 ton.

CE 184C
5,9l tr.
6 cyl.
184K W/250H P

Front pipe

Silencer

Tail pipe

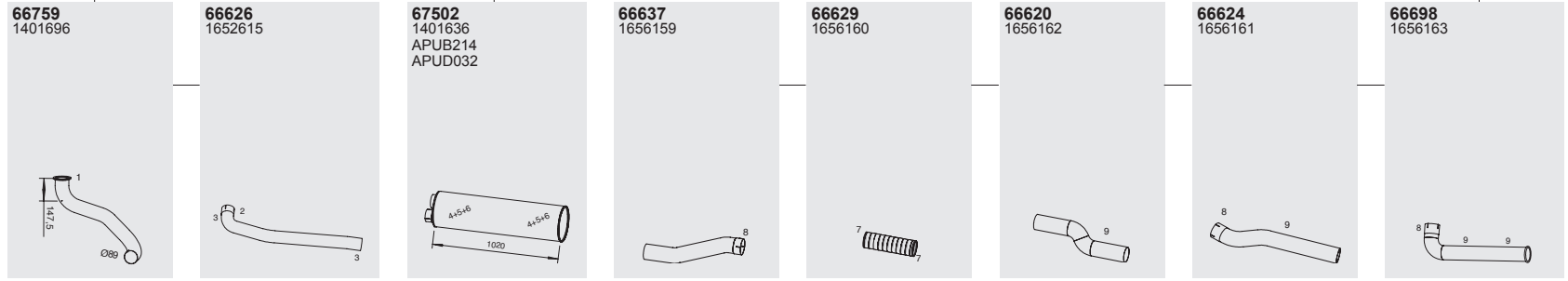

Mounting Parts

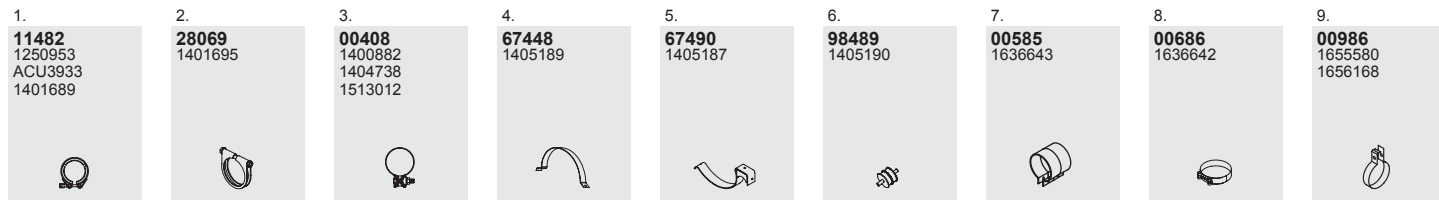

Horizontal
LHD
Standard

Series LF 55

Type

Euro III
01/2001 →



13 ton.
15 ton.
18 ton.

FA 55.180
FA 55.220
FA 55.250

CE 136 C
5,9l tr.
6 cyl.
136K W/185H P

CE 162 C
5,9l tr.
6 cyl.
162K W/220H P

CE184 C
5,9l tr.
6 cyl.
184K W/250H P

Front pipe

66759
1401696

66627
1406608

FA 55.250

66651
1406406

FA 55.180,220

66750
1401692

FA 55.180,220

66754
1401697

FA 55.180,220

Silencer

67501
1401632
APUA563
APUD031
FA 55.180,220

67502
1401636
APUB214
APUD032
FA 55.250

Tail pipe

67935
1401866
1406890

FA 55.180,220

67931
1401870
1406809

FA 55.250

66979
1406782

FA 55.250

Mounting Parts

1.
98481
1401693

2.
28069
1401695

3.
00408
1400882
1404738
1513012

4.
67082
1405498
1401125
1405193

5.
67491
1401634

6.
67448
1405189

7.
67490
1405187

8.
98489
1405190

9.
00085
1400923
1403150

10.
67089
1405628

Horizontal
LHD
Standard

Series 65/75

Type

Euro II

 65
75

Front pipeT

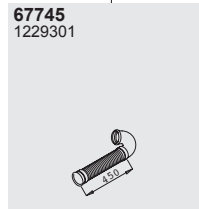
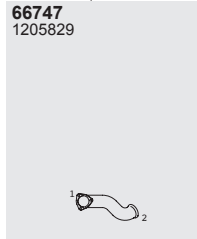

Silencer

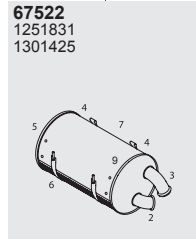

ail pipe

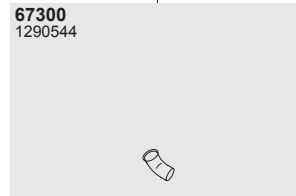
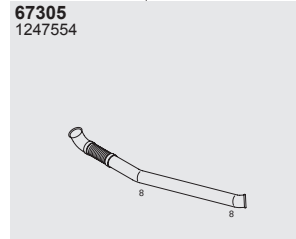

Mounting Parts

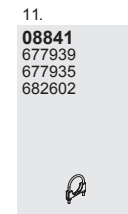
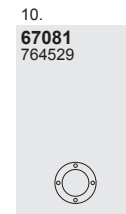
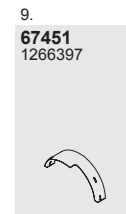
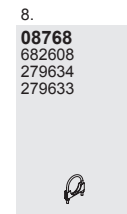
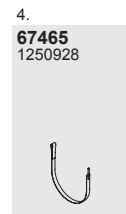
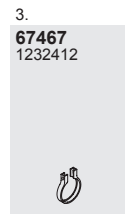
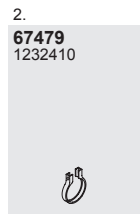
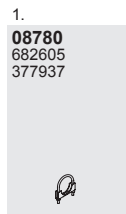

Horizontal
LHD
Standard

Series 75/85

Type

Euro II

 75

Front pipe

Silencer

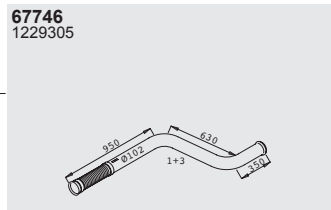
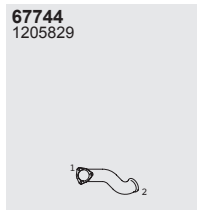
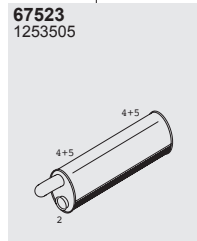
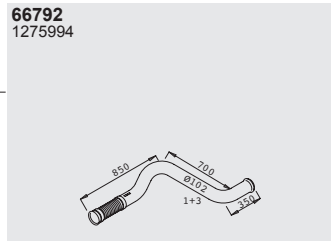
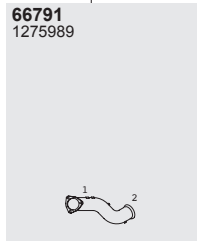

Mounting Parts

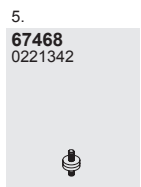
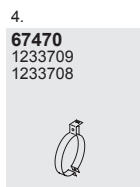
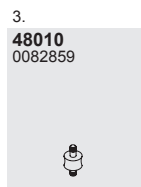
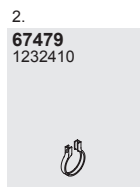
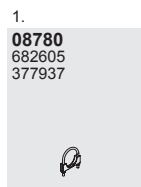

Horizontal
LHD
Standard

Series 75/85

Type

Euro II



75

Front pipe

67666
1270103



676665
1270121



67664
1274948

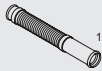

Silencer

67537
1255353

41 / 2"



Tail pipe

67302
1257823



67456
1274960



Mounting Parts

1.

67479
1232410



2.

08771
1283784



3.

08758
682610
1296068



4.

67458
1255360



67530
1294370

5"



67981
1294371



Vertical
LHD
Standard

Series 75/85

Type

Euro II



85

Front pipe

Silencer

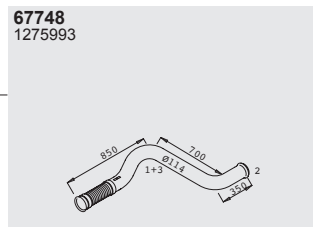
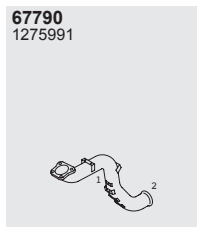
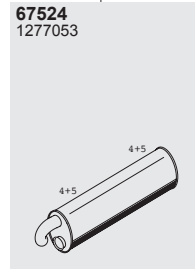
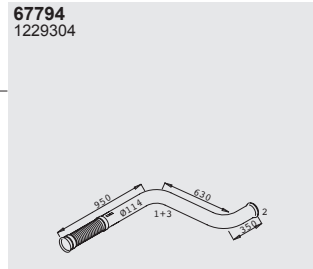
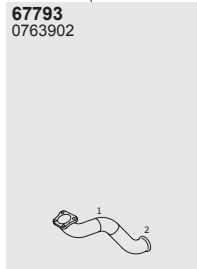

Mounting Parts

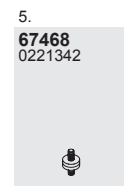
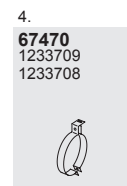
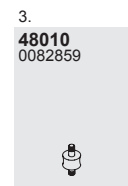
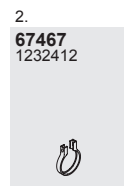

Horizontal
LHD
Standard

Series 75/85

Type

Euro II



85

Front pipeT

67793
0763902



67793
1229300



Silencer

67520
1229296

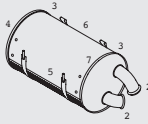

ail pipe

67305
1247554

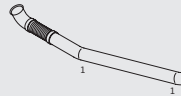

67300
1290544



Mounting Parts

1.

08768
682608
279634
279633



2.

67467
1232412



3.

67465
1250928



4.

67461
1248184



5.

67462
1208405



6.

67463
1208403



7.

67451
1266397



Horizontal
LHD
Standard

Series 75/85

Type

Euro II



85

Front pipe

67749
1270423

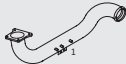

67707
1274955

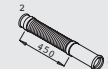

Silencer

67537
1255353

41 1/2"



67530
1294370

5"



Tail pipe

67302
1257823



67456
1274960



Mounting Parts

1.

67457
1303583



2.

67467
1232412



3.

08771
1283784



4.

67458
1255360



5.

08758
682610
1296068



Vertical
LHD
Standard

Series 65 CF

Type

Euro II



FA 65.180
FA 65.210
FA 65.240

Horizontal
LHD
Standard

Front pipe

67618
1306942
1324322
1376870



67650
1347277



67745
1229301

Excl.F A 65.180, FA 65.210



Silencer

67522
1251831
1301425

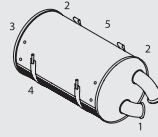

Tail pipe

67913
1346850

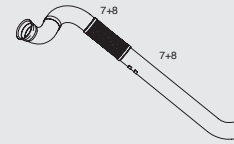

67300
1290544



67963
1290825

Excl.F A 65.180, FA 65.210

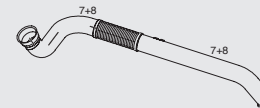

67919
1316485

Excl.F A 65.180, FA 65.210



Mounting Parts

1.

67479
1232410



2.

67494
1347373



3.

67461
1248184



4.

67499
1349227



5.

67463
1208403



6.

67467
1232412



7.

48010
0082859



8.

08780
682605
377937



Series CF 65

Type

Euro III
01/2001 →



18 ton.
19 ton.

FA 65.180M
FA 65.120M
FA 65.250M

CE 136 C
5,9l tr.
6 cyl.
136K W/185H P

CE 162 C
5,9l tr.
6 cyl.
162K W/220H P

CE 184C
5,9l tr.
6 cyl.
184K W/250H P

Front pipe

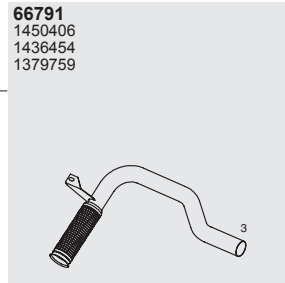
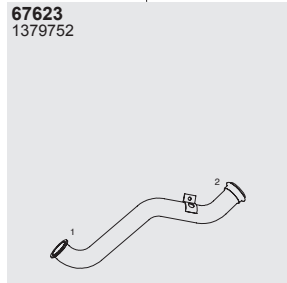

Silencer

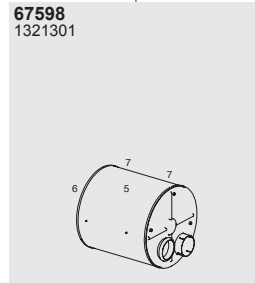

Tail pipe

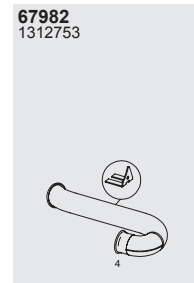
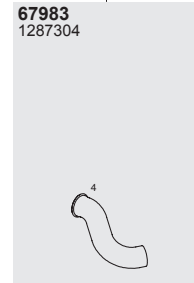

Mounting Parts

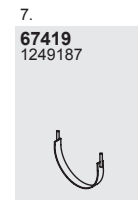
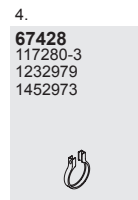
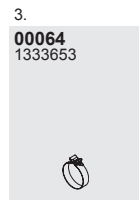
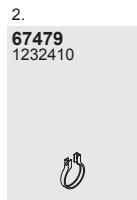
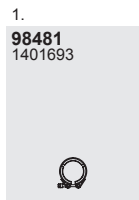

Horizontal
LHD/RHD
Standard

Series CF 65

Type

Euro III
01/2001 →



18 ton.
19 ton.

FA 65.220DA
FA 65.250DA

FA 65.180M
FA 65.120M
FA 65.250M

CE 136 C
5,9l tr.
6 cyl.
136K W/185H P

CE 162 C
5,9l tr.
6 cyl.
162K W/220H P

CE 184C
5,9l tr.
6 cyl.
184K W/250H P

Front pipeT

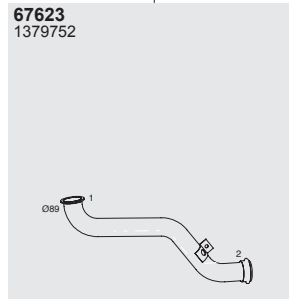

Silencer

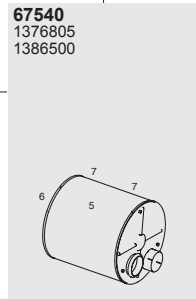

ail pipe

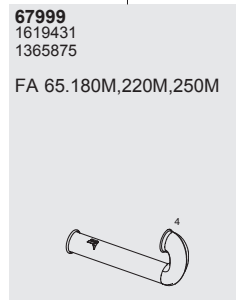
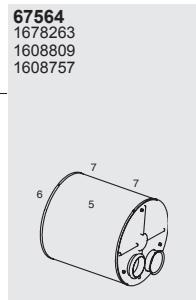
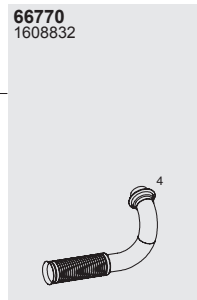

Mounting Parts

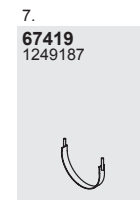
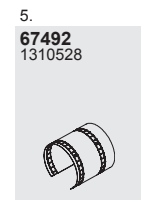
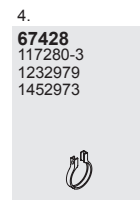
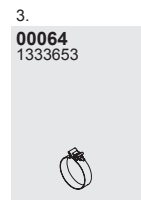
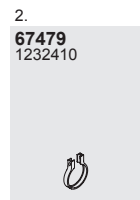
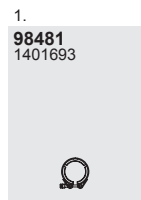

Horizontal
LHD/RHD
Standard

Series 75 CF

Type

Euro II



FAT 75.250
 FAT 75.290
 FAT 75.320
 FAV 75.250
 FAV 75.290
 FAV 75.320

Front pipe

Silencer

Tail pipe

67606
1380048

FAV

67692
1336981

FAT, FAV

67543
1318034

67969
1336641

FAT, FAV 75.250/320

67911
1333656

FAT 75.250

67695
1354960

FAT
FAV 75.290

67603
1356093

FAT 75.290

67955
1353311

FAT

67964
1333654

FAT
FAV 75.290

Mounting Parts

1.
67428
117280-3
1232979
1452973

2.
00064
1333653

3.
67419
1249187

4.
67414
1248785
1436185

5.
67496
1325072

67952
1353312

FAT 75.290

67951
1334821

FAT

Horizontal
LHD
Standard

Series 75 CF

Type

Euro II



FA 75.250
 FA 75.280
 FA 75.290
 FA 75.310
 FA 75.320
 FT 75.250
 FT 75.280
 FT 75.290
 FT 75.310
 FT 75.320

Front pipe

67608
1354955

FA,E xcl.F A 75.280

67692
1336981

FA,F T

67695
1354960

FA,F T, Excl.F A 75.310

Silencer

67543
1318034

Tail pipe

67956
1344814
1354957

FA 75.250/290

67951
1334821

FA 75.250

67911
1333656

FA 75.250/290

67964
1333654

FA 75.250/280/290/320
 FT 75.250/290/320

67960
1333655

FA 75.280/290/320
 FT 75.290/320

67969
1336641

FA 75.250/290/320
 FT 75.250/280/290/320

67915
1336904

FA 75.250/310/320
 FT 75.290/310

67955
1353311

FT 75.290

Mounting Parts

1.
67428
117280-3
1232979
1452973

2.
00064
1333653

3.
67419
1249187

4.
67414
1248785
1436185

5.
67496
1325072

Horizontal
 LHD
 Standard

Series 75 CF

Type

Euro II



FAG 75.250
 FAG 75.280
 FAG 75.290
 FAG 75.320
 FAN 75.250
 FAN 75.290
 FAN 75.320
 FAR 75.250
 FAR 75.290
 FAR 75.320
 FAS 75.250
 FAS 75.290
 FAS 75.320

Front pipe

67695
1354960

FAG, FAN, FAR, FAS

67691
1345251

FAG

67608
1354955

FAR, FAS

67692
1336981

FA,F AG,F AN,F AR,F AS,
FAT, FT

Silencer

67543
1318034

Tail pipe

67969
1336641

FAG, FAN, FAR, FAS

67964
1333654

FAN, FAR, FAS

67957
1354108

FAG 75.250/290

67958
1354106

FAG 75.250/290/320

67911
1333656

FAS 75.290

67960
1333655

FAS 75.320

Mounting Parts

1.
67428
117280-3
1232979
1452973

2.
00064
1333653

3.
67419
1249187

4.
67414
1248785
1436185

5.
67496
1325072

67951
1334821

FAS 75.290

Horizontal
LHD
Standard

Series 75 CF

Type

Euro II



- FA 75.250
- FA 75.290
- FA 75.320
- FAG 75.250
- FAG 75.290
- FAG 75.320
- FAN 75.290
- FAN 75.320
- FAS 75.250
- FAS 75.290
- FAS 75.320
- FAT 75.250
- FAT 75.290
- FAT 75.320
- FT 75.320

Front pipe

67693
1355828

67610

67628
1349905

67622
1349904

Silencer

67537
1255353

41 / 2"

67530
1294370

5"

Tail pipe

67302
1257823

67456
1274960

Mounting Parts

67467

2.
08771
1283784

3.
08758
682610
1296068

4.
67458
1255360

Vertical
LHD/RHD
Right

Series 85 CF

Type

Euro II



- FA 85.340
- FAC 85.340
- FAG 85.340
- FAN 85.340
- FAR 85.340
- FAS 85.340
- FAT 85.340

Front pipe

67662
1292569

67646
1331950

FA, FAC, FAG, FAN, FAR, FAS, FAT

67648
1331959

FA, FAC, FAG, FAN, FAR, FAS, FAT

67649
1354284

FA, FAC, FAG, FAN, FAR, FAS, FAT

67624
1333578

FA, FAS

Silencer

67543
1318034

Tail pipe

67969
1336641

FA, FAC, FAG, FAN, FAR, FAS, FAT

67964
1333654

FA, FAN, FAR, FAS

67960
1333655

FA, FAR, FAS

67958
1354106

FAG

67951
1334821

FAT

Mounting Parts

1.
10459
1302930

2.
00064
1333653

3.
674428
117280-3
1232979
1452973

4.
67419
1249187

5.
67496
1325072

6.
67414
1248785
1436185

Horizontal
LHD
Standard

Series 85 CF

Type

Euro II



④X②
⑥X②
⑥X④

FA 85.380
FAG 85.380
FAN 85.380
FAR 85.380
FAS 85.380
FAT 85.380

Horizontal
LHD
Standard

Front pipe

67662
1292569



67645
1331949

FA, F AR, FAS

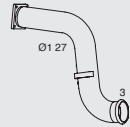

67648
1331959

FA, F AG, F AN, F AR, F AS, F AT

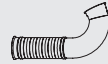

67642
1350538
1354266

FA, F AG, F AN, F AR, F AS, FAT

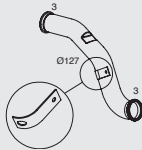

67624
1333578

FA, F AR, FAS

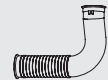

67690
1350540

FAR, FAS

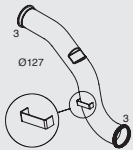

67604
1395716

FAT

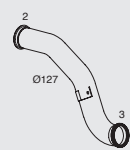

Silencer

67543
1318034

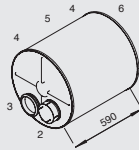

Tail pipe

67964
1333654

FA, F AR, F AS, F AT

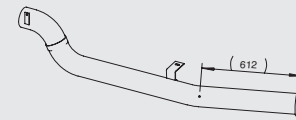

67969
1336641

FA, F AG, F AN, F AR, FAS, FAT



67958
1354106

FAG

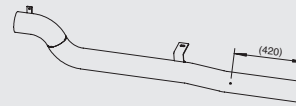

67951
1334821

FAT

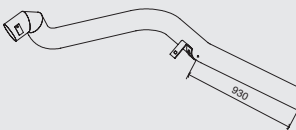

Mounting Parts

1.

10459
1302930



2.

00063
1333653



3.

67428
117280-3
1232979
1452973



4.

67419
1249187



5.

67496
1325072



6.

67414
1248785
1436185



Series 85 CF

Type

Euro II



④X②
⑥X②
⑥X④

FA 85.430
FAG 85.430
FAN 85.430
FAR 85.430
FAS 85.430
FAT 85.430

Horizontal
LHD
Standard

Front pipe

67662
1292569



67645
1331949

FA,F AN,F AR, FAS

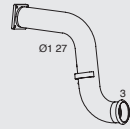

67648
1331959

FA,F AG,F AN,F AR,F AS,F AT

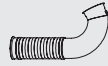

Silencer

67543
1318034

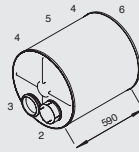

Tail pipe

67964
1333654

FA,F AN,F AR,F AS,F AT

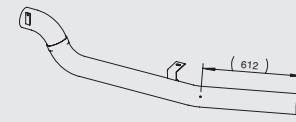

67969
1336641

FA,F AR,F AS,F AT



67642
1350538
1354286

FA,F AG,F AN,F AR,F AS, FAT

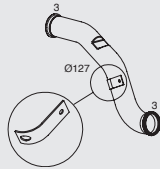

67624
1333578

FA,F AN,F AR, FAS

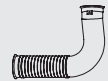

67958
1354106

FAG

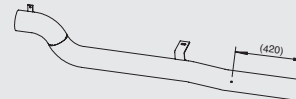

67690
1350540

FAR, FAS

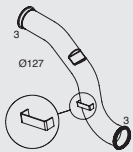

67604
1395716

FA,F AR, FAS

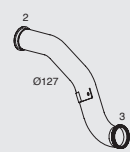

67951
1334821

FAT

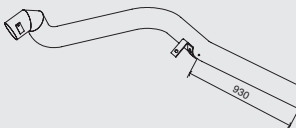

Mounting Parts

1.

10459
1302930



2.

00064
1333653



3.

67428
117280-3
1232979
1452973



4.

67419
1249187



5.

67496
1325072



6.

67414
1248785
1436185



Series 85 CF

Type

Euro II



FT 85.340
 FT 85.380
 FT 85.430
 FTT 85.340
 FTT 85.380
 FTT 85.430

Horizontal
 LHD
 Standard

Front pipe

67662
1292569

67646
1331950

FT, FTT 85.340, FT 85.380

67648
1331959

67543
1318034

67969
1336641

Excl.F TT 85.340

67952
1353312

FT 85.340

67642
1350538
1354286

FT, FTT 85.380/85.430

67604
1395716

FT,F TT 85.380/85.430

67915
1336904

FT 85.340/85.380

67955
1353311

FT 85.340/85.380/85.430

67690
1350540

FT 85.380/85.430

67649
1354284

FT, FTT 85.340, FT 85.380

67964
1333654

67960
1333655

FT 85.340/85.380

Silencer

Tail pipe

Mounting Parts

1.
10459
1302930

2.
00064
1333653

3.
67428
117280-3
1232979
1452973

4.
67419
1249187

5.
67496
1325072

6.
67414
1248785
1436185

Series CF 75

Type

Euro III
01/2001 →



FA 75.250Q
FA 75.310Q
FA 75.360Q



FAN 75.250Q
FAN 75.310Q
FAN 75.360Q
FAR 75.250Q
FAR 75.310Q
FAR 75.360Q
FAS 75.250Q
FAS 75.310Q
FAS 75.360Q



FAT 75.250Q
FAT 75.310Q
FAT 75.360Q



FT 75.250Q
FT 75.310Q
FT 75.360Q

PE 183C /
PR 183 S
PE 228 C/
PR 228 S
PE 265S /
PR 265 C
12,6l tr.
6 cyl.
183K W/250H P
223K W/310H P
265K W/360H P

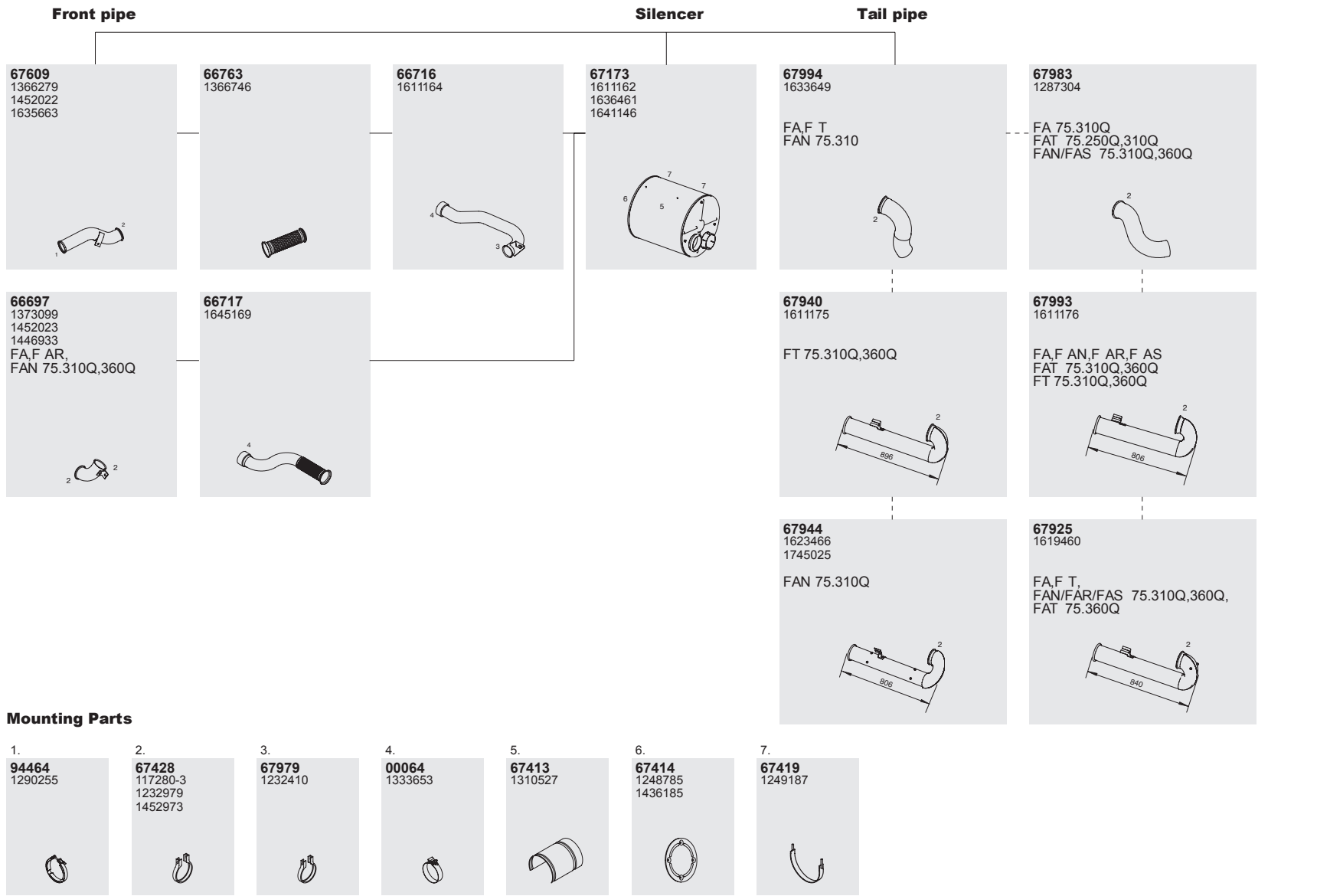

Horizontal
LHD/RHD
Standard

Series CF 75

Type

Euro III
01/2001 →



FA 75.250Q
FA 75.310Q
FA 75.360Q



FAN 75.250Q
FAN 75.310Q
FAN 75.360Q
FAR 75.250Q
FAR 75.310Q
FAR 75.360Q
FAS 75.250Q
FAS 75.310Q
FAS 75.360Q



FAT 75.250Q
FAT 75.310Q
FAT 75.360Q



FT 75.250Q
FT 75.310Q
FT 75.360Q

PE 183C /
PR 183 S
PE 228 C/
PR 228 S
PE 265S /
PR 265 C

12,6l tr.
6 cyl.
183K W/250H P
223K W/310H P
265K W/360H P

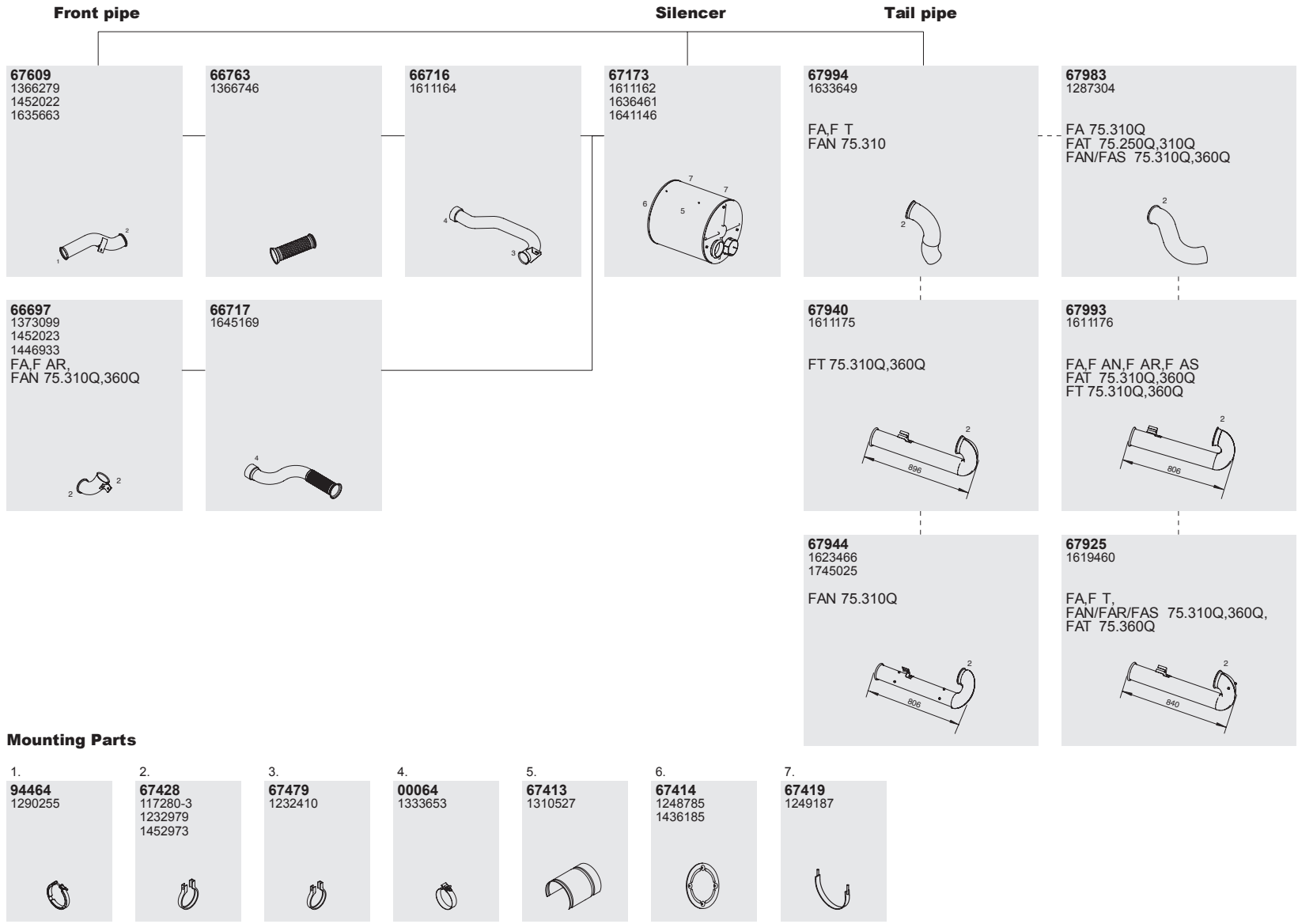

Mounting Parts

Horizontal
LHD/RHD
Standard

Series CF 75

Type

Euro III
01/2001 →



FA 75.250Q
FA 75.310Q
FA 75.360Q



FAN 75.250G
FAN 75.310Q
FAN 75.360Q
FAR 75.250Q
FAR 75.310Q
FAR 75.360Q
FAS 75.250Q
FAS 75.310Q
FAS 75.360Q



FAT 75.250Q
FAT 75.310Q
FAT 75.360Q



FT 75.250Q
FT 75.310Q
FT 75.360Q

PE183C/PR183S

PE228C/PR228S

PE265S/PR265C

12,6l tr.
6 cyl.
183K W/250H P
223K W/310H P
265K W/360H P

Horizontal
LHD/RHD
Standard

Front pipeS

67609
1366279
1452022
1635663



66763
1366746



66767
1371236
1436455
1450407

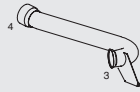

66768
1394023
1450409

FA 75.250Q, F AN, FAT 75.310Q, 360Q,
FT 75.250Q

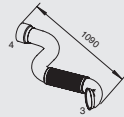

66697
1373099
1452023
1446933



66763
1366746



66767
1371236
1436455
1450407

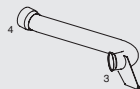

66639
1611332

FAN 75.250Q

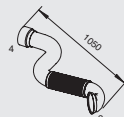

ilencer

67598
1321301

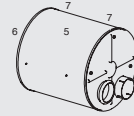

Tail pipe

67983
1287304

Excl.F AN/FAT 75.360Q



67982
1312753

Excl.F AT 75.250Q

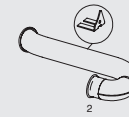

Mounting Parts

1.
94464
1290255



2.
67428
117280-3
1232979
1452973



3.
67479
1232410



4.
00064
1333653



5.
67413
1310527



6.
67414
1248785
1436185





7.
67419
1249187







Series CF 75



Type



Euro III
01/2001 →

 
FA 75.250Q
FA 75.310Q
FA 75.360Q
FAG 75.310Q

 
FAN 75.250G
FAN 75.310Q
FAN 75.360Q
FAR 75.310Q
FAS 75.250Q
FAS 75.310Q
FAS 75.360Q

 
FAT 75.250Q
FAT 75.310Q
FAT 75.360Q

 
FT 75.250Q
FT 75.310Q
FT 75.360Q

 **PE 183C / PR 183 S**
 **PE 228 C/ PR 228 S**
 **PE 265S / PR 265 C**
12,6l tr.
6 cyl.
183K W/250H P
223K W/310H P
265K W/360H P

Horizontal
LHD/RHD
Standard

Front pipe

Silencer

Tail pipe

66791
1373099
1452023
1446933



66777
1608834

Excl.F AR
Excl.F AT 75.250Q



67564
1678263
1608809
1608757

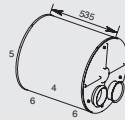

66962
1619429

FT 75.360Q



67609
1366279
1452022
1635663



66778
1427010
1366281

Excl.F AT 360Q



67540
1376805
1386500

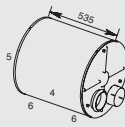

67999
1619431
1365875

Excl.F AG,F AR
Excl.F AT 75.250Q,360Q



67991
1438306
1639953

Excl.F AS 75.250Q
Excl.F AN/FAT 75.360Q



66748
1607869
1674709

FAT 75.305DA



66742
1443236



66747
1607868



Mounting Parts

1.
94464
1290255



2.
67428
117280-3
1232979
1452973



3.
00064
1333653



4.
67492
1310528



5.
67141
1248785
1436185



6.
67419
1249187



Series CF 75/CF 85

Type

Euro III
01.2001 →

CF 75

FAD 75.250Q
FAD 75.360Q

PE 183C
 PR 183S
9,2l tr.
6 cyl.
183K W/249H P
265K W/360H P

CF 85

FA 85.330W
FA 85.380X
 FAC 85.340S
FAC 85.380S
FAC 85.430S
FAC 85.480S

FAD8 5 340S
FAD 85.380S
FAD 85.430S
FAD8 5 480S

FAX 85.340S
FAX 85.380S
FAX8 5 430S
FAX 85.480S
 FTG 85.360W

XE250C/280C
 XE315C/355C
12,6l tr.
6 cyl.
250K W/340H P
280K W/381H P
315K W/428H P
355K W/483H P

Vertical
LHD/RHD
Standard

Front pipe

67612
1344053
1428367
1629454
CF8 5



66722
1600803
1425332
CF8 5
FAD, FAX, FTG



66723
1600806
1425334
CF8 5
Excl. FTG



67609
1366279
1452022
1635663
CF7 5

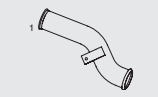

66789
1442482
CF7 5



Silencer

67544
1440883

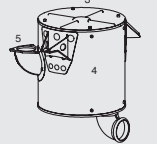

67286
1443454
CF8 5
Excl.F A 85.330W
Excl. FTG



67287
1444480
FA 85.330W
FAC 85.430S/480S
FAD 85.340S/380S/430S/480S
FAX 85.380S/430S/480S



67288
144495
FAD, Excl.F AD 75.250Q
FAX 85.340S/380S/430S



Tail pipe

67981
1294371



67965
1435937
1459230

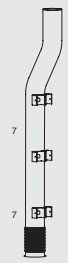

Mounting Parts

1.
94464
1290255



2.
67428
117280-3
1232979
1452973



3.
67414
1248785
1436185



4.
67430
1452203



5.
67486
1442579



6.
00958
1296068



7.
67442
1296070



Series CF 75/CF 85

Type

Euro III
01.2001 →

CF 75

1366279
1452022
1635663
CF 75
FAD 75.250Q
FAD 75.360Q

PE 183 C/
PR 183 S
PE 265C /
PR 265S
9,2l tr.
6 cyl.

183K W/249H P
265K W/360H P

CF 85

1344053
1428367
1629454
CF 85
FAC 85.340S
FAC 85.380S
FAC 85.430S
FAC 85.480S

FAD8 5 340S
FAD 85.380S
FAD 85.430S
FAD8 5 480S

FAN 85.430S
FAX 85.340S
FAX 85.380S
FAX8 5 430S
FAX 85.480S

XE250C/280C
XE315C/355C

12,6l tr.
6 cyl.
250K W/340H P
280K W/381H P
315K W/428H P
355K W/483H P

Horizontal
LHD/RHD
Standard

Front pipeT

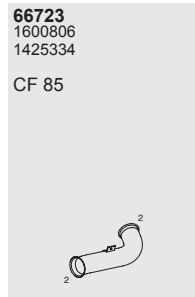
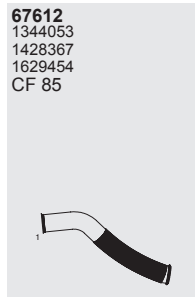
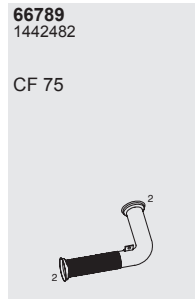
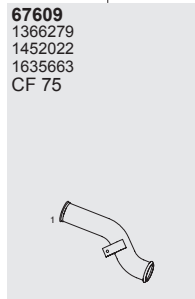

Silencer

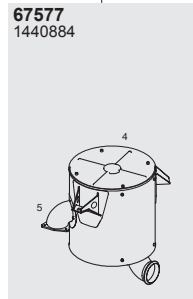

ail pipe

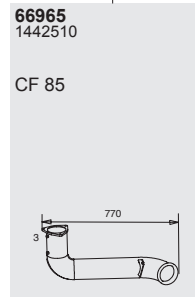
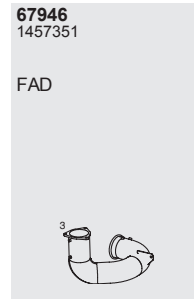
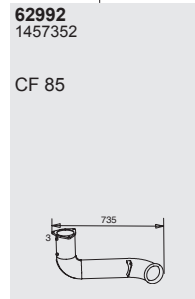

Mounting Parts

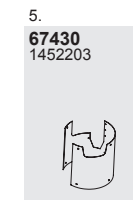
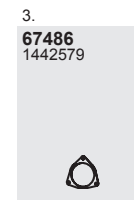
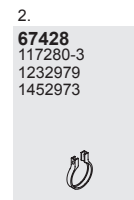
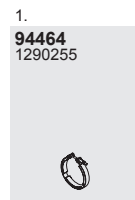

Series CF 75/CF 85

Type

Euro III
01/2001 →



CF 75

FAG 75.310Q

PE 228C
PR 228C
9,2l tr.
6 cyl.
228K W/310H P

CF 85

FTG 85.340S
FTG 85.380S
FTG 85.430S

FTP 85.430S
FTP 85.480S

XE 250C
XE 280C
XE 315C
XE 355C
12,6l tr.
6 cyl.
250K W/340H P
280K W/381H P
315K W/428H P
355K W/483H P

Front pipe

67612
1344053
1428367
1629454
CF 85

66636
1608841
FTG

67609
1366279
1452022
1635663
CF 75

66696
1608837
CF 75

66736
1453063
1386902
CF 85

66632
1386332
1427017
FTG

66635
1425335
1427013
CF 75

Silencer

67151
1389453
CF 85

67152
1608759
1608811
FAG, FTG

66287
1427380
CF 85

66286
1392096
FTG

NA
1394059
CF 75

Tail pipe

67965
1435937
1459230

67981
1294371

Mounting Parts

1.
94464
1290255

2.
67428
117280-3
1232979
1452973

3.
00958
1296068

4.
66480
1380426

5.
66478
1380427

6.
67414
1248785
1436185

7.
67419
1249187

8.
67442
1296070

Vertical
LHD/RHD
Standard

Series CF 85

Type

Euro III
01/2001 →

- FA 85.380S
- FA 85.430S
- FAD 85.340X
- FAD 85.380X
- FAD 85.430X
- FAN 85.340S
- FAN 85.380S
- FAN 85.430S
- FAN 85.480S
- FAR 85.340S
- FAR 85.380S
- FAR 85.430S
- FAR 85.480S
- FAS 85.340S
- FAS 85.380S
- FAS 85.430S
- FAS 85.480S
- FAT 85.340S
- FAT 85.380S
- FAT 85.430S
- FAT 85.480S
- FT 85.340S
- FT 85.380S
- FT 85.430S
- FT 85.480S
- FTP 85.340S
- FTP 85.380S
- FTP 85.430S
- FTP 85.480S
- FTS 85.340S
- FTS 85.380S
- FTS 85.430S
- FTS 85.480S
- FTT 85.380S
- FTT 85.430S

- ☞ XE 250C
- ☞ XE 280C
- ☞ XE 315C
- ☞ XE 355C
- 12,6l tr.
- 6 cyl.
- 250K W/340H P
- 280K W/381H P
- 315K W/428H P
- 355K W/483H P

Horizontal
LHD/RHD
Standard

Front pipe

67612
1344053
1428367
1629454



66729
1610673

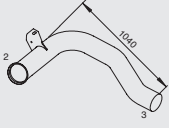

66725
1428369
1629456
1381559
FA,FAN
FAR 85.340S,380S
FAT 85.430S
FAS 85.430S
FT 85.430S,F TS 85.480S



66724
1611170

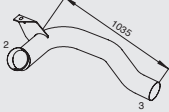

Silencer

67173
1611162
1636461
1641146

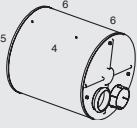

Tail pipe

67993
1611176

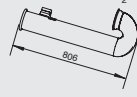

67983
1287304

FA/FAR 85.340S
FAN 85.340S,430S
FAS/FAT 85.430S,
FT 85.340S,380S,430S
FTP 85.380S,430S,480S
FTT 85.380S



67940
1611175

FT

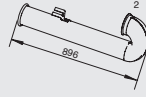

67944
1623466
1745025

FAN 85.430S
FT 85.380S,430S,480S

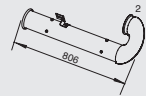

67991
1438306
1639953

FT 85.430S



67908
1623596

FT 85.430S

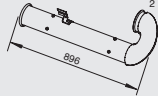

67994
1633649

FA 85.340S,380S
FAN 85.340S,430S
FAR 85.340S
FAS 85.380S,430S
FAT 85.430S
FT 85.340S,380S,430S
FTP 85.380S,430S,480S
FTT 85.380S



Mounting Parts

1.
94464
1290255



2.
67428
117280-3
1232979
1452973



3.
00064
1333653



4.
67413
1310527



5.
67414
1248785
1436185



6.
67419
1249187



Series CF 85

Type

Euro III
01/2001 →

- FA 85.340S
- FA 85.380S
- FA 85.430S
- FAG 85.340X
- FAG 85.380X
- FAG 85.430X
- FAN 85.340S
- FAN 85.380S
- FAN 85.430S
- FAR 85.340S
- FAR 85.430S
- FAS 85.340S
- FAS 85.380S
- FAS 85.430S
- FAS 85.480S
- FAT 85.340S
- FAT 85.380S
- FAT 85.430S
- FAT 85.480S
- FT 85.340S
- FT 85.380S
- FT 85.430S
- FT 85.480S
- FTG 85.430X
- FTP 85.380S
- FTP 85.430S
- FTP 85.480S
- FTS 85.430S
- FTT 85.430S
- FTT 85.480S

- ☞ **XE 250C**
- ☞ **XE 280C**
- ☞ **XE 315C**
- ☞ **XE 355C**
- 12,6l tr.
- 6 cyl.
- 250K W/340H P
- 280K W/381H P
- 315K W/428H P
- 355K W/483H P

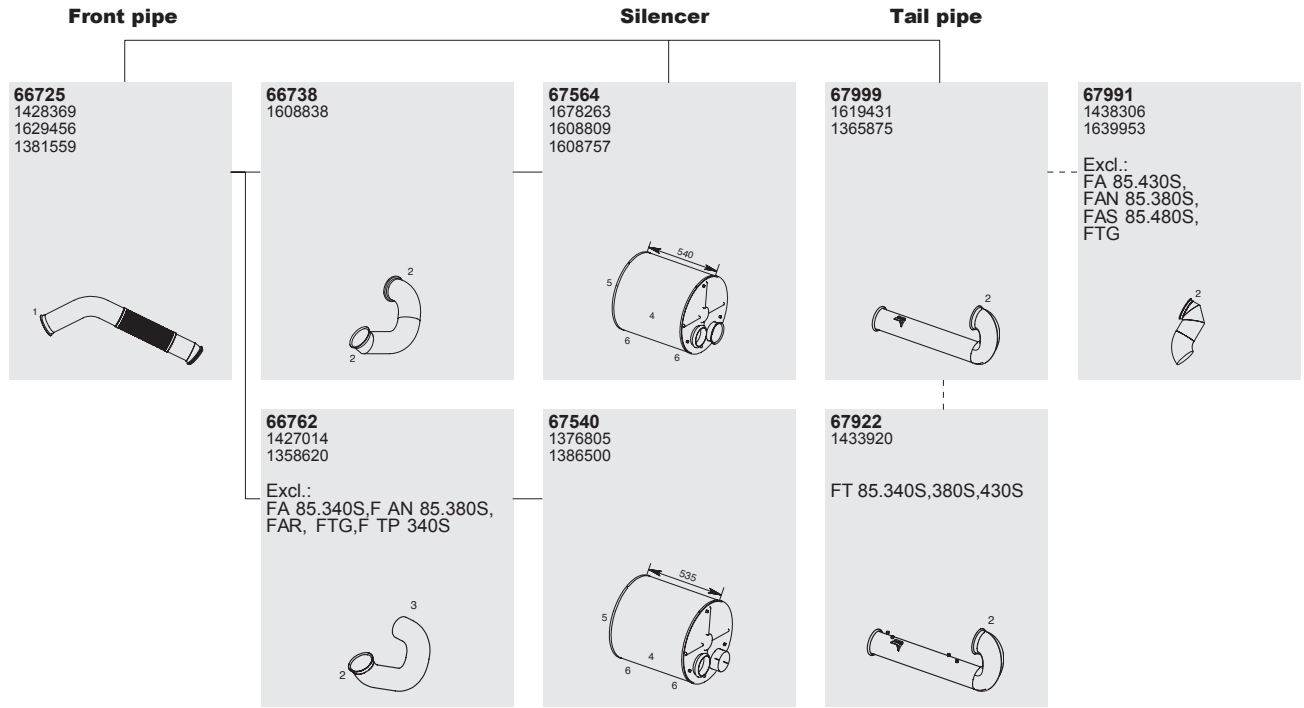

Mounting Parts

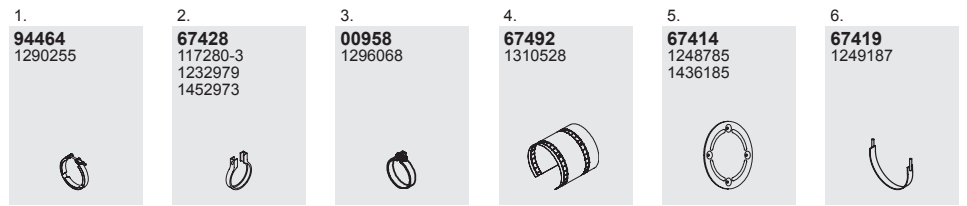

Horizontal
LHD/RHD
Standard

Series CF 85

Type

Euro III
01/2001 →

Ⓢ④
FAT 85.380S
FAT 85.380X
FAT 85.430S

Ⓢ②/④
FTG 85.380S
FTG 85.430S
FTG 85.430X
FTG 85.480S

Ⓢ XE 280C
Ⓢ XE 315C
Ⓢ XE 355C
12,6l tr.
6 cyl.
280K W/381H P
315K W/428H P
355K W/483H P

Front pipe

Silencer

Tail pipe

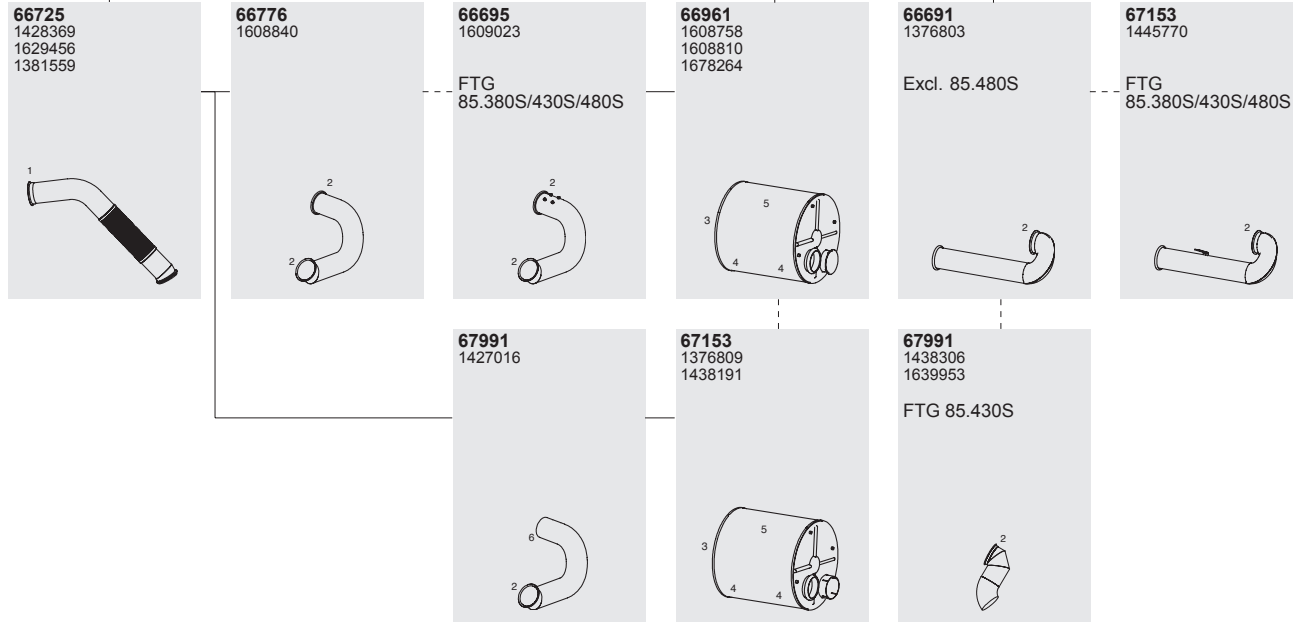

Mounting Parts

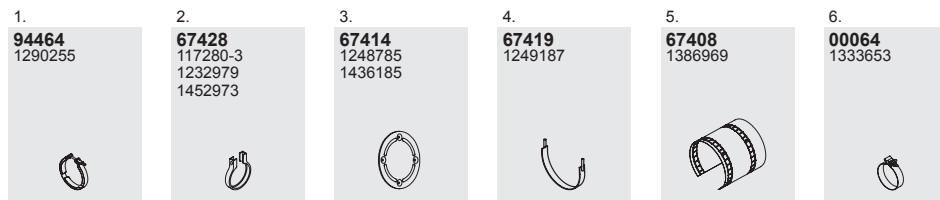

Horizontal
LHD/RHD
Standard

Series CF 85

Type

Euro III
01/2001 →

- FA 85.340S
- FA 85.380S
- FA 85.430S
- FA 85.480S
- FAG 85.340X
- FAG 85.380X
- FAG 85.430X
- FAN 85.340S
- FAN 85.380S
- FAN 85.430S
- FAN 85.480S
- FAR 85.340S
- FAR 85.380S
- FAR 85.430S
- FAR 85.480S
- FAS 85.340S
- FAS 85.380S
- FAS 85.430S
- FAS 85.480S
- FAT 85.340S
- FAT 85.380S
- FAT 85.430S
- FAT 85.480S
- FT 85.340S
- FT 85.380S
- FT 85.430S
- FT 85.480S
- FTG 85.340S
- FTG 85.380S
- FTG 85.430S
- FTP 85.380S
- FTP 85.430S
- FTP 85.480S
- FTS 85.380S
- FTS 85.430S
- FTS 85.480S
- FTT 85.380S
- FTT 85.430S
- FTT 85.480S
- XE 250C,280C
- XE 315C,355C
- 12,6l tr., 6 cyl.
- 250K W/340H P
- 280K W/381H P
- 315K W/428H P
- 355K W/483H P

Horizontal
LHD/RHD
Standard

Front pipeT

66725
1428369
1629456
1381559
FA,FAN,FAR,FAS



66735
1453061
123456
1381558

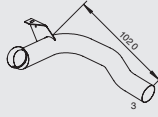

67612
1344053
1428367
1629454



66720
1453059
1364858
Excl.F AG
Excl.F A/FTG 85.480S

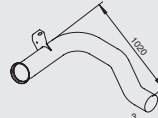

66736
1453063
1386902
FAG, FTG



Silencer

67598
1321301
Excl.F AG, FTG

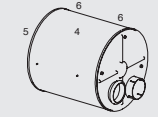

67172
1321303
1675733
FAG, FAR,FAT,FTG,
FAS/FTS 85.430S,
FTT 85.380S,430S



ail pipe

67982
1312753
Excl.F AG, FTG



67953
1310235
1312651
1617723
FAG, FTG

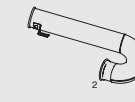

67983
1287304
Excl.F AG, FTS
Excl.F A,FAN,FAS,FT,FTT
85.480S



67921
1624532
FT 85.430S

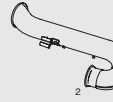

Mounting Parts

1.
94464
1290255



2.
67428
117280-3
1232979
1452973



3.
00958
1296068



4.
67413
1310527



4A.
67492
1310528



5.
67414
1248785
1436185



6.
67419
1249187



Series CF 85

Type

Euro III
01/2001 →

- FA 85.340S
- FA 85.380S
- FA 85.430S
- FAG 85.340S
- FAG 85.380S
- FAG 85.430S
- FAN 85.340S
- FAN 85.380S
- FAN 85.430S
- FAN 85.480S
- FAR 85.340S
- FAR 85.380S
- FAR 85.430S
- FAR 85.480S
- FAS 85.340S
- FAS 85.380S
- FAS 85.430S
- FAS 85.480S
- FAT 85.340S
- FAT 85.380S
- FAT 85.430S
- FAT 85.480S
- FT 85.340S
- FT 85.380S
- FT 85.430S
- FT 85.480S
- FTS 85.430S
- FTP 85.430S
- FTT 85.380S
- FTT 85.430S
- FTT 85.480S

- ☞ XE 250C
- ☞ XE 280C
- ☞ XE 315C
- ☞ XE 355C
- 12,6l tr.
- 6 cyl.
- 250K W/340H P
- 280K W/381H P
- 315K W/428H P
- 355K W/483H P

Vertical
LHD/RHD
Standard

Front pipes

66725
1428369
1629456
1381559
FA 85.340S,380S
FAN 85.380S

67612
1344053
1428367
1629454

66692
1620895
Usew ith
Middlep ipel I
1394059

66715
1608839

66647
1427015
1386221

ilencer

67515
1608760
1608812
1389455

66634
1392380
FT 85.340S/380S/430S
FTT

66286
1392096
Excl.F AG/FAS 85.340S,
Excl.F AR 85.340S,380S,

N A

1394059
FA,F AG,F AN,
FAR, FAS, FAT,
Excl.F AR/FAS 85.480S

Tail pipe

67965
1435937
1459230

67981
1294371

Mounting Parts

1.
94464
1290255

2.
67428
117280-3
1232979
1452973

3.
00958
1296068

4.
66484
1380428

5.
67414
1248785
1436185

6.
67419
1249187

7.
67442
1296070

Series 95

Type

Euro II



1996 →

Front pipe

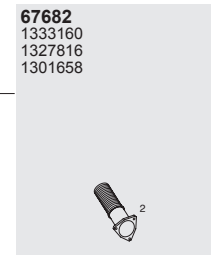
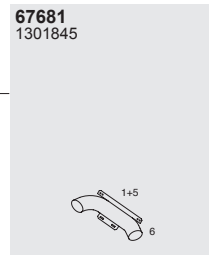
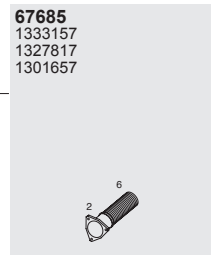
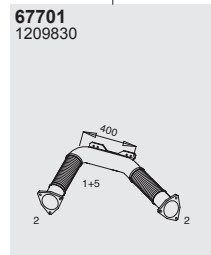
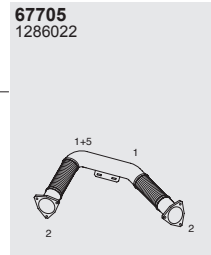
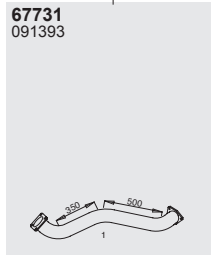

Silencer

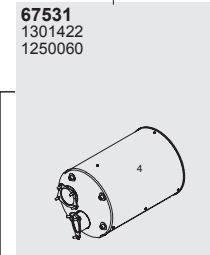

Tail pipe

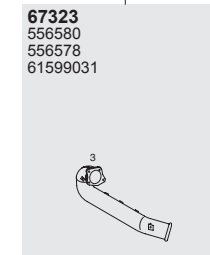

Mounting Parts

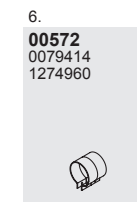
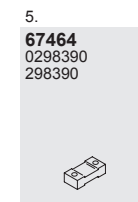
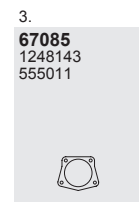

Horizontal
LHD
Standard

Series 95 XF

Type

Euro II



FA 95.380
FA 95.430
FA 95.480



FAR 95.380
FAR 95.430
FAR 95.480
FAS 95.380
FAS 95.430
FAS 95.480



FAT 95.380
FAT 95.430
FAT 95.480

Front pipe

67662
1292569

67671
1334252
1296778
1428366
FA, FAR, FAS, FAT 95.480

67663
1334251
1293071
1428365
Excl.F A, FAR, FAS, FAT 95.480

67612
1344053
1428367
1629454
Excl.F AT 95.380/430

67619
1349555
1428368
FAT 95.380/430

67605
1332845
Excl.F AT 95.380/430/480

67675
1322830
FA 95.480, FAR 95.480, FAS 95.480, FAT 95.430/480

67641
1326295
FA 95.480, FAR 95.380, FAS 95.480

Silencer

67598
1321301

Tail pipe

67918
1316120
FA 95.480, FAR 95.380

67982
1312753

67950
1331936
FA 95.480

67917
1342965
FAR 95.380

67954
1347652
FAS 95.480

67983
1287304
Excl.F AT 95.380

Mounting Parts

1.
67428
117280-3
1232979
1452973

2.
67413
1310527

3.
67419
1249187

4.
67414
1248785
1436185

5.
00564T
1296068

6.
67422
1302930

7.
94464
1290255

Horizontal
LHD
Standard

Series 95 XF

Type

Euro III



FT 95.380
FT 95.430
FT 95.480



FTG 95.380
FTG 95.430
FTG 95.480
FTR 95.380
FTR 95.430
FTR 95.480
FTS 95.380
FTS 95.430
FTS 95.480



FTT 95.380
FTT 95.430
FTT 95.480

Front pipe

67662
1292569

67663
1334251
1293071
1428365
FTG 95.380/430, FTT 95.380

67671
1334252
1296778
1428366
Excl. F T 95.380, FTG 95.380/430, FTT 95.380/430

67612
1344053
1428367
1629454
Excl. FTG 95.380/430, FTT 95.380

67619
1349555
1428368
FTG 95.380/430, FTT 95.380

67607
1343234
1323690
FTG 95.380/430/480

67675
1322830
Excl. FTG 95.380/430/480, FTT 95.430

67641
1326295
FT 95.480, FTS 95.430, FTT 95.430

Silencer

67598
1321301

67983
1287304
Excl. F T 95.380, FTG 95.380/430/480, FTR 95.430, FTT 95.430

67917
1342965
FT 95.480, FTS 95.430, FTT 95.430

67982
1312753
Excl. FTR 95.380, FTT 95.430

67954
1347652
FT 95.480, FTR 95.480

67950
1331936
FT 95.380/430/480

67912
1315863
FTG 95.480

67916
1316528
FT 95.480, FTG 95.380

67959
1312801
1320883
FTG 95.430

67918
1316120
FT 95.480, FTT 95.430

Mounting Parts

1.
67428
117280-3
1232979
1452973

2.
67413
1310527

2. FTG 95.380, FTG 95.430, FTG 95.480
67492
1310528

3.
67419
1249187

4.
67414
1248785
1436185

5.
00564

6.
67422
1302930

7.
94464
1290255

Horizontal
LHD
Standard

Series 95 XF

Type

Euro II



FTT 95.530



FAS 95.530

Front pipe

67640
1328596

67673
1334253
1293278

67675
1322830

Silencer

67598
1321301

Tail pipe

67982
1312753

67983
1287304

FTT 95.530

Mounting Parts

1.
67428
117280-3
1232979
1452973

2.
67413
1310527

3.
67419
1249187

4.
67414
1248785
1436185

5.
00958
1296068

Horizontal
LHD
Standard

Series 95 XF

Type

Euro II



FAC 95.380
FAC 95.430



FAD 95.380
FAD 95.430
FAD 95.480



FTC 95.480



FTD 95.480

Front pipe

67662
1292569

67671
1334252
1296778
1428366
FAD, FTC,F TD 95.480

67663
1334251
1293071
1428365
Excl.F AD, FTC,F TD 95.480

67612
1344053
1428367
1629454
FAD, FTC,F TD 95.480

67619
1349555
1428368
FAC 95.380/430
FAD 95.380

Mounting Parts

1.
67428
117280-3
1232979
1452973

2.
67413
1310527

3.
67419
1249187

4.
67414
1248785
1436185

5.
00564T
1296068

6.
10459
1302930

7.
94463
1290255

Silencer

67601
1343277

67602
1334055
Excl.F AC 95.380

67598
1321301

Tail pipe

67982
1312753
Excl.F AC 95.380/430, FAD 95.380/430

67912
1315863
Excl.F AD, FTC,F TD 95.480

67953
1310235
1312651
1617723
Excl.F AC 95.380/430, FAD 95.380
FTD 95.480

Horizontal
LHD
Standard

Series 95 XF

Type

Euro II



FA 95.480



FT 95.480



FAS 95.480



FTS 95.380



FAT 95.380

FAT 95.430

FAT 95.480



FTT 95.480

Front pipe

67671
1334252
1296778
1428366
Excl.F A 95.480, FAT 95.380/430

67663
1334251
1293071
1428365
FAT 95.380/430

67612
1344053
1428367
1629454
Excl.F AT 95.380/430

Silencer

67675
1322830

67506
1296060

Tail pipe

05664
Cut & F it

07157

Mounting Parts

1.
67428
117280-3
1232979
1452973

2.
67495
1296055

3.
67419
1249187

4.
67414
1248785
1436185

5.
00958
1296068

6.
94464
1290255

Vertical
LHD
Standard

Series XF 95

Type

Euro III



FAD 95.430S
FAD 95.480S
FAD 95.530S

Front pipe

67612
1344053
1428367
1629454



66723
1600806
1425334



66722
1600803
1425332
Excl.F AD 95.430

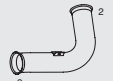

Silencer

67577
1440884

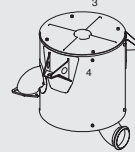

Tail pipe

67992
1457352

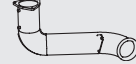

67946
1457351
Excl.F AD 95.430



Mounting Parts

1.
94464
1290255



2.
67428
117280-3
1232979
1452973



3.
67414
1248785
1436185



4.
67430
1452203



Horizontal
LHD/RHD
Standard

Series XF 95

Type

Euro III



FA 95.380S
FA 95.430S
FA 95.480S
FA 95.530S



FAN 95.380S
FAN 95.430S
FAN 95.480S
FAN 95.530S



FAR 95.430S
FAR 95.430X
FAR 95.480S
FAR 95.530S



FAS 95.380S
FAS 95.430S
FAS 95.480S
FAS 95.530S



FAT 95.480S
FAT 95.480X



FT 95.380
FT 95.380X
FT 95.430S
FT 95.430X
FT 95.480S
FT 95.530S

Horizontal
LHD/RHD
Standard

Front pipe

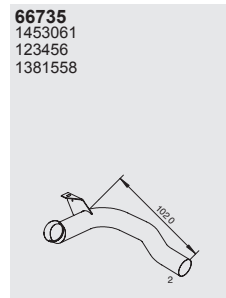
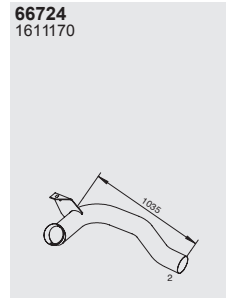
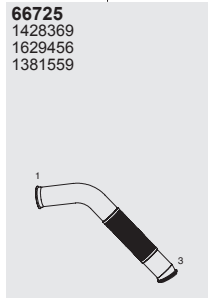

Silencer

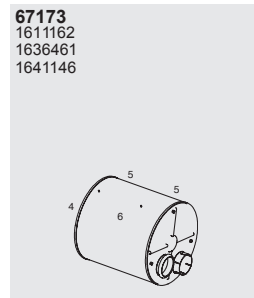
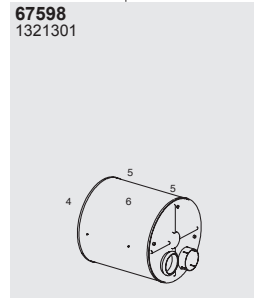

Tail pipe

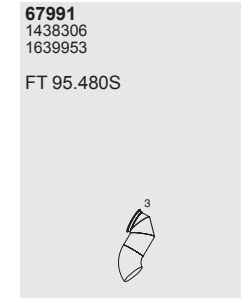
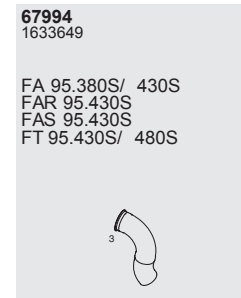
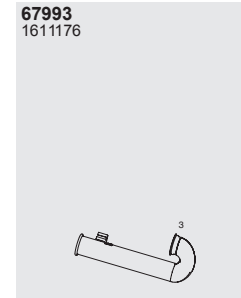
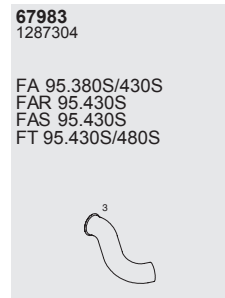
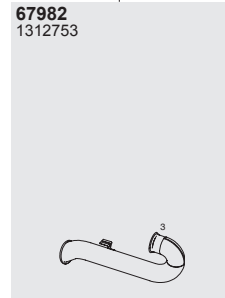

Mounting Parts

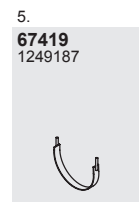
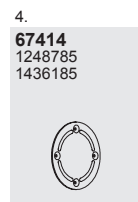
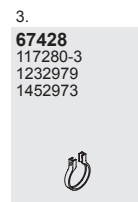
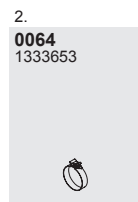
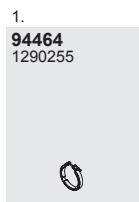

Series XF 95

Type

Euro III



FA 95.380S
FA 95.430S
FA 95.480S
FA 95.530S



FAN 95.380S
FAN 95.430S
FAN 95.480S
FAN 95.530S



FAR 95.430S
FAR 95.430X
FAR 95.480S
FAR 95.530S



FAS 95.380S
FAS 95.430S
FAS 95.480S
FAS 95.530S



FAT 95.480S
FAT 95.480X



FT 95.380
FT 95.380X
FT 95.430S
FT 95.430X
FT 95.480S
FT 95.530S

Horizontal
LHD/RHD
Standard

Front pipe

66725
1428369
1629456
1381559

66724
1611170

66735
1453061
123456
1381558

Silencer

67598
1321301

67173
1611162
1636461
1641146

Tail pipe

67982
1312753

67983
1287304

FA 95.380S/430S
FAR 95.430S
FAS 95.430S
FT 95.430S/480S

67993
1611176

67994
1633649

FA 95.380S/ 430S
FAR 95.430S
FAS 95.430S
FT 95.430S/ 480S

67991
1438306
1639953

FT 95.480S

Mounting Parts

1.
94464
1290255

2.
00064
1333653

3.
67428
117280-3
1232979
1452973

4.
67414
1248785
1436185

5.
67419
1249187

6.
67413
1310527

Series XF 95

Type

Euro III



FA 95.380S
FA 95.380X
FA 95.430S
FA 95.430X
FA 95.480S
FA 95.480X
FA 95.530S



FAN 95.380S
FAN 95.430S
FAN 95.480S
FAN 95.530S
FAR 95.380X
FAR 95.430X
FAR 95.430S
FAR 95.480S
FAR 95.530S
FAS 95.380S
FAS 95.430S
FAS 95.480S
FAS 95.530S



FAT 95.430S
FAT 95.480S
FAT 95.530S

Horizontal
LHD/RHD
Standard

Front pipe

67612
1344053
1428367
1629454

66729
1610673

66720
1453059
1364858
Excl.F AN
Excl.F AR 95.380X

Mounting Parts

1.
94464
1290255

2.
67428
117280-3
1232979
1452973

3A.
00564

3B.
00064
1333653

4.
67414
1248785
1436185

5.
67419
1249187

6.
67413
1310527

Silencer

67173
1611162
1636461
1641146

Tail pipe

67983
1287304
Excl.F A 95.380X/ 430X/ 480X
Excl.F AN 95.530S
Excl.F AR 95.380X

67991
1438306
1639953
FA 95.480S
FAS 95.480S

67950
1331936
Excl.F A 95.430X
Excl.F AN
Excl.F AR 95.380X

67944
1623466
1745025
FA 95.430X
FAN 95.430S
FAR 95.380X/ 430X

67993
1611176
Excl.F A 95.430X
Excl.F AR 95.380X

67940
1611175
FAR 95.430X

67994
1633649
Excl.F A 95.380X/ 430X/ 480X
Excl.F AN
Excl.F AR 95.380X

Series XF 95

Type

Euro III

- FA 95.380S
- FA 95.380X
- FA 95.430S
- FA 95.480S
- FA 95.480X
- FA 95.530S
- FAR 95.430S
- FAR 95.430X
- FAR 95.480S
- FAR 95.530S
- FAS 95.380S
- FAS 95.430S
- FAS 95.480S
- FAS 95.530S
- FAT 95.430S
- FAT 95.480S
- FAT 95.530S

- FT 95.380S
- FT 95.380X
- FT 95.430S
- FT 95.430X
- FT 95.480S
- FT 95.480X
- FT 95.530S
- FT 95.530X

- FTP 95.380S
- FTP 95.480S
- FTR 95.430S
- FTR 95.480S
- FTR 95.530S
- FTS 95.380S
- FTS 95.430S
- FTS 95.480S
- FTS 95.530S

- FTT 95.430S
- FTT 95.460S
- FTT 95.480S
- FTT 95.530S

Horizontal
LHD/RHD
Standard

Front pipe

67612
1344053
1428367
1629454



66729
1610673

Excl. F TP 95.380S

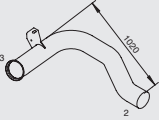

66720
1453059
1364858

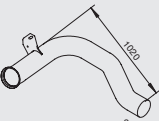

Silencer

67598
1321301

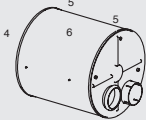

Tail pipe

67983
1287304

FA 95.380S/ 430S/ 480S/ 530S
FAR 95.430X
FT 95.380S/ 430S/ 430X/ 480S/ 530S
FTP 95.480S



67982
1312753

FT 95.380S/ 430S / 480S/ 530S
FTP 95.380S



67950
1331936

Excl. FTP

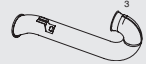

67993
1611176

Excl. FTP

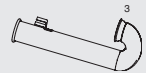

67994
1633649

FA 95.380S/ 430S/ 480S/ 530S
FAR 95.430X
FT 95.380S/ 430S/ 430X/ 480S/ 530S
FTP 95.480S



Mounting Parts

1.
94464
1290255



2.
00064
1333653



3.
67428
117280-3
1232979
1452973



4.
67414
1248785
1436185



5.
67419
1249187



6.
67413
1310527



Series XF 95

Type

Euro III



FTT 95.430S
FTT 95.460S
FTT 95.480S
FTT 95.480X
FTT 95.510T
FTT 95.530S

Front pipe

Silencer

Tail pipe

67612
1344053
1428367
1629454

Excl.F TT. 95.510T



66729
1610673

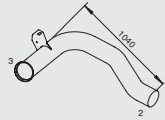

67173
1611162
1636461
1641146

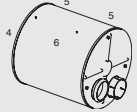

67993
1611176



67950
1331936

Excl.F TT 95.480X/ 510T



67991
1438306
1639953

FTT 95.480S/ 530S



66720
1453059
1364858

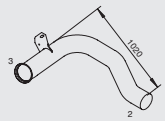

67983
1287304

FTT 95.430S/ 480S/ 530S



67994
1633649

FTT 95.430S/ 480S/ 530S



66734
1643463
1743073

FTT 95.510T



66730
1671106

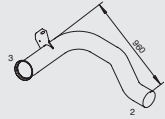

Mounting Parts

1.
94464
1290255



2.
00064
1333653



3.
67428
117280-3
1232979
1452973



4.
67414
1248785
1436185



5.
67419
1249187



6.
67413
1310527



Horizontal
LHD/RHD
Standard

Series XF 95

Type

Euro III



FT 95.380S
 FT 95.380X
 FT 95.430S
 FT 95.430X
 FT 95.480S
 FT 95.480X
 FT 95.530S
 FT 95.530X



FTP 95.380S
 FTP 95.430S
 FTP 95.480S
 FTP 95.530S
 FTR 95.430S
 FTR 95.480S
 FTR 95.530S
 FTS 95.380S
 FTS 95.430S
 FTS 95.480S
 FTS 95.530S

Front pipeT

67612
 1344053
 1428367
 1629454

66729
 1610673

66720
 1453059
 1364858
 Excl.F TP 95.380S/
 430S/ 530S

Silencer

67173
 1611162
 1636461
 1641146

ail pipe

67993
 1611176

67908
 1623596
 FT 95.380S/ 380X/ 430S/ 430X/
 480S/ 530S

67994
 1633649
 Excl.F T 95.380X/ 480X/ 530X
 Excl. 95.380S

67940
 1611175
 FT 95.380S/ 430S/ 430X/ 480S/
 530S

67950
 1331936
 Excl. FTP

67983
 1287304
 Excl.F T 95.380X/ 480X/ 530X
 Excl.F TS 95.380S

67944
 1623466
 1745025
 Excl.F T 95.530X,
 Excl.F TP, FTR
 Excl.F TS 95.380S

67902
 1312753
 FT 95.380S/ 430S/ 480S/ 530S

67991
 1438306
 1639953
 Excl. 95.380S/ 380X/ 480X/ 530X
 Excl.F TP 95.380S
 Excl.F TS 95.380S/ 430S

Mounting Parts

1.
94464
 1290255

2.
67428
 117280-3
 1232979
 1452973

3A.
00564

3B.
00064
 1333653

4.
67414
 1248785
 1436185

5.
67419
 1249187

6.
67413
 1310527

Horizontal
 LHD/RHD
 Standard

Series XF 95

Type

Euro III



FAN

Front pipe

66725
1428369
1629456
1381559

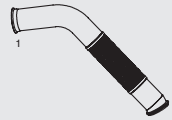

66738
1608838



Silencer

67564
1678263
1608809
1608757

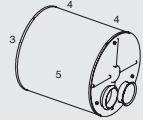

Tail pipe

67999
1619431
1365875

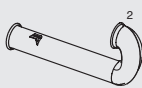

Mounting Parts

1.
94464
1290255



2.
67428
117280-3
1232979
1452973



3.
67414
1248785
1436185



4.
67419
1249187



5.
67496
1325072



Horizontal
LHD/RHD
Standard

Series XF 95

Type

Euro III



FTT 95.480X

Front pipe

67662
1292569



67671
1334252
1296778
1428366



67675
1322830

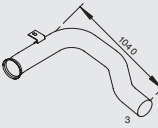

Silencer

67598
1321301

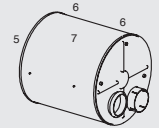

Tail pipe

67983
1287304



67612
1344053
1428367
1629454



Mounting Parts

1.
94464
1290255



2.
67422
1302930



3.
00564



4.
67428
117280-3
1232979
1452973



5.
67414
1248785
1436185



6.
67419
1249187



7.
67413
1310527



Horizontal
LHD/RHD
Standard

Series XF 95

Type

Euro III



FAK 95.380S
FAK 95.430S
FAK 95.480S
FAK 95.530S



FAR 95.480X



FTG 95.380S
FTG 95.430S
FTG 95.480S
FTG 95.530S



FTM 95.430S
FTM 95.480S
FTM 95.530S

Front pipe

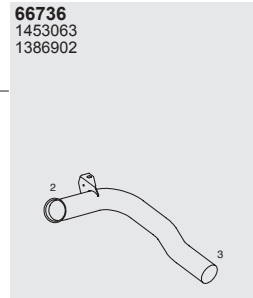
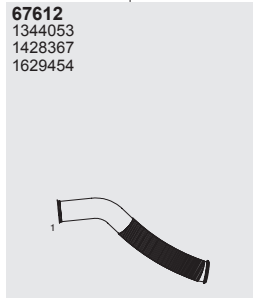

Silencer

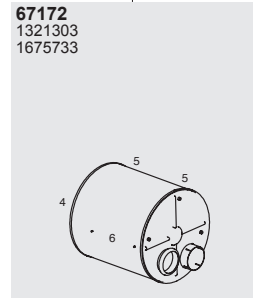

Tail pipe

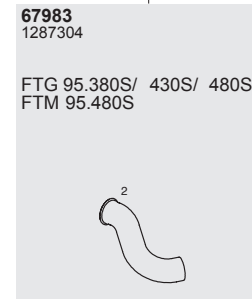
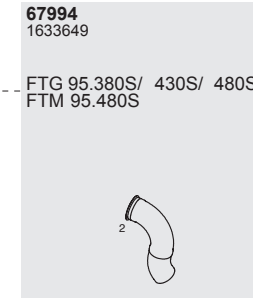
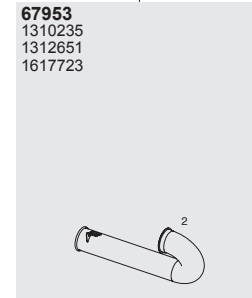

Mounting Parts

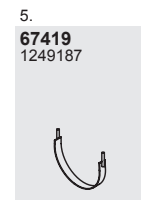
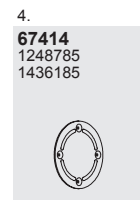
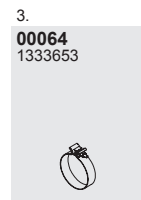
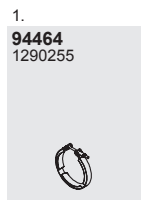

Horizontal
LHD/RHD
Standard

Series XF 95

Type

Euro III

FA 95.430S

FAN 95.380S
FAN 95.480S

FAT 95.380S
FAT 95.430S
FAT 95.480S
FAT 95.530S

FT 95.380S
FT 95.430S
FT 95.480S
FT 95.530S

FTG 95.430S
FTG 95.530S

FTM 95.530

FTP 95.480S

FTR 95.430S
FTR 95.530S

FTS 95.530S

FTT 95.430S
FTT 95.480S

Front pipe

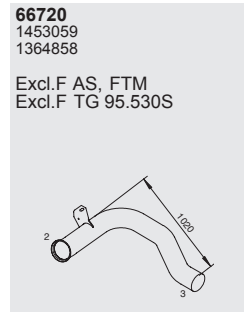
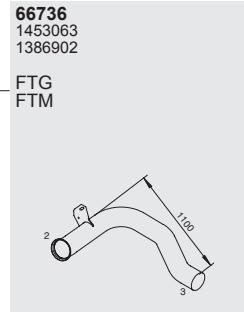
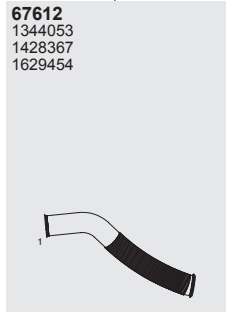

Silencer

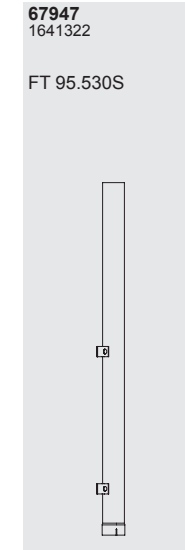
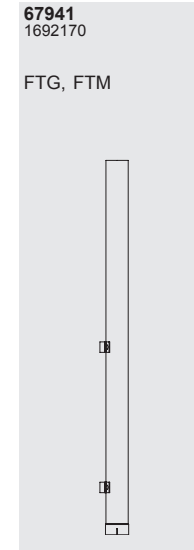
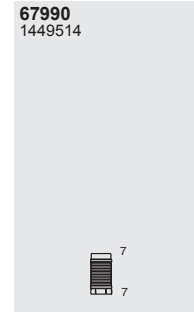
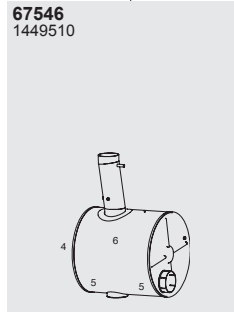

Tail pipe

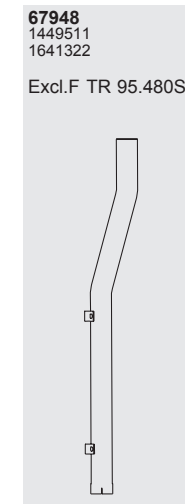
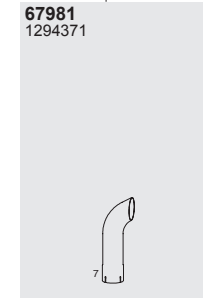

Mounting Parts

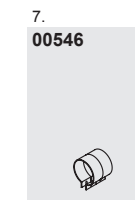
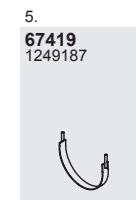
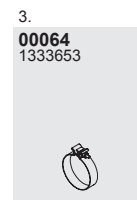
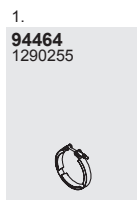

Vertical
LHD/RHD
Standard

Series XF 95

Type

Euro III



FA 95.430S



FAN 95.530S

Front pipe

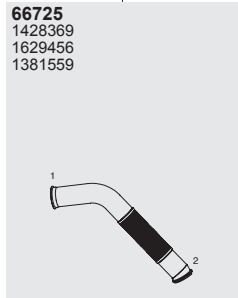

Silencer

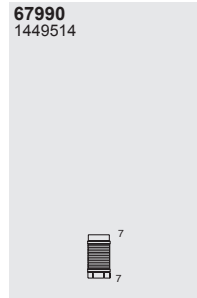
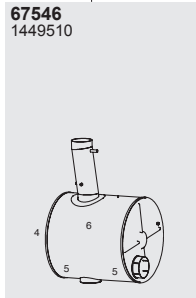

Tail pipe

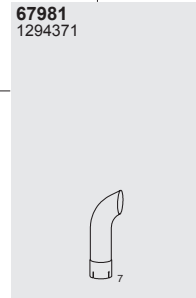
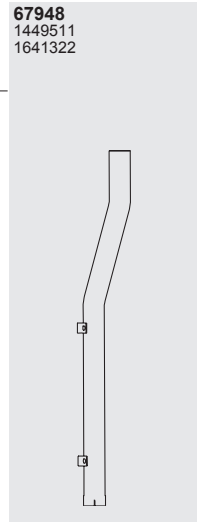

Mounting Parts

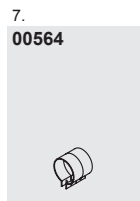
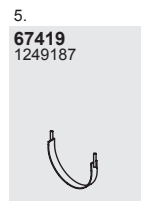
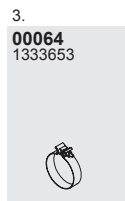
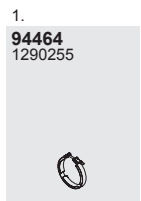

Vertical
LHD/RHD
Standard

Series XF 95

Type

Euro III



FTP 95.380S
FTP 95.430S



FTT 95.560T

Front pipe

66795
1379456

Excl.F TT 95.560T



66796
1379437

Excl.F TT 95.560T

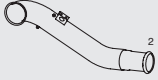

66798
1636866

FTT 95.560T



66797
1638131

FTT 95.560T

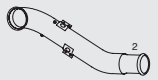

Silencer

67530
1294370



Tail pipe

67981
1294371



Mounting Parts

1.
67428
117280-3
1232979
1452973



2.
67467
1232412



3.
67458
1255360



4.
00564



5.
67456
1274960



Vertical
LHD/RHD
Standard

SOYLU / EURO I, II, III

IVECO

<u>Daily City Truck</u>	<u>79</u>	<u>Eurostar Cursor</u>	<u>118</u>
<u>Eurocargo</u>	<u>81</u>	<u>Eurotech</u>	<u>121</u>
<u>Eurocargo Tector</u>	<u>93</u>	<u>Eurotech Cursor</u>	<u>124</u>
<u>Eurotrakker</u>	<u>95</u>	<u>Eurotech / Eurostar</u>	<u>133</u>
<u>Eurotrakker Cursor</u>	<u>99</u>	<u>Stralis</u>	<u>136</u>
<u>Eurostar</u>	<u>117</u>		

Series DAILY CITY TRUCK

Type

Euro II



29L10
29L12
35S9
35S10
35S11
35S12
35S13
35S15
35C9
35C10
35C11
35C12
35C13
35C15
50C11
50C13
50C15
65C13
65C15



40C13
40C15
50C11
50C13
50C15

Page 1/2
Next page:
(syst. 128100094)

Horizontal
LHD
Standard

Front pipe

60659
500329487
504033946

29L10, 29L12
35C9, 35C10, 35C11, 35C12, 35C13, 35C15
35S9, 35S10, 35S11, 35S12, 35S13, 35S15
50C11, 50C13, 50C15
65C13, 65C15

60650
500329481
504033945
504098008

35C11, 35S11
50C11

35C13, 35S11, 35S13
50C11
Cat.

64184
500329489
500329483

60654
500329488

, WB 3000/3450/3750
35S9
WB 3000/3450/3750/4100
35C9

, WB 3000/3300/3950
35C9, 35S9
Cat.

Mounting Parts

1.
60428
500329485

2.
64478
8585923

Series DAILY CITY TRUCK

Type

Euro II



29L10
29L12
35S9
35S10
35S11
35S12
35S13
35S15
35C9
35C10
35C11
35C12
35C13
35C15
50C11
50C13
50C15
65C13
65C15



40C13
40C15
50C11
50C13
50C15

Page 2/2
Previous page:
(syst. 128100092)

Horizontal
LHD
Standard

Silencer

Tail pipe

64184
500329489
500329483

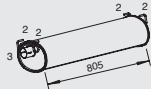

64946
500347394

All WB -S ide outlet

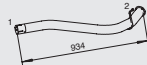

64994
500347398

, WB 3750 -S ide outlet
35C11
50C11, 50C13

64990
504048965

, WB 3300
29L10
35S10, 35S11, 35S12, 35S13, 35S15

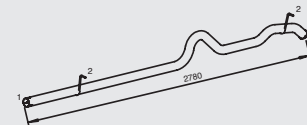

64945
500314665

All WB

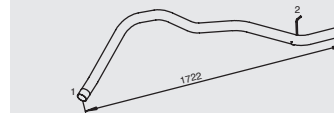

Mounting Parts

1.
64477
8582510



64991
500345624

, WB 3750
35C11
50C11, 50C13

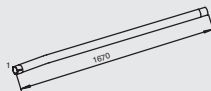

64992
500345625

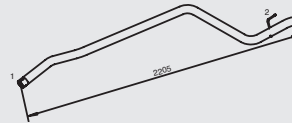

64947
504063148

, WB 3300
35S10, 35S11, 35S12, 35S13
 , WB 3000
29L12
35S12



2.
60482
500329485



64993
500345628

, WB 3950
35C11, 35C13, 35C15
50C11, 50C13, 50C15
 , WB 3950
40C13, 40C15
50C11, 50C13, 50C15

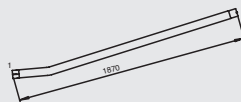

64999
504035521



64948
504035520

, WB 3300
35C11, 35C12, 35C13
50C15
 , WB 3300
40C13, 40C15

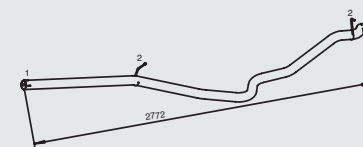

Series EUROARGO

Type

Euro II/III



- 60 E10
- 60 E12
- 60 E14
- 65 E10
- 65 E12
- 65 E12H
- 65 E14
- 75 E12
- 75 E14
- 75 E15

Front pipe

64748
500340797
98460406



64616
98434899
98434902



Silencer

64558
98429580

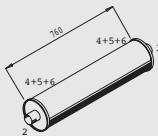

Tail pipe

64321
98435273

WB 2700

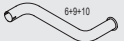

64395
98447603
98427453

2135993 ▶CHno
Incl.A ustria



64393
8589651

▶CHno 2135992
2127503 ▶CHno



60716
99447848

2135993 ▶CHno
Austria, 75 E15

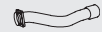

64508
98440310
98440301
99431097

Only for A ustria



64910
98445569

Option 778-781, body 2500x500,
2500x500x1400

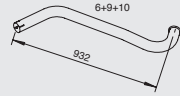

64913
99460964

65 E12, 65 E14, 75 E12, 75 E14
WB >2700
Left ailp ipe

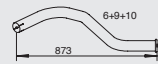

60715
500329362
99460967

2187843 ▶CHno

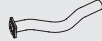

64170
99456851

65 E12, 65 E14, 75 E12, 75 E14

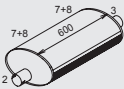

64322
98435272

WB 3105, 3690, 4185

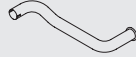

64919
500371518

65 E12, 65 E14, 75 E12, 75 E14
WB 2700



Mounting Parts

1.
64480
8125582



2.
64448
8567698
8581642



3.
64447
8591167



4.
64484
98435271



5.
64451
98435270



6.
64087
93818454
93809649
93806171



7.
64472
98447608



8.
64459
98415197



9.
64430
98435278



10.

Horizontal
LHD
Standard

Series EURO CARGO

Type

Euro II/III



75 E15
80 E15
80 E18
100E 15
100E 18

Front pipe

64680
99481953
98419097
98419003

64697

64698
Alternative

64630
Alternative

Silencer

64615
98468624
98491297

64557
4837896

18580
Cat.

Tail pipe

64395
98447603
98427453

64307
99462480
98488530
80 E18, 100E 18

06892

Mounting Parts

1. **34481**
8540133

2. **28012**
61597491
8572665
61597791

3. **64477**
98447608

4. **64087**
93818454
93809649
93806171

5. **27412**
99479771
98497798
98497795

6. **00992**

7. **64454**
98423680
98499870

8. **00699**

9. **28012**
61597491
8572665
61597791

10. **04610**

11. **60485**
98497790

Horizontal
LHD
Standard

Series EUROARGO

Type

Euro II/III



80 E15
80 E18
85 E15H

(excl. WB 2700)

Front pipe

64680
99481953
98419097
98419003
Excl. 8 5E 18 H
Excl. 85E15H, WB 3690,4185,4815

64602
500369621

85 E18H

64601
500369619

80 E15H

64697

Alternative

64698

Alternative

64630

Alternative

60717

Alternative

Silencer

64611
98454705
500372947

2310284 ▶CHno

64606
500369625
99463271

2310284 ▶CHno

64605
500372948
99463724

2310284 ▶CHno
WB 3300, 3105

64557
4837896

64508
98440310
98440301
99431097

Tail pipe

64395
98447603
98427453

64349
99462479
98448344
98421172
WB >3105

64307
99462480
98488530

WB 3105

Mounting Parts

1. x2
34481
8540133

2.
00948
4790368
4790369
4715199

3.
28012
61597491
8572665
61597791

4A.
64087
93818454
93809649
93806171

4B.
64459
98415197

5.
64454
98423680
98499870

6.
64473
98428398

7.
64483
99463466
98420236

8.
27412
99479771
98497798
98497795

9.
00699

Horizontal
LHD
Standard

Series **EUROCARGO**

Type

Euro II/III



75 E15

Front pipe

64680
99481953
98419097
98419003

64697
Alternative

64698
Alternative

60717
Alternative

64630
Alternative

64672
98464158

60712
500372950
2310284 ▶CHno

Silencer

64557
4837896

64167
99461871
2188886 ▶CHno

Tail pipe

64395
98447603
98427453

64914
99464940

64690
98499871

Mounting Parts

1.
34481
8540133

2.
28012
61597491
8572665
61597791

3.
00948
4790368
4790369
4715199

4A.
64087
93818454
93809649
93806171

4B.
64459
98415197

5.
27412
99479771
98497798
98497795

6.
64454
98423680
98499870

7.
00699

8.
60485
98497790

9.
64483
99463466
98420236

Horizontal
LHD
Standard

Series EUROARGO

Type

Euro II/III



- 120E 15
- 120E 15H
- 120E 18
- 120E 18H
- 130E 15
- 130E 18
- 150E 15
- 150E 15H
- 150E 18
- 150E 18H
- 150E 21H
- 170E 15
- 170E 18

Incl.A uustria

- 120E 23
- 130E 23
- 150E 23
- 280E 23

Horizontal
LHD
Standard

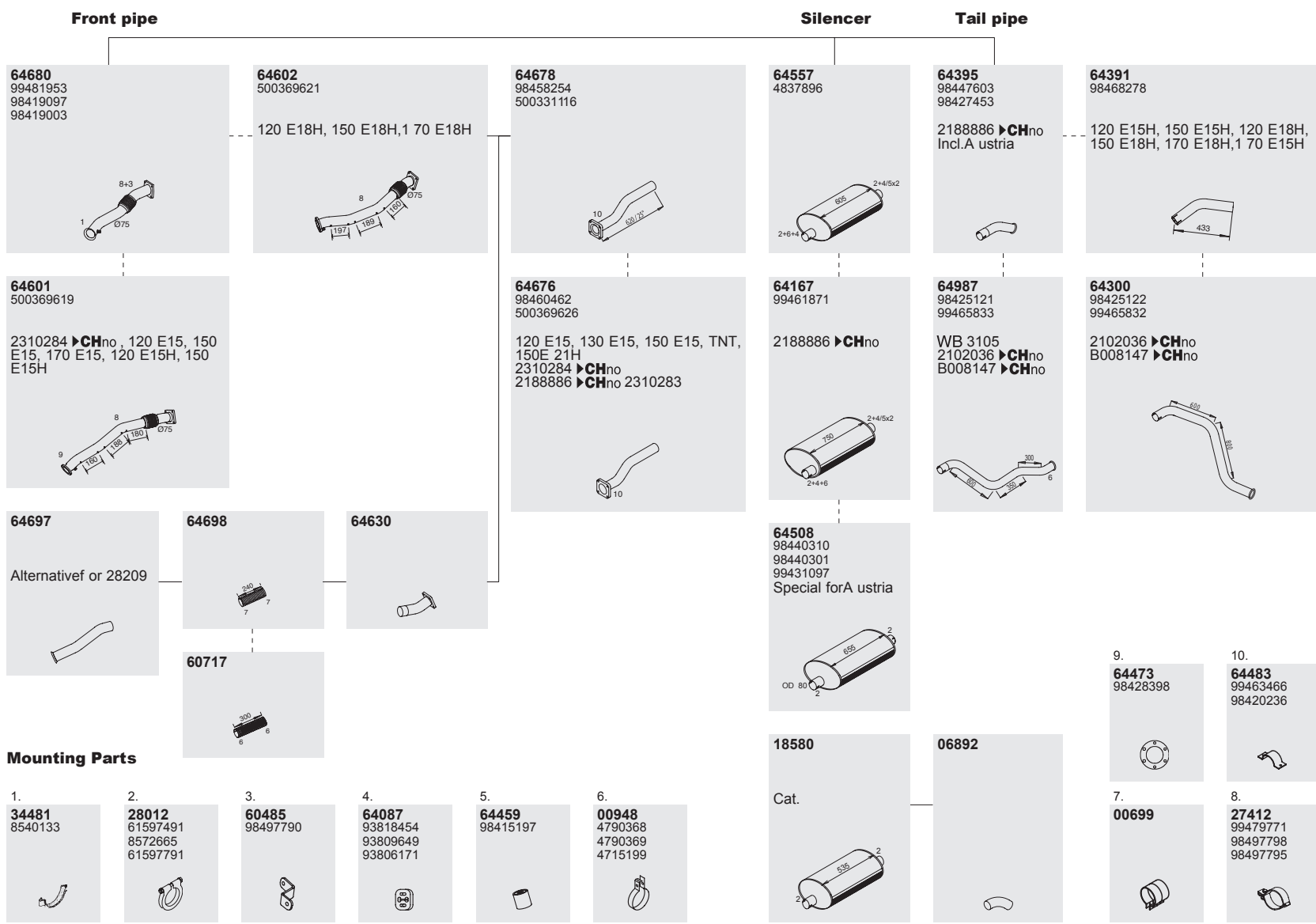

Series EURO CARGO

Type

Euro II/III



- 120E 23
- 130E 23
- 150E 23
- 170E 23
- 260E 23
- 260E 23KE
- 280E 23

Front pipe

64677
98460460
500307078

64676
98460462
500369626

2310284 ▶CHno

60719
500370057

60713
98460464

280E 23
WB 3465

Silencer

64517
4838828

18580

Cat.

64392
98426470

2127503 ▶CHno
B017239 ▶CHno
Incl. Austria

64985
98488102
98488331

▶CHno 2102036
WB 3105

Tail pipe

64882
98488103
98426467
98467197

▶CHno 2102036
▶CHno 2127502
▶CHno B017238
▶CHno B016503
Incl. Austria

06892

Mounting Parts

1. x2
34481
8540133

2.
28012
61597491
8572665
61597791

3.
28069
4819971

4.
64087
93818454
93809649
93806171

5.
64459
98415197

6.
00948
4790368
4790369
4715199

7.
64454
98423680
98499870

8.
27412
99479771
98497798
98497795

9.
64483
99463466
98420236

04610

Horizontal
LHD
Standard

Series EUROARGO

Type

Euro II/III



95 E15
95 E21
135E 18
135E 23

Front pipe

Silencer

64674
98453453

95 E21
135E 23

OD 73

60714
99480896

95 E21, truck
S6 36/2-5\&36

64628
98488064

64501
99432346

S6 36/2-5\&36+ ZFS6/36-2
95 E21

64627
98488061

95 E15
135E 18
95 E21

60728
99480899

S6 36/2-5\&36+ ZFS6/36-2
95 E21

60710
99480892

135E 23 truck
ZFS6/36-2

Mounting Parts

1.
28012
61597491
8572665
61597791

2.
64470
98489665

Horizontal
LHD
Standard

Series EURO CARGO

Type

Euro II/III



100E 15
100E 18

Front pipe

64680
99481953
98419097
98419003



64601
500369619

100E 15
2310284 ▶CHno

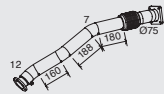

64611
98454705
500372947



64697



64698



64630



64606
500369625
99463271

100E 15
2310284 ▶CHno



60717



Mounting Parts

1. x2 ▶CHno 2310283

34481
8540133



2. **64483**
99463466
98420236



3. **28012**
61597491
8572665
61597791



4. **64087**
93818454
93809649
93806171



5. **64459**
98415197



Silencer

64557
4837896

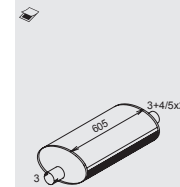

64167
99461871

2188886 ▶CHno

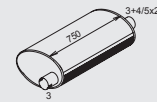

18580

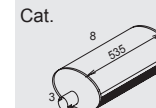

64207
99462480
98488530

WB 2700, 3105, 3330



64395
98447603
98427453

2188886 ▶CHno
Incl. A uustria



06892



6. 2031179 ▶CHno, WB 3105

64434
98448342



6. 2031179 ▶CHno, WB >3015

64468
98421182
8599355



64349
99462479
98448344
98421172

WB >3105
▶CHno 2127502



11. **00699**



12. **64473**
98428398



9. **00948**
4790368
4790369
4715199



10. **60485**
98497790



7. **27412**
99479771
98497798
98497795



8. **04610**



Horizontal
LHD
Standard

Series EUROARGO

Type

Euro II/III



80 E21
100E 21
180E 21

120E L21
WB 3690

Front pipe

64680
99481953
98419097
98419003



64602
500369621

180 E21, 80 E21, 100E 21

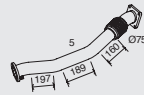

64611
98454705
500372947

80 E21, 100 E21, 180E 21



64697

Alternative



64698

Alternative



64630

Alternative



64606
500369625
99463271

80 E21, 120 EL21, 180 E21,
2310284 ►CHno



60717

Alternative



64605
500372948
99463724

80 E21, 100 E21: WB 3300



Mounting Parts

1. x2 ►CHno 2310283

34481
8540133



2. **00948**
4790368
4790369
4715199



3. **28012**
61597491
8572665
61597791



4. **60485**
98497790



5. **27412**
99479771
98497798
98497795



6. **00699**



7. **64483**
99463466
98420236



8. **64087**
93818454
93809649
93806171



9. **64459**
98415197



10. **64472**
98447608



11. ►CHno 2031178

64454
98423680
98499870



Silencer

64656
98426343

80 E21, 100 E21, 180E 21

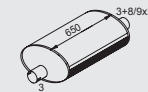

64167
99461871

2188886 ►CHno

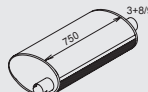

64508
98440310
98440301
99431097

Austria
80 E21, 100E 21

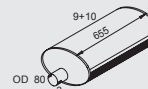

11. 2031179 ►CHno, WB 3105

64434
98448342



Tail pipe

64307
99462480
98488530

80 E21, 100 E21, 180E 21



64349
99462479
98448344
98421172

80 E21, 100E 21

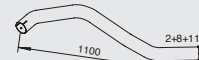

64395
98447603
98427453

80 E21, 100 E21, 120 EL21, 180 E21



11. 2031179 ►CHno, WB >3105

64468
98421182
8599355



Horizontal
LHD
Standard

Series **EUROCARGO**

Type

Euro II/III



150E 27
170E 27

Front pipe

64675
500322473
98463576

64691
Alternatif or 28213

64695

64696

64671
98467198
99474024
500372952
2310284 ▶CHno

Silencer

64517
4838828

64167
99461871

2188886 ▶CHno

Tail pipe

64982
98488103
98426467
98467197
▶CHno 2127502
▶CHno B017238

64392
98426470

2127503 ▶CHno
B017239 ▶CHno

64395
98447603
98427453

2188886 ▶CHno

Mounting Parts

1.
00699

2.
27412
99479771
98497798
98497795

3.
28012
61597491
8572665
61597791

4.
64489
98456735

5.
64468
98421182
8599355

6.
28069
4819971

7.
00940

8.
64087
93818454
93809649
93806171

9.
64459
98415197

10.
64483
99463466
98420236

Horizontal
LHD
Standard

Series EURO CARGO

Type

Euro II/III



320E 27

Front pipe

64675
500322473
98463576

60727
99474027
500395131

E2 engine

64691

Alternative or 28213

64695

64696

64671
98467198
99474024
500372952
WB 3105

64624
98467200
500372958
WB 3465

Silencer

64517
4838828

64502
98452139

64167
99461871

2188886 ▶CHno

Tail pipe

64985
98488102
98488331

▶CHno 2102036, B008147

64971
98467437

64395
98447603
98427453

2188886 ▶CHno

64392
98426470

WB 3465

Mounting Parts

1.
64489
98456735

2.
27412
99479771
98497798
98497795

3.
28012
61597491
8572665
61597791

4.
64483
99463466
98420236

5.
00699

6.
28069
4819971

7.
00940

8.
64087
93818454
93809649
93806171

9.
64459
98415197

Horizontal
LHD
Standard

Series EUROCARGO

Type

Euro II/III

 WB 2700

75 E15
80 E15
100E 15

 **8060.45R**
5.9l tr.
6 cyl.
105K W/143H P

80 E18
100E 18

 **8060.45B**
5.9l tr.
6 cyl.
130K W/170H P

Front pipe

Silencer

64601
500369619

75E15,80E15,100E15:
2310284 ▶CHno

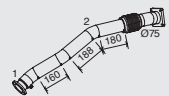

60711
500372942
500372944



64168
99470331

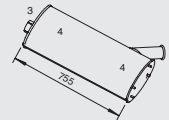

64602
500369621

80E18,100E18:
2310284 ▶CHno

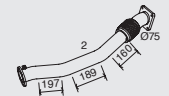

N.A.

500318118

Mounting Parts

1.
64473
98428398



2.
27412
99479771
98497798
98497795



3.
28012
61597491
8572665
61597791



4. x2
60072
98447608



Horizontal
LHD
Standard

Series EUROCARGO TECTOR

Type

Euro III

- 75E13
- 75E15
- 75E15 Eurofire
- 75E15 Restyle
- 75E17
- 75E17 Restyle
- 75E18
- 75E18 Restyle
- 100E17
- 100E17 Restyle
- 100E18
- 100E18 Restyle
- 100E21
- 100E21 Eurofire
- 100E21 Restyle
- 120E17
- 120E17 Restyle
- 120E21
- 120E21 Restyle
- 130E18
- 130E18 Restyle
- 130E21 Restyle
- 130E24
- 130E24 Restyle
- 130E28
- 130E28 Restyle
- 150E18
- 150E21 Restyle
- 150E24
- 150E24 Restyle
- 150E28
- 150E28 Restyle
- 180E21
- 180E21 Restyle
- 180E24
- 180E24 Restyle
- 180E28
- 180E28 Restyle
- 100E17
- 100E18
- 100E21
- 100E18
- 100E21
- 130E18
- 130E24
- 140E24 Eurofire
- 140E28 Eurofire

Horizontal
LHD
Standard

Front pipe

Silencer

Tail pipe

60618
500388499

Excl.
75E series, 100E series, 120E series
100E series, 140E series

64119
500370649

Excl., 75E13, 75E15, 75E15 Eurofire, 75E15 Restyle, 75E17
75E17 Restyle.
100E17, 100E17 Restyle.
120E17, 120E17 Restyle.
100E17

64925
500362808

All types

60791
500362814

75E13, 75E15, 75E15 Eurofire, 75E15 Restyl., 75E17, 75E17 Restyl.
100E17, 100E17 Restyl.
120E17, 120E17 Restyl.
100E17

64163
500370650

75E13, 75E15, 75E15 Eurofire, 75E15 Restyl., 75E17, 75E17 Restyl.
100E17, 100E17 Restyl.
120E17, 120E17 Restyl.
100E17

64941
500371828

75E13, 75E15
100E17, 100E18, 100E21

60617
500362815

75E18
100E18, 100E18 Restyl.
100E21, 100E21
120E21, 120E21 Restyl.
100E18, 100E21



Mounting Parts

- | | | | | |
|--|--|--|---|--|
| <p>1.
67466
500362822
500362805</p> | <p>2.
64425
4839513</p> | <p>3.
64441
500362803</p> | <p>4.
64087
93818454
93809649
93806171</p> | <p>5.
04948
4790368
4790369</p> |
|--|--|--|---|--|

Series EURO CARGO TECTOR

Type

Euro III

-  75E13
- 75E15
- 75E15 Eurofire
- 75E15 Restyle
- 75E17
- 75E17 Restyle
- 75E18
- 75E18 Restyle
- 100E17
- 100E17 Restyle
- 100E18
- 100E18 Restyle
- 100E21
- 100E21 Eurofire
- 100E21 Restyle
- 120E17
- 120E17 Restyle
- 120E21
- 120E21 Restyle
- 130E18
- 130E18 Restyle
- 130E21 Restyle
- 130E24
- 130E24 Restyle
- 130E28
- 130E28 Restyle
- 150E18
- 150E21 Restyle
- 150E24
- 150E24 Restyle
- 150E28
- 150E28 Restyle
- 180E21
- 180E21 Restyle
- 180E24
- 180E24 Restyle
- 180E28
- 180E28 Restyle
-  100E17
- 100E18
- 100E21
- 130E18
- 130E24
- 140E24 Eurofire
- 140E28 Eurofire

Horizontal
LHD
Standard

Front pipe

60617
500362815

75E18
100E18, 100E18 Restyl.
100E21, 100E21
120E21, 120E21 Restyl.

 100E18, 100E21

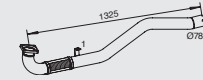

60791
500362814

75E13, 75E15, 75E15 Eurofire, 75E15 Restyl., 75E17, 75E17 Restyl.
100E17, 100E17 Restyl.
120E17, 120E17 Restyl.

 100E17

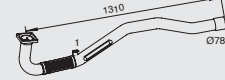

60618
500388499

Excl.
75E series, 100E series, 120E series

 100E series, 140E series

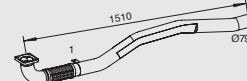

Silencer

64163
500370650

75E13, 75E15, 75E15 Eurofire, 75E15 Restyl., 75E17, 75E17 Restyl.
100E17, 100E17 Restyl.
120E17, 120E17 Restyl.

 100E17

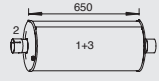

64119
500370649

Excl., 75E13, 75E15, 75E15 Eurofire, 75E15 Restyle, 75E17, 75E17 Restyle.
100E17, 100E17 Restyle.
120E17, 120E17 Restyle.

 100E17

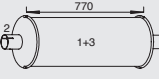

Tail pipe

64925
500362808

All types



64941
500371828

75E13, 75E15
100E17, 100E18, 100E21

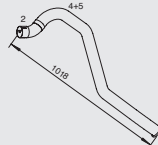

Mounting Parts

1.
67466
500362822
500362805



2.
64425
4839513



3.
64441
500362803



4.
64087
93818454
93809649
93806171



5.
04948
4790368
4790369



Series EUROTRAKKER

Type

Euro II



④X②

Allw heeld rive
190E 34

⑥X④

Allw heeld rive
260E 34
330E 34
380E 34
400E 34

Horizontal
LHD
Standard

Front pipe

64685
8137150
8162322
41011873



64613
8137234



64647
41025012



Silencer

64189
8188965
41020590

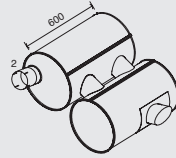

Mounting Parts

1.
64495
42075778
42090023
42081440



2.
64432
42075779
42090154



Series EUROTRAKKER

Type

Euro II



4X2

Allw heeld rive
190E 31
190E 37
190E 42

6X4

Allw heeld rive
260E 37
330E 37
380E 31
380E 37
380E 42



6X6



6X4

400E 31
400E 37
400E 42
440E 37
720E 31
720E 37
720E 42

Horizontal
LHD
Standard

Front pipe

64683
41009549
8132862
8165720



64685
8137150
8162322
41011873



64684
8137110



64612
8137236

Alternative/special pipe



Silencer

64189
8188965
41020590

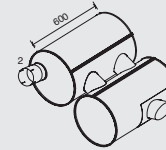

Mounting Parts

1.
64495
42075778
42090023
42081440



2.
64432
42075779
42090154



3.
64485
42075987



Series EUROTRAKKER

System No.: 128101006

Type

Euro II



4X2

Allw heeld rive
190E 31
190E 37
190E 42

6X4

Allw heeld rive
260E 37
330E 37
380E 31
380E 37
380E 42



6X6



6X4

400E 31
400E 37
400E 42
440E 37
720E 31
720E 37
720E 42

Vertical
LHD
Standard

Front pipe

64683
41009549
8132862
8165720



64685
8137150
8162322
41011873



64684
8137110



64612
8137236

Alternative/special pipe



Silencer

64505
8188862

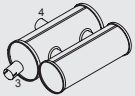

64305
41011644

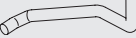

Tail pipe

64301
41011634



64416
41016657



Mounting Parts

1.
64485
42075987



2.
64495
42075778
42090023
42081440



3.
64432
42075779
42090154



4.
64492
42092219



5.
64417
41016647



6.
04169
97163045
97163045
97163045



Series EUROTRAKKER

Type

Euro II



⑧X④

340E 34
340E 37
410E 37
410E 42

Vertical
LHD
Standard

Front pipe

64631
41016214



64636
41015815



64685
8137150
8162322
41011873



64637
41015737



Silencer

64503
41011940



64413
41015893



Tail pipe

64972
41015819



Mounting Parts

1.
64487
4772331



2.
64495
42075778
42090023
42081440



3.
64432
42075779
42090154



4.
64411
41015925
42092142



5.
64492
42092219



6.
11478



7.
04169
97163045
97163045
97163045



Series EUROTRAKKER CURSOR

Type

Euro III



WB 3500
400E 35



WB 3200, 3500,
3800, 4200
260E 31
260E 35
380E 35

WB 3800
180E 27

WB 3800, 4200
190E 27
190E 31
190E 35

WB 4500
180E 24
190E 27
190E 35
260E 31

WB 4800
190E 31
260E 31
260E 35
260E 35 (Hydr.
retarder)

WB 5100
190E 24
190E 27
190E 31
190E 35
260E 35

Horizontal
LHD
Standard

Front pipe

Silencer

60631
41214742

WB 3500:2 60 E35.
 WB 3800:1 80 E27, 190E 31,1 90 E35, 260E 35.
WB 4200:1 90 E31, 190E 35.
WB 4500:1 80 E24, 190E 35

64189
8188965
41020590

60632
41214747

WB 3500:4 00 E35.
 WB 3200, 3500:2 60 E31, 260E 35,3 80 E35.
WB 3800, 4200:1 90 E27, 190E 31,1 90 E35, 260E 31,2 60 E35, 380E 35.
WB 4500:1 90 E27, 190E 35,2 60 E31.

Mounting Parts

1.
60483
41201881

2.
64432
42075779
42090154

3.
60484
41012236

4.
60480
41012232

Series EUROTRAKKER CURSOR

Type

Euro III

►CHno4236341
►CHnoC086488

 WB 3800
400E 35

 WB 3200
260E 31
260E 35

WB 3500
260E 31
380E 35

WB 3800
190E 24
190E 31
190E 35
260E 31
260E 35
380E 35

WB 4200
180E 24
190E 24
190E 35
260E 31
380E 35

WB 4500
180E 24
190E 24
190E 31
190E 35
260E 31
260E 35

WB 4800
260E 31
260E 35

WB 5100
190E 35

Horizontal
LHD
Standard

Front pipe

64287
500301947



64284
41201287

Excl.  WB 3800:3 80 E35,
WB 4200:1 80 E24, 190E 35,
WB 4500:1 80 E24

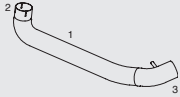

64289
41210296

►CHno 4236341
►CHno C086488

 WB 3800:1 90 E31, 260E 31, 260E 35, 380E 35.
WB 4200:1 80 E24, 190E 35.
WB 4500:1 80 E24, 190E 31, 190E 35



60639
41214836

4236342 ►CHno
C086489 ►CHno

 WB 3800:1 90 E31, 260E 31, 260E 35, 380E 35.
WB 4200:1 80 E24, 190E 35.
WB 4500:1 80 E24, 190E 31, 190E 35

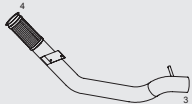

60637
41214804

4236342 ►CHno
C086489 ►CHno

Excl.  WB 3800:3 80 E35,
WB 4200:1 80 E24, 190E 35,
WB 4500:1 80 E24.



Silencer

64189
8188965
41020590

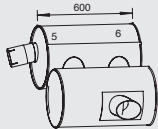

Mounting Parts

1.
64492
42092219



2.
64495
42075778
42090023
42081440



3.
64432
42075779
42090154



4.
60483
41201881



5.
60484
41012236



6.
60480
41012232



Series EUROTRAKKER CURSOR

Type

Euro III



WB 3200
440E 38 (Hydr. retarder)
440E 44
720E 38
720E 44
720E 44 (Hydr. retarder)
720E 48

WB 3500
400E 38
400E 44
720E 38

WB 3800
400E 38
400E 44
400E 44 (Hydr. retarder)

WB 4800
720E 44

Front pipe

Silencer

60631
41214742

WB 3500:7 20 E38
WB 3800:4 00 E38, 400E 44
WB 4800:7 20 E44

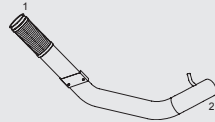

64136
41213998

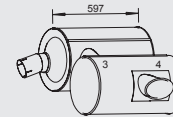

60632
41214747

WB 3200:4 40 E38(Hydr.r etarder), 440E 44,7 20 E44, 720E 44 (Hydr.retarder), 720E 48
WB 3500:4 00 E38, 400E 44
WB 3800:4 00 E38, 400E 44,4 00 E44(Hydr.r etarder)

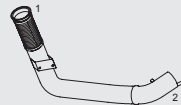

Mounting Parts

1.
60483
41201881



2.
64432
42075779
42090154



3.
60484
41012236



4.
60480
41012232



Horizontal
LHD
Standard

Series EUROTRAKKER CURSOR

Type

Euro III



- WB 3200
- 260E 38
- 260E 44
- WB 3500
- 260E 38
- 260E 44
- 260E 48
- WB 3800
- 190E 38
- 190E 44
- 190E 44 (Hydr. retarder)
- WB 3820
- 260E 38
- 260E 44
- 260E 44 (Hydr. retarder)
- 260E 48 (Hydr. retarder)
- WB 4200
- 190E 38
- 190E 44
- 260E 38
- 260E 44
- 260E 48
- WB 4500
- 190E 38
- 190E 38 (Hydr. retarder)
- 190E 44 (Hydr. retarder)
- 190E 44 (Hydr. retarder)
- 260E 38
- 260E 38 (Hydr. retarder)
- 260E 44 (Hydr. retarder)
- 260E 48
- WB 4800
- 260E 38
- 260E 44
- 260E 48

Horizontal
LHD
Standard

Front pipe

Silencer

60631
41214742

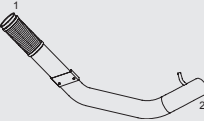

WB 3500: 260E 38
WB 3800: 190E 38, 1 90 E44
WB 3820: 260E 38, 2 60 E44
WB 4200: 190E 38, 1 90 E44
WB 4500: 190E 38, 1 90 E44
WB 4800: 260E 44

64136
41213998

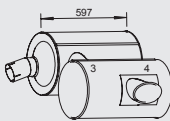

60632
41214747

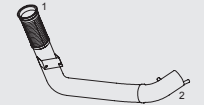

Mounting Parts

1.
60483
41201881



2.
64432
42075779
42090154



3.
60484
41012236



4.
60480
41012232



Series EUROTRAKKER CURSOR

Type

Euro III



WB 3200
380E 38
380E 44
380E 48
380E 48 (Hydr. retarder)

WB 3500
380E 38
380E 44
380E 48

WB 3800
380E 38
380E 44

WB 3820
380E 38
380E 44
380E 48 (Hydr. retarder)

WB 4200
380E 38
380E 44
380E 44 (Hydr. retarder)
380E 48
380E 48 (Hydr. retarder)

WB 4500
380E 44

WB 4800
380E 48

Horizontal
LHD
Standard

Front pipe

Silencer

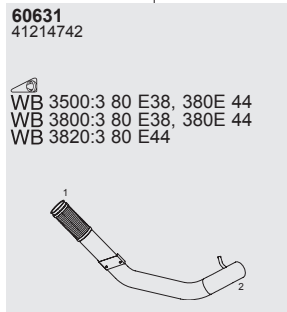
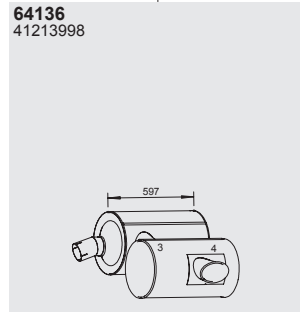
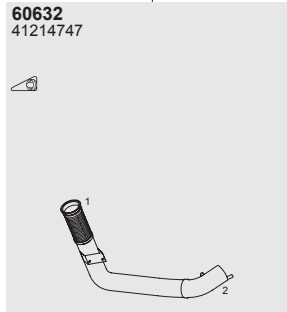

Mounting Parts

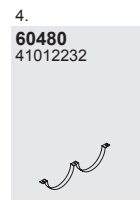
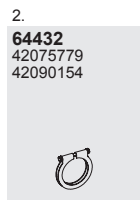
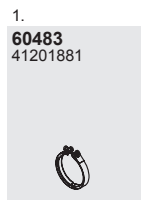

Series EUROTRAKKER CURSOR

Type

Euro III



WB 3800
190E 44
260E 38
260E 44

Front pipe

Silencer

64287
500301947

64289
41210296

64136
41213998

60639
41214836

4236342 ▶CHno
C086489 ▶CHno

60631
41214742

Mounting Parts

1.
64492
42092219

2.
64495
42075778
42090023
42081440

3.
64432
42075779
42090154

4.
60483
41201881

5.
60484
41012236

6.
60480
41012232

Horizontal
LHD
Standard

Series EUROTRAKKER CURSOR

Type

Euro III



WB 3500
720E 38

WB 3800
400E 38
400E 44

WB 4800
720E 44



WB 3500
260E 38
380E 38
380E 44

WB 3800
190E 38
190E 44
380E 38
380E 44

WB 3820
260E 38
260E 44
380E 44

WB 4200
190E 38
190E 44

WB 4500
190E 38
190E 44

WB 4800
260E 44

Horizontal
LHD
Standard

Front pipe

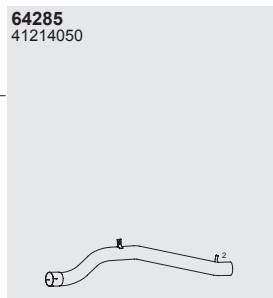
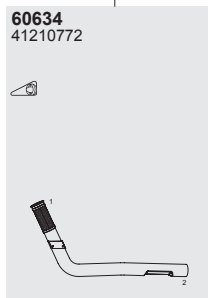

Silencer



Tail pipe

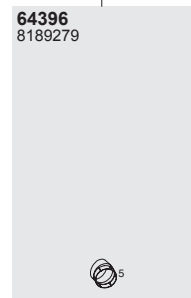

Mounting Parts

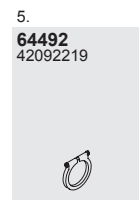
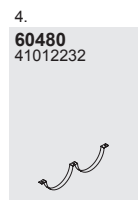
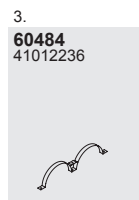
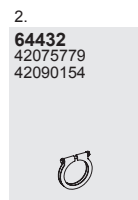
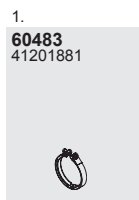

Series EUROTRAKKER CURSOR

Type

Euro III



WB 4250
340E 35
410E 35

WB 5000
340E 35

WB 5020
340E 35

Front pipe

Silencer

60634
41210772

Allt ypes
All chassis no's

64285
41214050

64110
41020596

Mounting Parts

1.
60483
41201881

2.
64432
42075779
42090154

3.
60482
41012236

4.
60480
41012232

Horizontal
LHD
Standard

Series EUROTRAKKER CURSOR

Type

Euro III



WB 4200
410E 38
410E 44

WB 4250
340E 38
340E 44
410E 38
410E 44
410E 48

WB 4700
340E 38
340E 44
410E 38
410E 44

WB 5020
340E 38
340E 44
410E 38
410E 44

WB 5820
410E 38
410E 44

Front pipe

Silencer

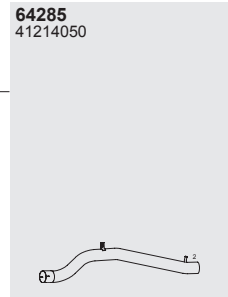
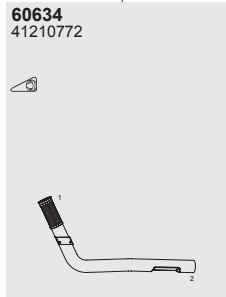

Mounting Parts

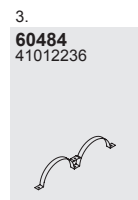
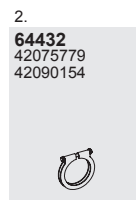
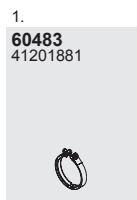

Horizontal
LHD
Standard

Series EUROTRAKKER CURSOR

Type

Euro III



WB 4700
410E 44

Silencer



Mounting Parts

1.
64432
42075779
42090154



2.
60482
41012236



3.
60480
41012232



Horizontal
LHD
Standard

Series EUROTRAKKER CURSOR

Type

Euro III



WB 3500
260E 35
380E 35

WB 3800
180E 24
190E 31
190E 35
380E 35

WB 4200
190E 31

Front pipe

64287
500301947

▶CHno 4236341
▶CHno C086488



64289
41210296

▶CHno 4236341
▶CHno C086488



60639
41214836

4236342 ▶CHno
C086489 ▶CHno
All types

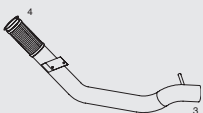

60631
41214742

4236342 ▶CHno
C086489 ▶CHno
WB 3800:1 80 E24, 380E 35

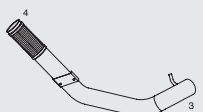

Silencer

64131
41020593

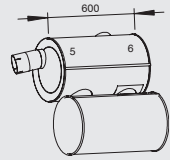

64906
41019510



64901
41201532



Tail pipe

64907
41201531



Mounting Parts

1.
64492
42092219



2.
64495
42075778
42090023
42081440



3.
64432
42075779
42090154



4.
60483
41201881



5.
60484
41012236



6.
60480
41012232



7.
00769
8139083



8.
64493
42091873
41019713
41016502



Vertical
LHD
Standard

Series EUROTRAKKER CURSOR

Type

Euro III



WB 3500
380E 35

WB 3800
190E 31
190E 35

WB 4200
180E 24
180E 27
190E 31
190E 35

WB 4500
190E 31

Front pipe

Silencer

Tail pipe

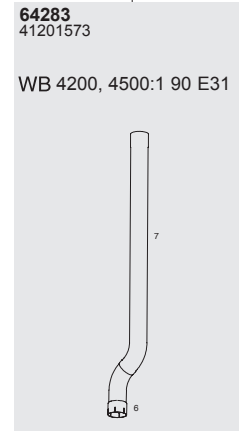
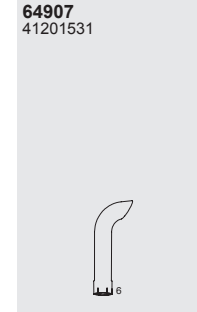
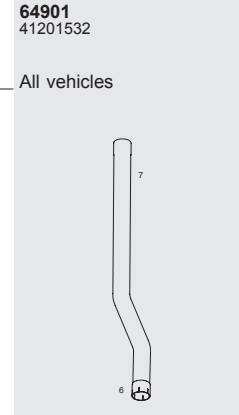
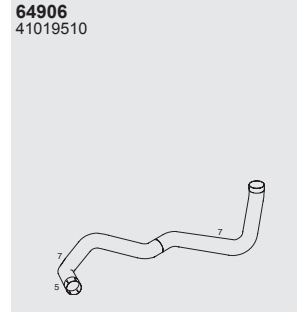
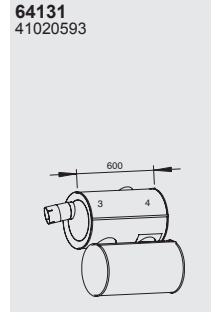
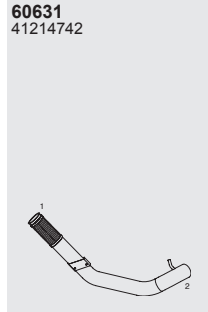

Mounting Parts

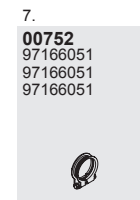
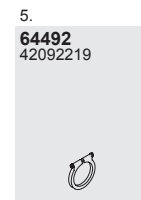
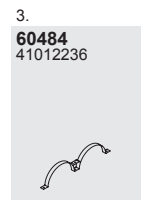
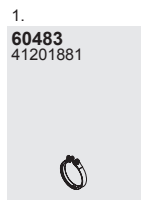

Vertical
LHD
Standard

Series EUROTRAKKER CURSOR

Type

Euro III



WB 3500
260E 35

WB 3800
190E 24
260E 31

WB 4200
190E 31
260E 31
260E 35

WB 4500
190E 24
190E 31
190E 35
260E 35

WB 4800
190E 27
260E 31

Front pipe

60632
41214747

Silencer

64131
41020593

64905
41019514

Tail pipe

69401
41201532

WB 3800:1 90 E24, 260E 31
WB 4200:1 90 E31, 260E 31,2 60 E35
WB 4500:1 90 E24, 190E 31,1 90 E35, 260E 35
WB 4800:1 90 E27, 260E 31

64907
41201531

Mounting Parts

1.
60483
41201881

2.
64432
42075779
42090154

3.
60484
41012236

4.
60480
41012232

5.
64492
42092219

6.
64493
42091873
41019713
41016502

7.
00769
8139083

64283
41201573

WB 3500, 4500:2 60 E35

Vertical
LHD
Standard

Series EUROTRAKKER CURSOR

Type

Euro III



WB 3500
400E 35



WB 3200
380E 35

WB 3500
260E 35

WB 3820
260E 31
380E 35

WB 4200
190E 31
260E 31
260E 35

WB 4500
190E 31
260E 31
260E 35

WB 4800
260E 31

WB 5100
190E 31

Front pipe

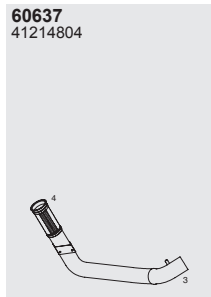
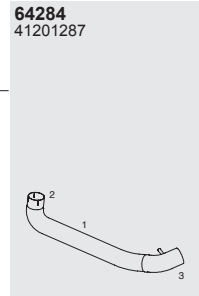
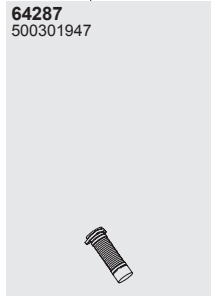

Silencer

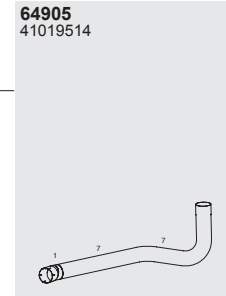
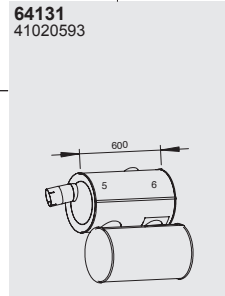

Tail pipe

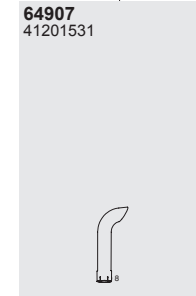
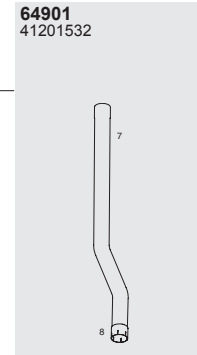

Mounting Parts

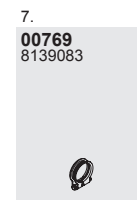
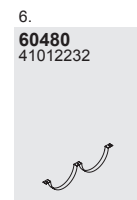
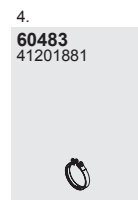
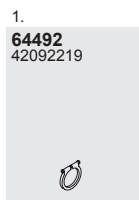

Vertical
LHD
Standard

Series EUROTRAKKER CURSOR

System No.: 128101014

Type

Euro III



WB 3200
440E 38
440E 44



WB 3500
260E 38
380E 38
380E 44

WB 3820
260E 38
260E 44

WB 4200
190E 38
380E 38
380E 44

WB 4500
260E 38

WB 5100
190E 38

Front pipe

60623
41214747

Silencer

64134
41213999

64905
41019514

Tail pipe

64901
41201532

WB 3200:4 40 E38.
WB 3500:2 60 E38.
WB 3820:2 60 E38, 260E 44.
WB 4200:1 90 E38, 380E 44.
WB 4500:2 60 E38.
WB 5100:1 90 E38

64907
41201531

Mounting Parts

1.
60483
41201881

2.
64432
42075779
42090154

3.
60484
41012236

4.
60480
41012232

5.
64492
42092219

6.
64493
42091873
41019713
41016502

7.
00769
8139083

64283
41201573

WB 3200:4 40 E44.
WB 3500:3 80 E38, 380E 44.
WB 4200:3 80 E38

Vertical
LHD
Standard

Series EUROTRAKKER CURSOR

Type

Euro III



WB 3500
720E 44



WB 3500
260E 38
720E 44

WB 3800
190E 44
260E 38
400E 38

WB 4500
190E 38

WB 4800
380E 38

Front pipe

Silencer

Tail pipe

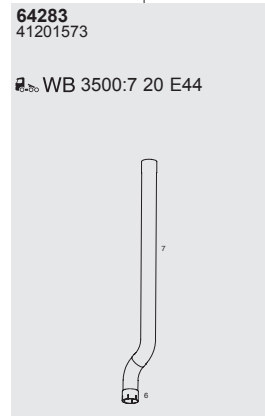
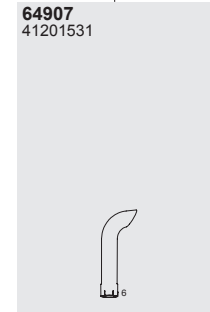
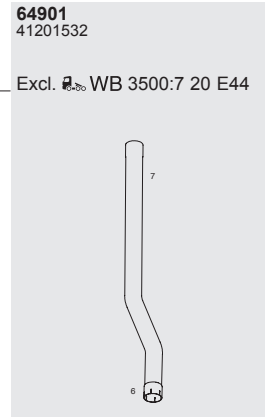
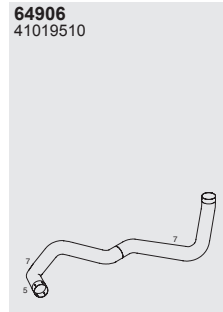
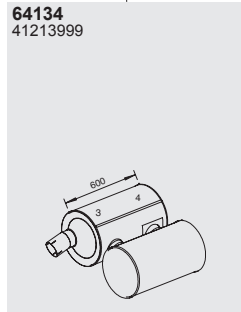
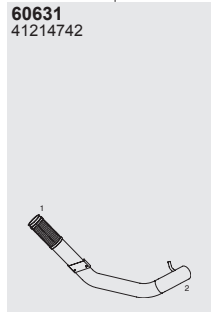

Mounting Parts

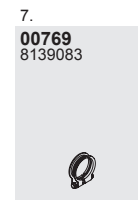
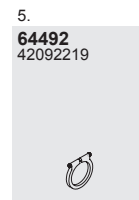
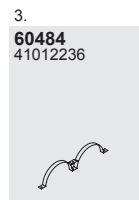
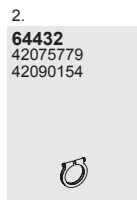
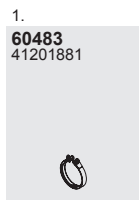

Vertical
LHD
Standard

Series EUROTRAKKER CURSOR

Type

Euro III



WB 3200, 3820
380E 38

Silencer

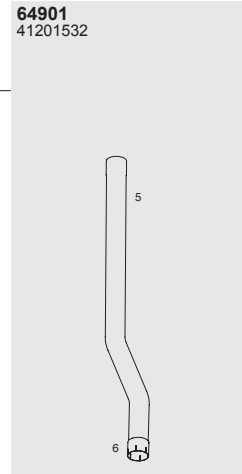
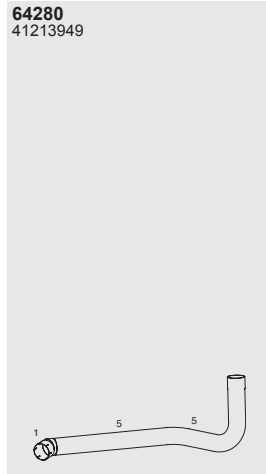
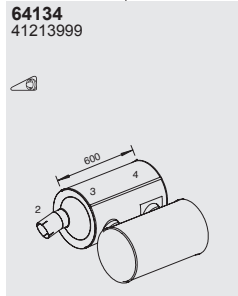

Tail pipe

Mounting Parts

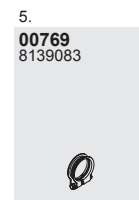
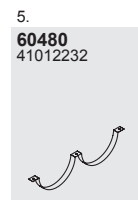
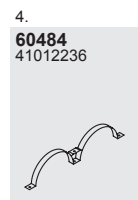
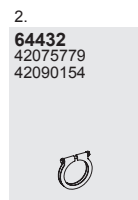
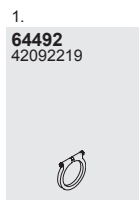

Vertical
LHD
Standard

Series EUROTRAKKER CURSOR

Type

Euro III



WB 3500
260E 38
260E 44
380E 44

WB 3820
260E 38

Front pipe

Silencer

Tail pipe

64287
500301947

►CHno 4236341
►CHno C086488

64289
41210296

64134
41213999

64906
41019510

64901
41201532

WB 3500:2 60 E38, 260 E244
WB 3820:2 60 E38

64907
41201531

60639
41214836

4236342 ►CHno
C086489 ►CHno

60631
41214742

64283
41201573

WB 3500:2 60 E38, 260 E344,3 80 E44

Mounting Parts

1.
64492
42092219

2.
64495
42075778
42090023
42081440

3.
64435
42075779
42090154

4.
60483
41201881

5.
60484
41012236

6.
60480
41012232

7.
00769
8139083

8.
64493
42091873
41019713
41016502

Vertical
LHD
Standard

Series EUROSTAR

Type

Euro II



④X②
190E 52

⑥X②
240E 52

⑥X④
260E 52



⑥X②
400E 52

④X②
⑥X④
440E 52

Front pipe

Silencer

64673
42092241



64652
8165814

Left hands ide



64549
8139368

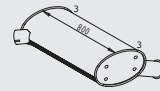

64653
8165810

Right hands ide

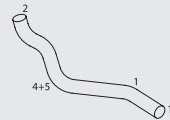

Mounting Parts

1.
64432
42075779
42090154



2.
00772
41800522



3.
64466
41016565
8138432



4.
64461
8165828



5.
64491
2491711



Horizontal
LHD
Standard

Series EUROSTAR CURSOR

Type

Euro II/III

WB 3650
440E 43

WB 3800
440E 39
440E 43

WB 5100, 5700,
6300
190E 39



WB 3650
440E 39

WB 4800, 5100
260E 39
260E 43

WB 5100, 5700,
6300
190E 43

Front pipe

Silencer

60616
41210895

Excl. WB 3800:
440E 39,4 40 E43

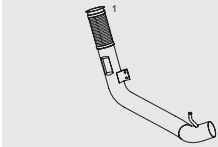

64123
41210652

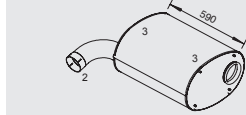

60611
41210818

WB 3800:4 40 E39, 440E 43

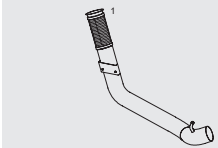

Mounting Parts

1.
60483
41201881



2.
64432
42075779
42090154



3.
64466
41016565
8138432



Horizontal
LHD
Standard

Series EUROSTAR CURSOR

Type

Euro II/III



WB 3650
440E 39
440E 43

WB 3800
440E 39
440E 43

WB 5700
190E 39



WB 4200
260E 39
260E 43

WB 4500
190E 39
190E 43
260E 39
260E 43

WB 4800
260E 39
260E 43

WB 5100
190E 39
190E 43
260E 39
260E 43

WB 5700
190E 39
190E 43
260E 39
260E 43

WB 6050
260E 39
260E 43

WB 6300
190E 43

Horizontal
LHD
Standard

Front pipe

Silencer

Tail pipe

60615
41213532

WB 5700:1 90 E39.
 WB 5100:1 90 E39.
 WB 4500, 4800, 5100:2 60 E39, 260E 43.

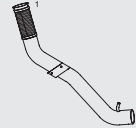

64128
41210965

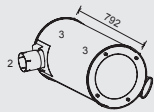

64969
41021461

WB 3650, 3800:4 40 E39, 440E 43.
 WB 5700:1 90 E39.
 WB 4200, 4500, 4800, 5100, 6050:2 60 E39, 260E 43.
 WB 4500, 5100, 5700:1 90 E39, 190E 43.
 WB 6300:1 90 E43.



60611
41210818

WB 3650, 3800:4 40 E39, 440E 43.
 WB 4200:2 60 E39, 260E 43.
 WB 4500, 5100, 5700:1 90 E39, 190E 43, 2 60 E39, 260E 43.
 WB 4800:2 60 E39, 260E 43.
 WB 6050:2 60 E39, 260E 43.

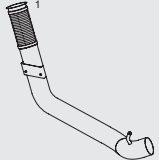

64908
41021472

WB 3650:4 40 E39.
 WB 3800:4 40 E39, 440E 43



Mounting Parts

1.
60483
41201881



2.
64432
42075779
42090154



3.
64488
41015983
8138309



4.
64428
41021481



Series EUROSTAR CURSOR

Type

Euro III



WB 3650, 3800
440E 46
440E 48



WB 4200, 4500,
4800, 5100,
5700, 6050
260E 48

Front pipe

60611
41210818

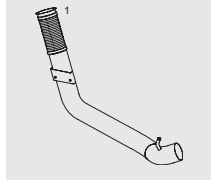

Silencer

64127
41213758

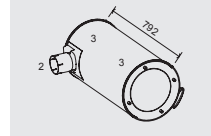

Tail pipe

64969
41021461

WB 3650, 3800:4 40 E46, 440E 48
 WB 4200, 4500, 4800, 5100, 5700, 6050:2 60 E48



64908
41021472

WB 3650:4 40 E46, 440E 48
WB 3650, 3800:4 40 E48



Mounting Parts

1.
60483
41201881



2.
64432
42075779
42090154



3.
64488
41015983
8138309



4.
64428
41021481



Horizontal
LHD
Standard

Series EUROTECH

Type

Euro II



180E 24
180E 27
190E 24
190E 27

Front pipe

Silencer

64674
98453453

64648
41021848

64545
8137210

64670
98453624

64185
41019322
41019045

Extra noise reduction

64969
41021461

Mounting Parts

1.
64428
41021481

2.
28012
61597491
8572665
61597791

3.
64432
42075779
42090154

4.
64488
41015983
8138309

Horizontal
LHD
Standard

Series EUROTECH

Type

Euro II



180E 30
180E 34
190E 30



400E 30
400E 34

Front pipe

Silencer

64688
98452488

64687
98460607
98451501
98451581

64545
8137210

64185
41019322
41019045

Extra noise reduction

64969
41021461

Mounting Parts

1.
64428
41021481

2.
00784
42090023

3.
64432
42075779
42090154

4.
64488
41015983
8138309

Horizontal
LHD
Standard

Series EUROTECH

Type

Euro II



180E 30
180E 34
190E 30



400E 30
400E 34

Front pipe

64688
98452488

64687
98460607
98451501
98451581

Silencer

64545
8137210

68185
41019322
41019045

Extra noise reduction

64969
41021461

Mounting Parts

1.
64428
41021481













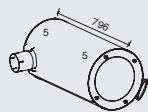

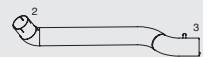

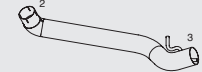

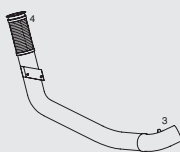

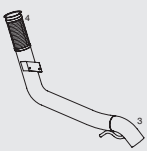





2.
00784
42090023

3.
64432
42075779
42090154

4.
64488
41015983
8138309

Horizontal
LHD
Standard

Series EUROTECH CURSOR

Type	Front pipe	Silencer	Tail pipe															
<p>Euro III</p> <p></p> <p>WB 3650, 3800 440E 31 440E 35</p>	<p>64287 500301947</p> 	<p>64185 41019322 41019045</p> 	<p>64969 41021461</p> <p>Allv ehicles</p> 															
<p></p> <p>WB 3800, 4200, 4500, 4800, 5100, 5700 190E 24 190E 31 190E 35 260E 24 260E 31 260E 35</p>	<p>64278 41201270</p> <p>►CHno 4236341 ►CHno C086488 Allv ehicles</p> 	<p>64281 41210458</p> <p>►CHno 4236341 ►CHno C086488  WB 4500, 4800:1 90 E24, 260E 24</p> 	<p>64908 41021472</p> <p> WB 3800:4 40 E35</p> 															
<p>WB 6050 260E 24 260E 31 260E 35</p>	<p>60633 41214780</p> <p>4236342 ►CHno C086489 ►CHno Allv ehicles</p> 																	
<p>WB 6300, 6700 190E 24 190E 31 190E 35</p>	<p>60620 41214789</p> <p>4236342 ►CHno C086489 ►CHno  WB 4500, 4800:1 90 E24, 260E 24</p> 																	
<p>Horizontal LHD Standard</p>		<p>Mounting Parts</p> <table border="0"> <tr> <td>1.</td> <td>2.</td> <td>3.</td> <td>4.</td> <td>5.</td> </tr> <tr> <td>64428 41021481</td> <td>64495 42075778 42090023 42081440</td> <td>64432 42075779 42090154</td> <td>60483 41201881</td> <td>64488 41015983 8138309</td> </tr> <tr> <td></td> <td></td> <td></td> <td></td> <td></td> </tr> </table>	1.	2.	3.	4.	5.	64428 41021481	64495 42075778 42090023 42081440	64432 42075779 42090154	60483 41201881	64488 41015983 8138309						
1.	2.	3.	4.	5.														
64428 41021481	64495 42075778 42090023 42081440	64432 42075779 42090154	60483 41201881	64488 41015983 8138309														
																		

Series EUROTECH CURSOR

Type

Euro III



WB 3800
190E 24
260E 24

WB 4200
190E 24
260E 24

WB 4500
260E 24

WB 4800
190E 24

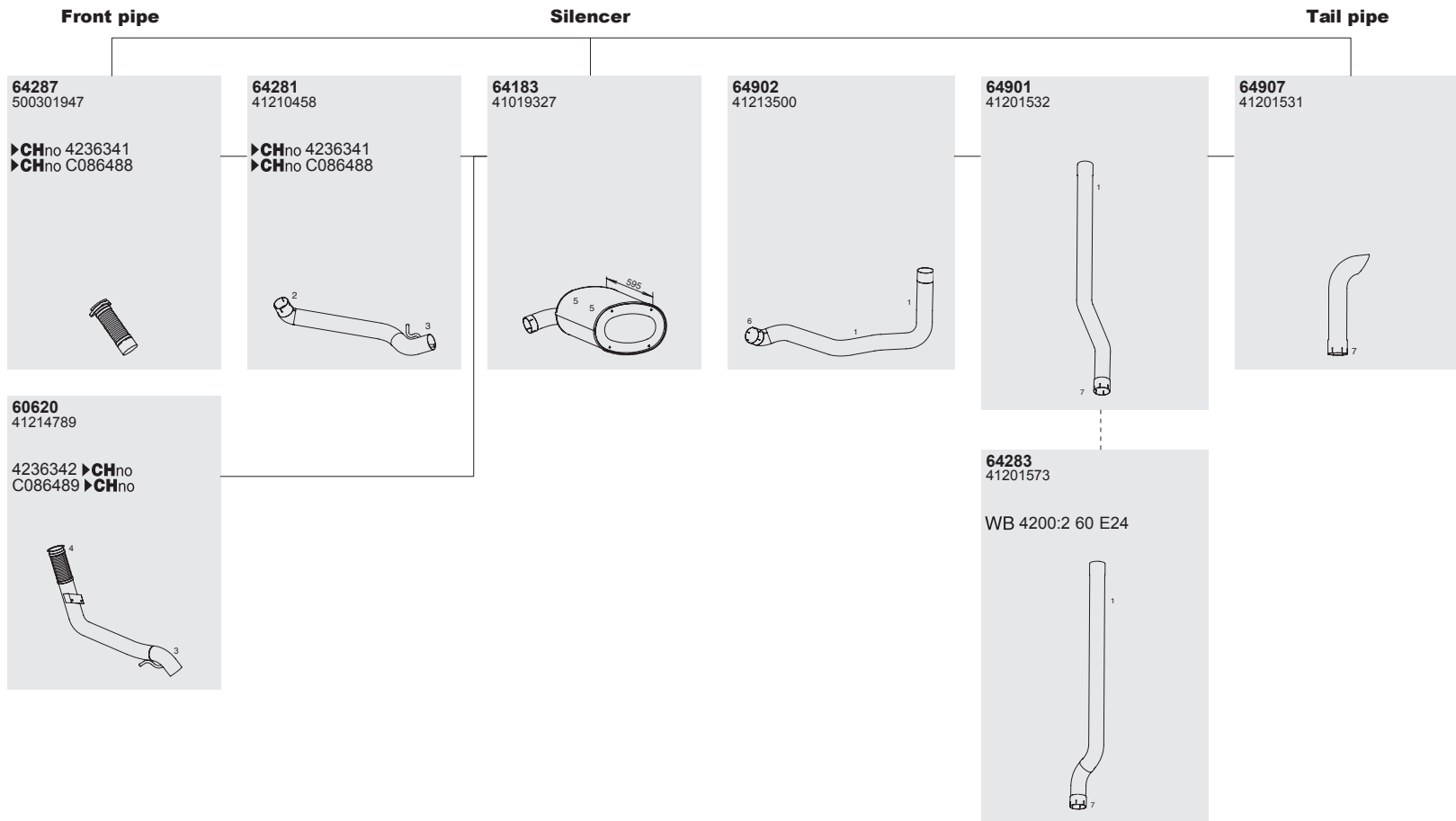

Mounting Parts

- | | | | | | | |
|-------------------------------|--|--|--------------------------------|---|--------------------------------|--|
| 1.
00769
8139083 | 2.
64495
42075778
42090023
42081440 | 3.
64432
42075779
42090154 | 4.
60483
41201881 | 5.
64466
41016565
8138432 | 6.
64492
42092219 | 7.
64493
42091873
41019713
41016502 |
|-------------------------------|--|--|--------------------------------|---|--------------------------------|--|

Vertical
LHD
Standard

Series EUROTECH CURSOR

Type

Euro III



WB 4200
190E 31
260E 31
260E 35

WB 4500
190E 31
190E 35
260E 31
260E 35

WB 4800
190E 31
190E 35
260E 31
260E 35

WB 5100
190E 31
190E 35
260E 31
260E 35

WB 5700
190E 31
190E 35
260E 35

WB 6050
260E 31
260E 35

WB 6300
190E 31
190E 35

WB 6700
190E 31

Front pipeT

Silencer

ail pipe

64286
41213621

▶CHno 4236341
▶CHno C086488

WB 4200:2 60 E31,260E 35
WB 4500:2 60 E31,260E 35
WB 4800:2 60 E31,260E 35
WB 5100:1 90 E31,190E 35,260E 31,260E 35
WB 5700:1 90 E31,190E 35

64542
8137212

64969
41021461

60638
41214795

WB 4200:1 90 E31,260E 31,260E 35
WB 4500:1 90 E31,190E 35,260E 31,260E 35
WB 4800:1 90 E31,190E 35,260E 35
WB 5100:1 90 E31,190E 35,260E 31,260E 35
WB 5700:1 90 E31,190E 35,260E

Mounting Parts

1.
64428
41021481

2.
60483
41201881

3.
64432
42075779
42090154

4.
64488
41015983
8138309

Horizontal
LHD
Standard

Series EUROTECH CURSOR

Type

Euro III



WB 3650
440E 39
440E 43

WB 3800
440E 39
440E 43



WB 4200
190E 43
260E 39
260E 43

WB 4500
190E 39
190E 43
260E 39
260E 43

WB 4800
260E 39
260E 43

WB 5100
190E 39
190E 43
260E 39
260E 43

WB 5700
190E 39
190E 43
260E 39
260E 43

WB 6050
260E 39
260E 43

WB 6300
190E 39
190E 43

Horizontal
LHD
Standard

Front pipeT

Silencer

ail pipe

60615
41213532

WB 4200:2 60 E39, 260E 43
WB 4500:2 60 E39, 260E 43
WB 4800:2 60 E39, 260E 43
WB 5100:1 90 E43, 260E 39,2 60 E43
WB 5700:1 90 E39, 190E 43

64128
41210965

64969
41021461

60611
41210818

Allv ehicles

Mounting Parts

1.
60483
41201881

2.
64432
42075779
42090154

3.
64488
41015983
8138309

4.
64428
41021481

Series EUROTECH CURSOR

Type

Euro III



WB 3805
190E 31

WB 4500
260E 35

Front pipe

Silencer

Tail pipe

64287
500301947

►CHno 4236341
►CHno C086488



64278
41201270

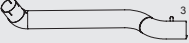

64183
41019327

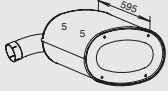

64902
41213500



64901
41201532



64907
41201531



60633
41214780

4236342 ►CHno
C086489 ►CHno



Mounting Parts

1.
64492
42092219



2.
64495
42075778
42090023
42081440



3.
64432
42075779
42090154



4.
60483
41201881



5.
64466
41016565
8138432



6.
00969
8139083



7.
64493
42091873
41019713
41016502



Vertical
LHD
Standard

Series EUROTECH CURSOR

Type

Euro III



WB 4200
190E 24
260E 31
260E 35

WB 4500
190E 35
260E 31
260E 35

WB 4800
190E 24
190E 31
260E 31

WB 5100
190E 24
190E 31
190E 35
260E 31
260E 35

WB 5700
190E 24
190E 31

Front pipe

64287
500301947

▶CHno 4236341
▶CHno C086488



64278
41201270

▶CHno 4236341
▶CHno C086488



60633
41214780

4236342 ▶CHno
C086489 ▶CHno

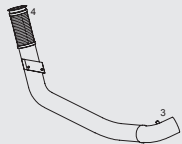

Silencer

64126
41019324



64282
41201530

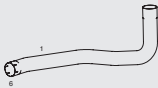

Tail pipe

64901
41201532

WB 4200:1 90 E24, 260E 31, 260 E35
WB 4500:2 60 E31, 260E 35
WB 4800:1 90 E24, 190E 31, 260 E31
WB 5100:1 90 E24, 190E 31, 190 E35, 260E 31, 260E 35
WB 5700:1 90 E24, 190E 31

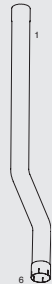

64907
41201531



64283
41201573

WB 4200:2 60 E31
WB 4500:1 90 E35
WB 4800:2 60 E31
WB 5100:2 60 E35
WB 5700:1 90 E31



Mounting Parts

1.
00969
8139083



2.
64495
42075778
42090023
42081440



3.
64432
42075779
42090154



4.
60483
41201881



5.
64488
41015983
8138309



6.
64493
42091873
41019713
41016502



Vertical
LHD
Standard

Series EUROTECH CURSOR

Type

Euro III

►CHno4236341
►CHnoC086488

WB 4500
260E 35

Front pipe

Silencer

Tail pipe

642868
41213621

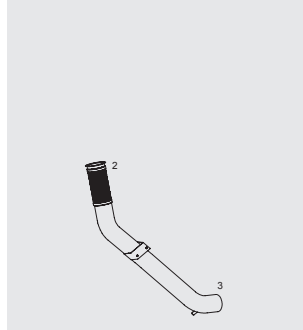

64126
41019324

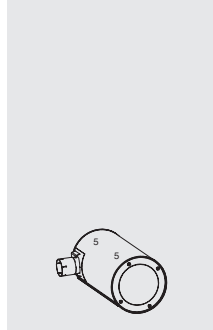

64282
41201530

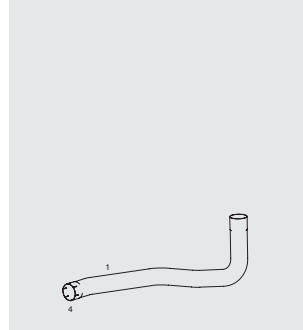

64901
41201532

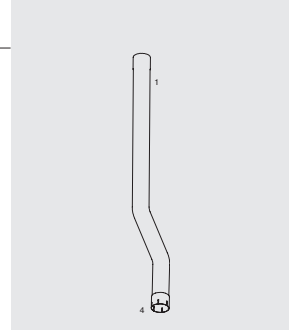

64907
41201531



Mounting Parts

1.
00969
8139083



2.
60483
41201881

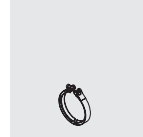

3.
64432
42075779
42090154



4.
64493
42091873
41019713
41016502

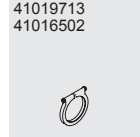

5.
64488
41015983
8138309



Vertical
LHD
Standard

Series EUROTECH CURSOR

Type

Euro III



WB 3800
440E 43



WB 4500
190E 43

WB 4800
260E 39

WB 5700
260E 43

Front pipe

60611
41210818

Silencer

64183
41019327

WB 3800:4 40 E43
WB 5700:2 60 E43

64126
41019324

WB 4500:1 90 E43
WB 4800:2 60 E39

64282
41201530

64901
41201532

Tail pipe

64907
41201531

Mounting Parts

1.
60483
41201881

2.
64432
42075779
42090154

3.
64488
41015983
8138309

4.
64493
42091873
41019713
41016502

5.
00969
8139083

6.
64466
41016565
8138432

Vertical
LHD
Standard

Series EUROTECH CURSOR

Type

Euro III

 WB 3650
440E 43

 WB 3800
440E 35
440E 39
440E 43

 WB 3800
190E 35
440E 39
440E 43

WB 4800
260E 31
260E 35
260E 39
260E 43

WB 5100
190E 31
190E 35
260E 35
260E 43

WB 5500
190E 35
190E 39
190E 43

WB 5700
190E 31
190E 35
190E 39
190E 43
260E 35
260E 43

WB 6300
190E 31
190E 39



WB 6700
190E 31
190E 35

Horizontal
LHD
Standard

Front pipe

Silencer

60638
41214795

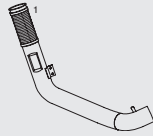

 WB 3800:4 40 E35.
 WB 4800:2 60 E31, 260E 35.
 WB 5100, 5700:1 90 E31, 190E 35,2 60 E35
WB 6300:1 90 E31:
WB 6700:1 90 E31, 190E 35

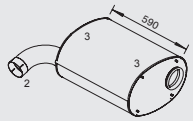

64123
41210652



60616
41210895

 WB 3650: 440E43.
WB 3800: 440E35.
 WB 3800: 190E35, 440E39, 440E43.
WB 4800: 260E39, 260E43.
WB 5100: 260E43.
WB 5500: 190E35, 190E39, 190E43.
WB 5700: 190E31

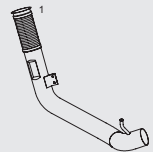

60611
41210818

 WB 3800:4 40 E39, 440E 43



Mounting Parts

1.
60483
41201881



2.
64432
42075779
42090154



3.
64466
41016565
8138432



Series EUROTECH/EUROSTAR

Type

Euro II



④X②
180E 42 MP
190E 42

⑥X②
240E 42

⑥X④
260E 42



⑥X②
400E 42

④X②
⑥X④
440E 42

Front pipe

Silencer

64683
41009549
8132862
8165720



64685
8137150
8162322
41011873



64684
8137110



64542
8137212

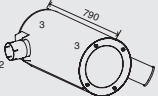

64657
41027654
41019041



64185
41019322
41019045

Extra noise reduction

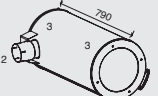

64969
41021461



64183
41019327

Extra noise reduction

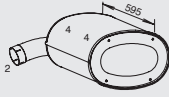

64963
41021517

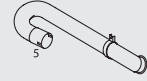

Mounting Parts

1.
64485
42075987



2.
64432
42075779
42090154



3.
64488
41015983
8138309



4.
64466
41016565
8138432



5.
64492
42092219



6.
64428
41021481



Horizontal
LHD
Standard

Series EUROTECH/EUROSTAR

Type

Euro II



④X②
180E 42 MP
190E 42

⑥X②
240E 42

⑥X④
260E 42



⑥X②
400E 42

④X②
⑥X④
440E 42

Front pipe

64683
41009549
8132862
8165720



64666
8165736

▶CHno 148917



64661
42111508



64667
8165733

▶CHno 148917



64662
41007578

148917 ▶CHno



64669
41007575

148917 ▶CHno



Silencer

64542
8137212

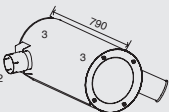

64185
41019322
41019045

Extra noise reduction

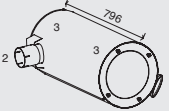

64969
41021461



Mounting Parts

1.
64485
42075987



2.
64432
42075779
42090154



3.
64488
41015983
8138309



4.
64457
8165725



5.
64428
41021481



Horizontal
LHD
Standard

Series EUROTECH/EUROSTAR

Type

Euro II

EuroTech



④X②
180E 34 MP
180E 38 MP
190E 34
190E 38

⑥X②
240E 34
240E 38

⑥X④
260E 38



④X②
⑥X②
⑥X④
400E 34 MP
400E 38

④X②
⑥X②
⑥X④
440E 34
440E 38

EuroStar



④X②
190E 38

⑥X②
240E 38

⑥X②
400E 38



④X②
⑥X④
440E 38

Horizontal
LHD
Standard

Front pipe

Silencer

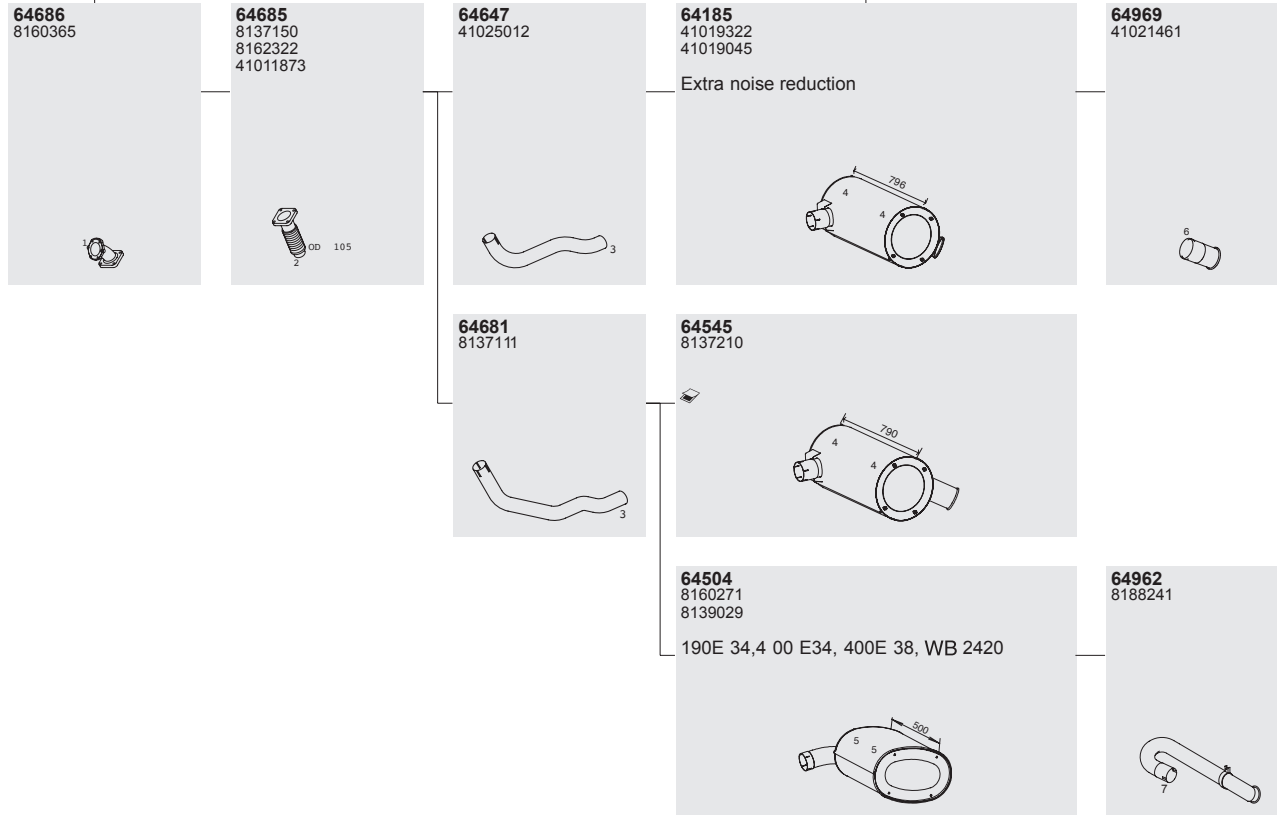

Mounting Parts

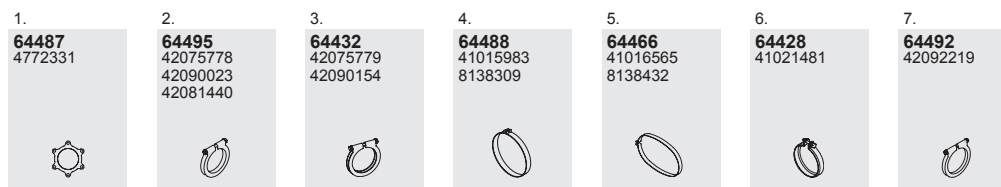

Series STRALIS

Type

Euro III
02/2002 →

 260S30 AD
260S31 AD
190S40 AS
190S43 AS
260S40 AS
260S43 AS

 440S40
AD/AS/AT
440S43
AD/AS/AT
440S48 AS
440S54 AS

LOW-CHASSIS
190S48 AS
260S43 AS
260S48 AS

LOW-TRACTOR
440S43 AT
440S48 AS
440S54 AS

**CAR
TRANSPORTER**
190S40 AT
190S43 AT
440S40 AT
440S43 AT

 **F2BE0681**
7,8l tr.
6 cyl.
218K W/296H P
218K W/310H P
220K W/310H P



 **F3AE0681**
10,3l tr.
6 cyl.
294K W/400H P
316K W/430H P

 **F3BE0681**
12,9l tr.
6 cyl.
353K W/480H P
397

Horizontal
LHD
Standard

Front pipe

60611
41210818

 WB 4500, 260S30AD
WB 4200, 260S31AD
WB 5100,5700: 190S40 AS,190S43 AS
WB 4800,5100: 260S40AS, 260S43 AS
 WB 3650,3800:
440S40AD/AS/AT, 440S43 AD/AS/AT,
440S48 AS, 440S54 AS

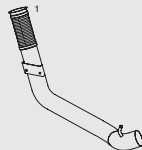

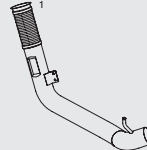

60616
41210895

CARTRAN
WB 5500,5700 190S40AT
WB 5500 190S43AT
WB 3800 440S40/43AT
LOW-CH/TR
WB 4500,4800,5100 260S48AS
WB 5100,5700 190S48AS
WB 4500 260S43AS
WB 3650 440S43AT,440S48/54AS



Silencer

64123
41210652

 F2BE0681
260S30 AD, 260S31 AD
 F3AE0681
190S40 AS/AT, 190S43 AS/AT,
260S40 AS, 260S43 AS,
440S40 AD/AS/AT, 440S43 AD/AS/AT

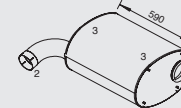

64129
41214215

 F3BE0681
190S48 AS, 260S48 AS,
440S48 AS, 440S54 AS

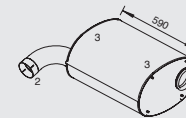

Mounting Parts

1.
60483
41201881



2.
64432
42075779
42090154



3.
64466
41016565
8138432





Series STRALIS

Type

Euro III
02/2002 →

 190S27 AD/AT
190S30 AD
190S31 AD/AT
190S35 AD/AT
190S40
AD/AS/AT
190S43
AD/AS/AT
190S48 AS
260S27 AD/AT
260S30 AD/AT
260S31 AD/AT
260S35 AD/AT
260S40
AD/AS/AT
260S43
AD/AS/AT
260S48 AS
260S54 AS

 440S31 AD/AT
440S35 AD/AT
440S40
AD/AS/AT
440S43
AD/AS/AT
440S48 AS
440S54 AS

 **F2BE0681**
7,8l tr. 6 cyl.
200K W/272H P
218K W/296H P
218K W/310H P
220K W/310H P
259K W/352H P

 **F3AE0681**
10,3l tr. 6 cyl.
294K W/400H P
316K W/430H P

 **F3BE0681**
12,9l tr./ 6 cyl.
353K W/480H P
397 KW/540 HP

Horizontal
LHD
Standard

Front pipe

60611
41210818

 Mechanical/Mixed suspension



60615
41213532

 Mixed/Pneumatic suspension
260S40 AD/AT, 260S43 AD/AT

Pneumatic suspension
WB 5700:
190S40 AS, 190S43 AS,
190S48 AS
WB 4200-6050:
260S40 AS, 260S43 AS,
260S48 AS, 260S54 AS

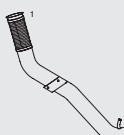

Silencer

64185
41019322
41019045

 **F2BE0681**
190S27 AD/AT, 190S30 AD,
190S31 AD/AT, 190S35 AD/AT,
260S27 AD/AT, 260S30 AD/AT,
260S31 AD/AT, 260S35 AD/AT,
440S31 AD/AT, 440S35 AD/AT

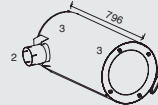

64128
41210965

 **F3AE0681**
190S40 AD/AS/AT, 190S43 AD/AS/AT,
260S40 AD/AS/AT, 260S43 AD/AS/AT,
440S40 AD/AS/AT, 440S43 AD/AS/AT

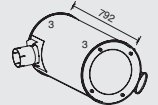

64127
41213758

 **F3BE0681**
190S48 AS, 260S48 AS,
260S54 AS, 440S48 AS,
440S54 AS

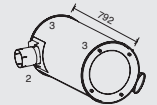

Tail pipe

64969
41021461



64908
41021472

 WB 3650,3800:
440S31 AT, 440S35 AT,
440S48 AS, 440S54 AS

WB 3800:
440S40 AT, 440S43 AS,
440S40 AS



Mounting Parts

1.
60483
41201881



2.
64432
42075779
42090154



3.
64488
41015983
8138309



4.
64428
41021481



Series STRALIS

Type

Euro III
02/2002 →

190S27 AD/AT
190S30 AD
190S31 AD/AT
190S35 AD
190S40 AD/AT
190S43 AD/AT
260S27 AD
260S30 AD
260S31 AD/AT
260S35 AD
260S40 AD/AT
260S43 AD/AT

440S35 AD
440S40 AD
440S43 AD

F2BE0681
7,8l tr.
6 cyl.
200K W/272H P
218K W/296H P
228K W/310H P
259K W/352H P

F3AE0681
10,3l tr.
6 cyl.
294K W/400H P
316K W/430H P

Front pipe

60611
41210818

Mechanical/Mixed suspension
Active dayc ab (AD)
Active time cab(AT)

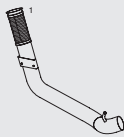

Silencer

64126
41019324

Active dayc ab (AD)
Excl. WT-MD 3060P
Active time cab(AT)

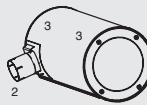

64282
41201530



64183
41019327

Active dayc ab (AD)
WT-MD 3060P



64902
41213500



Tail pipe

64901
41201532

Active dayc ab (AD)



64907
41201531



64283
41201573

190S27 AT, WB 6300, 190S31 AT, WB 5100
190S40 AT, WB 4500, 190S43 AT, WB 5700
260S31 AT, WB 4200, 260S40 AT, WB 4200
260S43 AT, WB 4800

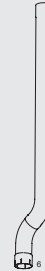

7.
64417
41016647



6.
64493
42091873
41019713
41016502



Mounting Parts

1.
60483
41201881



2.
64432
42075779
42090154



3.
64488
41015983
8138309



4.
64466
41016565
8138432



5.
64492
42092219



Vertical
LHD
Standard

SOYLU / EURO I, II, III

MAN

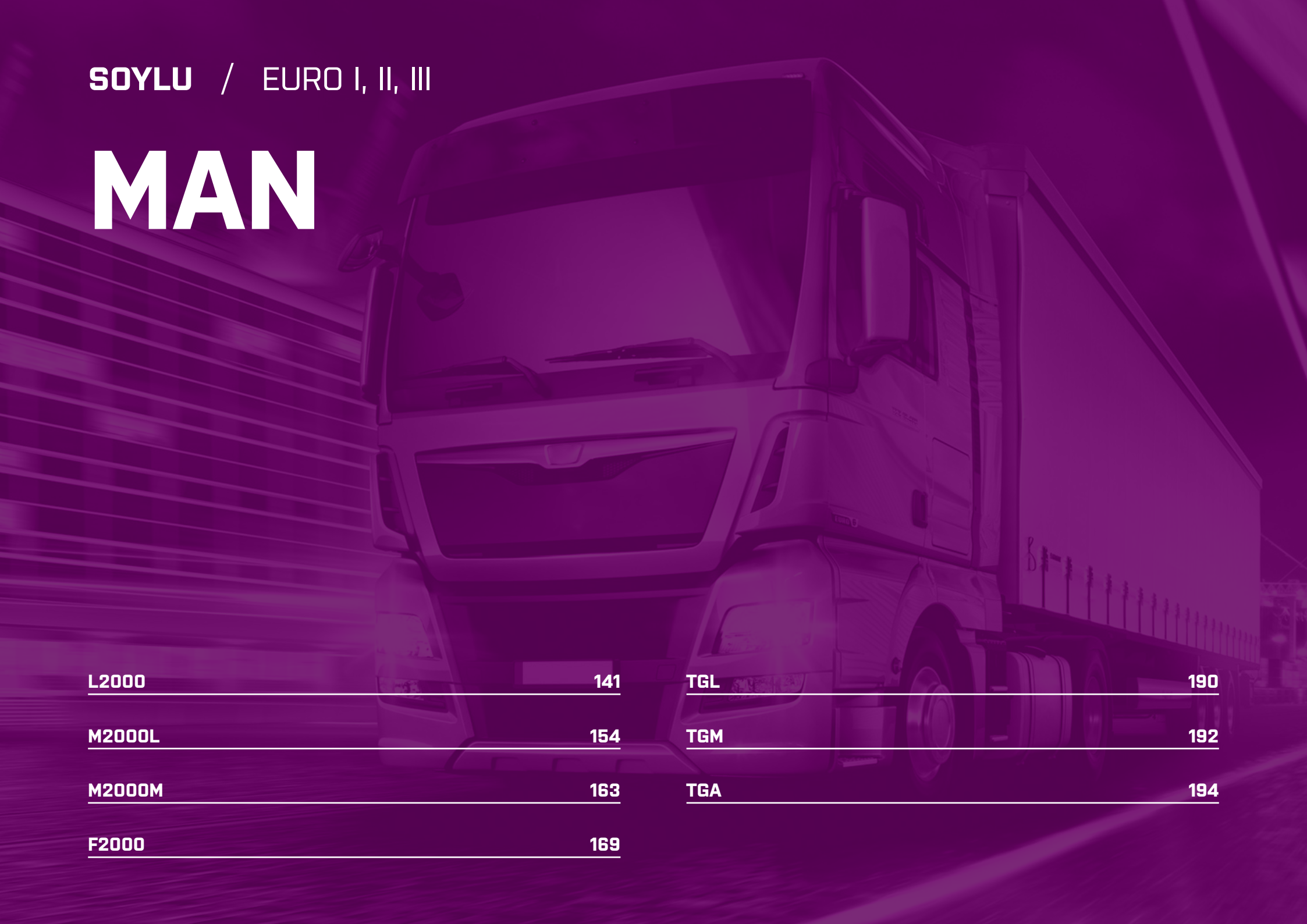

L2000	141	TGL	190
M2000L	154	TGM	192
M2000M	163	TGA	194
F2000	169		

Series L2000

Type

Euro II/III



D0824 LFL
4 cyl.
81 KW/110 HP
114K W/155H P
118K W/160H P

D0824F L
4 cyl.
75 KW/102 HP

L20
6-9t on.
05/93 →

L24
8-10 ton.
05/93 → 13/06

L33
6-9t on.
05/93 →

L35
9-10 ton.
07/93 → 13/06

L40
10 ton.
WB 4900
14/97 →

L42
8t on.
12/04 →

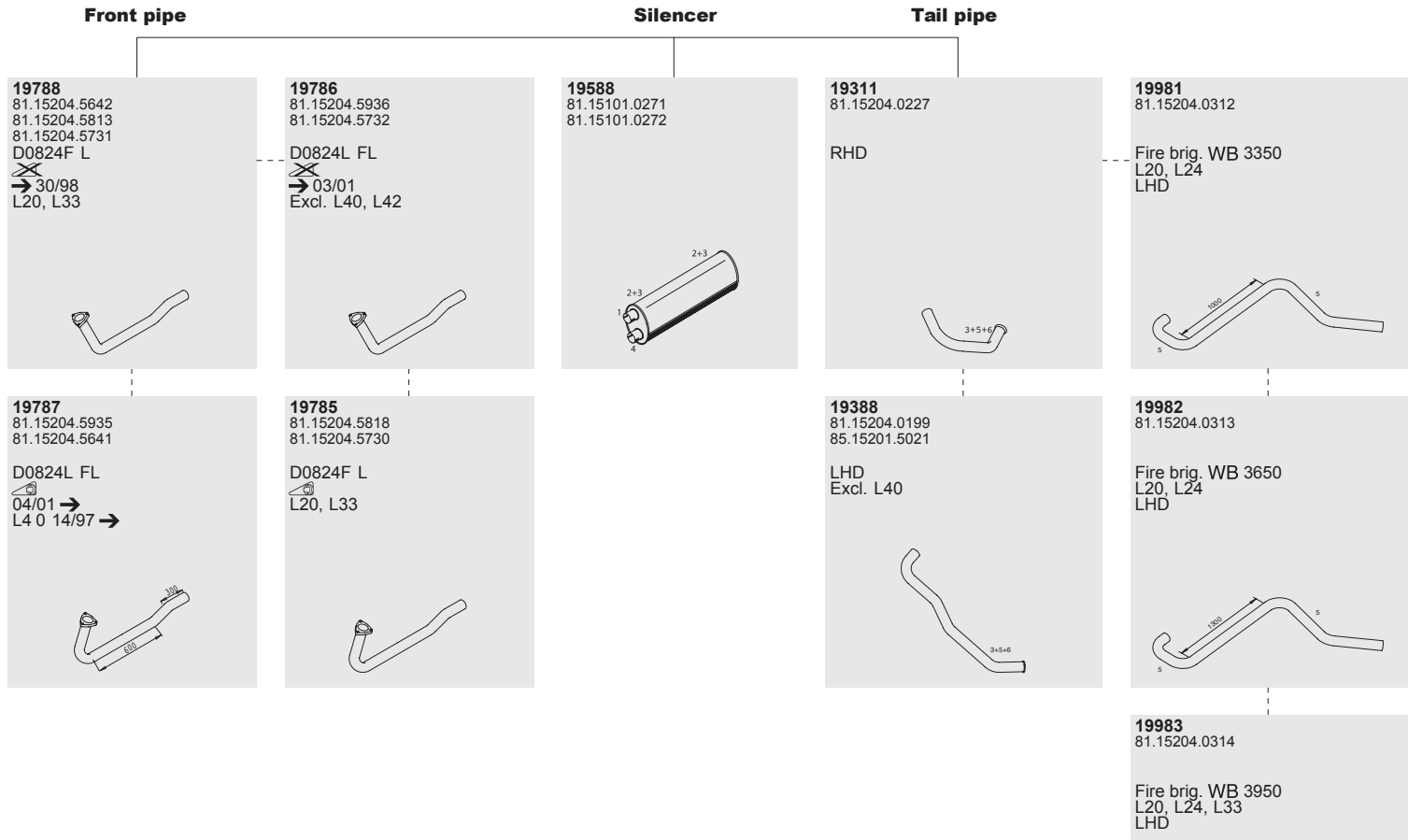

Mounting Parts

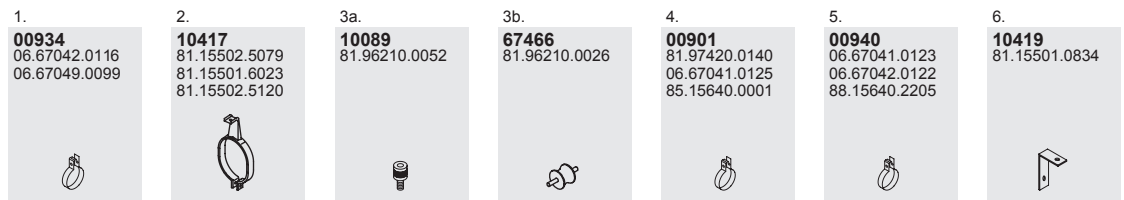

Horizontal
LHD/RHD
Standard

Series L2000

Type

EuroII/III



☞ D0824 LFL
4 cyl.
81 KW/110 HP
114K W/155H P
118K W/160H P

☞ D0824 FL
4 cyl.
75 KW/102 HP

L20
6-9t on.
05/93 →

L24
8-10 ton.
05/93 → 13/06

L33
6-9t on.
05/93 →

L35
9-10 ton.
07/93 → 13/06

Front pipe

19694
81.15204.5807

D0824 FL
L20, L33

19645
81.15210.0065

19641
81.15204.0326

19588
81.15101.0271
81.15101.0272

19388
81.15204.0199
85.15201.5021

19690
81.15204.5814

D0824 LFL
24/02 →

Mounting Parts

1.
00934
06.67042.0116
06.67049.0099

2.
19485
81.15502.5138
81.15502.5108

3.
00901
81.97420.0140
06.67041.0125
85.15640.0001

4.
00940
06.67041.0123
06.67042.0122
88.15640.2205

5.
00932
06.67042.0115

Horizontal
LHD
Standard

Series L2000

Type

Euro II/III



D0824 LFL
4 cyl.
81 KW/110 HP
114K W/155H P
118K W/160H P

D0824 FL
4 cyl.
75 KW/102 HP

L20
6-9t on.
05/93 →

L24
8-10 ton.
05/93 → 13/06

L33
6-9t on.
05/93 →

L35
9-10 ton.
07/93 → 13/06

Vertical
LHD
Standard

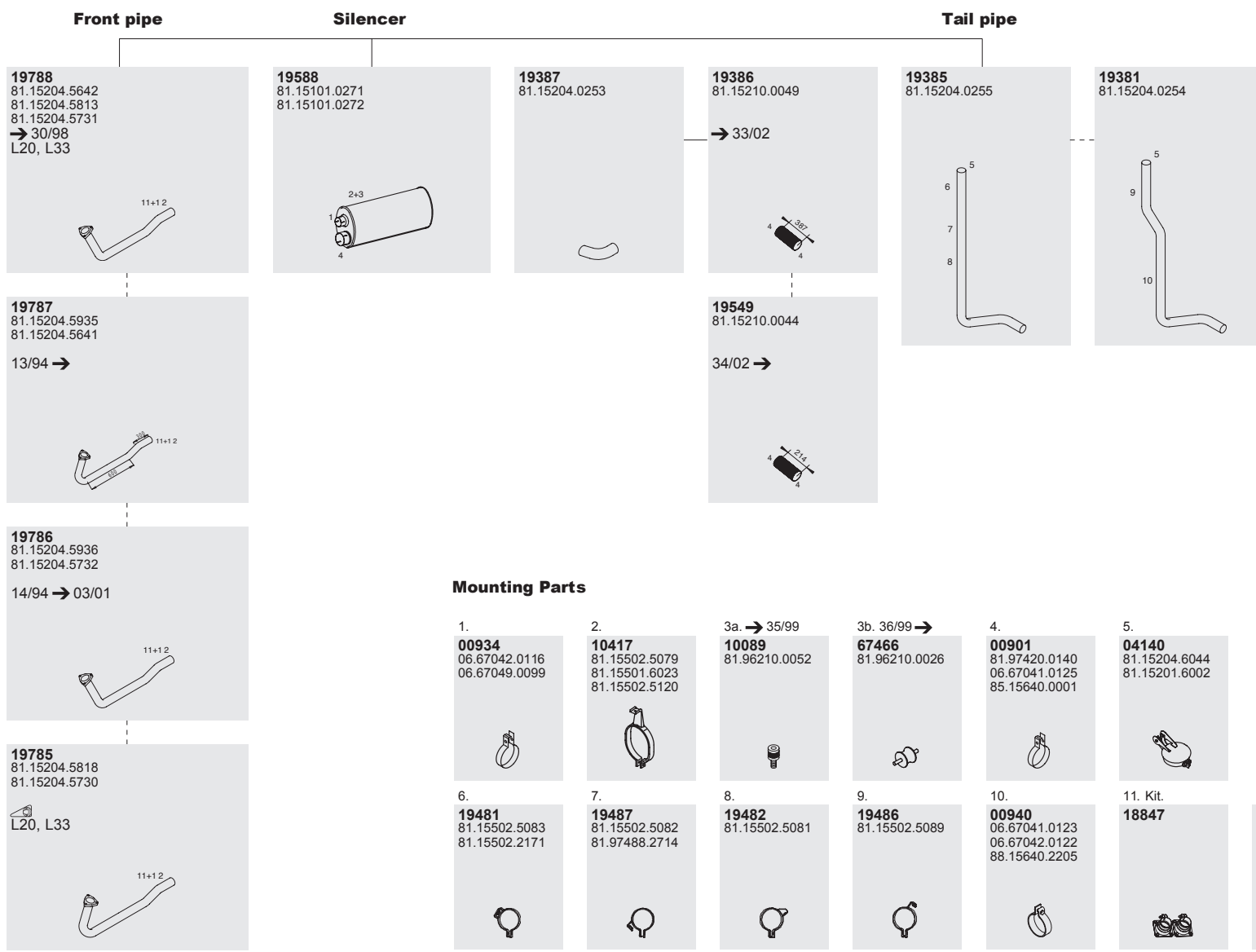

Series L2000

Type

Euro I/II



4 cyl.D 0824 LFL

L21
6-9t on.
07/93 →
F

L25
10 ton.
07/93 →
F

L34
8-9t on.
05/93 →
FL

L35
9-10 ton.
07/93 →
FL

L36
10 ton.
07/93 →
FL

Front pipe

19781
81.15204.5817
81.15204.5640

Ref.no. 81.15000.7469:
→ 13/94.
Ref.no. 208-049, 206-736:
28/94 → 04/95

19782
81.15204.5816
81.15204.5733

Ref.no. 81.15000.7469:
14/94 →
Ref.no. 206-737, 206-722:
28/94 → 04/95

Silencer

10559
81.15101.0250
81.15101.0238

19387
81.15204.0253

19386
81.15210.0049

Tail pipe

19385
81.15204.0255

Ref.no. 206-725
23/94 →

Mounting Parts

1.
00942
06.67041.0121
81.97420.0023
06.67041.0133

2.
10417
81.15502.5079
81.15501.6023
81.15502.5120

3a. → 35/99
10089
81.96210.0052

3b. 36/99 →
67466
81.96210.0026

4.
00901
81.97420.0140
06.67041.0125
85.15640.0001

5. Kit
18847

6. Cat. retrofit
18573

Vertical
LHD
Standard

Series L2000

Type

Euro II/III



✚ D0826 LFL
6 cyl.
162K W/220H P
188K W/255H P
191K W/260H P

✚ D0836 LFL
6 cyl.
162K W/220H P
180K W/245H P
206K W/280H P

L21
07/93 →

L25
07/93 → 13/06

Front pipeT

Silencer

ail pipe

19781
81.15204.5817
81.15204.5640
→ 12/04

19584
81.15101.0296
81.15101.0352

19987
81.15205.5001
WB 3350

19713
81.15204.5872
13/04 →

19972
81.15205.5002
WB 3650

19986
81.15205.5003
WB 3950

Mounting Parts

1.
00942
06.67041.0121
81.97420.0023
06.67041.0133

2.
10417
81.15502.5079
81.15501.6023
81.15502.5120

3a. → 35/99
10089
81.96210.0052

3b. 36/99 →
67466
81.96210.0026

4.
10062
88.15640.0005

5.
00988
06.67041.0124
06.67043.0124

Horizontal
LHD
Left

Series L2000

Type

Euro II

 4 cyl.D 0824 LFL

L22
8-9t on.
20/94 →

L26
10 ton.
24/94 →
LA

Horizontal
LHD
Standard

Front pipeT

Silencer

ail pipe

19787
81.15204.5935
81.15204.5641

L22
04/01 →

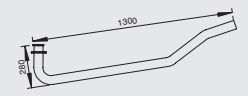

19588
81.15101.0271
81.15101.0272

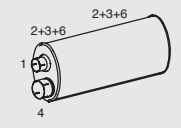

19383
81.15204.0269



19388
81.15204.0199
85.15201.5021

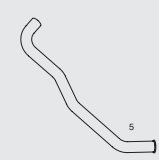

19786
81.15204.5936
81.15204.5732

L22
→ 03/01

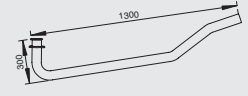

19380
81.15204.0279

8.153 FAE
WB 2910



19304
81.15204.0458

L26

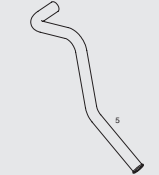

19789
81.15204.5737
81.15204.5738

8.153 FAE
WB 2910

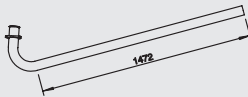





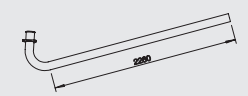

19644
81.15204.5950

L26



Mounting Parts

- | | | | | | | |
|---|---|---|---|---|---|---|
| 1. | 2. | 3. | 4. | 5. | 6. | 7. |
| 00934
06.67042.0116
06.67049.0099 | 10417
81.15502.5079
81.15501.6023
81.15502.5120 | 10089
81.96210.0052 | 00901
81.97420.0140
06.67041.0125
85.15640.0001 | 00940
06.67041.0123
06.67042.0122
88.15640.2205 | 10428
81.97488.0131 | 10427
81.97488.0129 |
|  |  |  |  |  |  |  |

Series L2000

Type

Euro II



D0826 LFL
6 cyl.
162K W/220H P

L23
8-9t on.
24/94 → 35/01

L27
10 ton.
24/94 →

Front pipe

Silencer

Tail pipe

19781
81.15204.5817
81.15204.5640

19780
81.15204.5739

10559
81.15101.0250
81.15101.0238

19383
81.15204.0269

19784
81.15204.5740

19608
81.15204.5873

19584
81.15101.0296
81.15101.0352

10956
81.15204.0393

19980
81.15204.0395

19713
81.15204.5872

Mounting Parts

1.
00942
06.67041.0121
81.97420.0023
06.67041.0133

2.
10417
81.15502.5079
81.15501.6023
81.15502.5120

3a. → 35/99
10089
81.96210.0052

3b. 36/99 →
67466
81.96210.0026

4.
10062
88.15640.0005

5.
00988
06.67041.0124
06.67043.0124

6.
10419
81.15501.0834

7.
00940
06.67041.0123
06.67042.0122
88.15640.2205

8.
00901
81.97420.0140
06.67041.0125
85.15640.0001

9.
10427
81.97488.0129

10.
10428
81.97488.0131

Horizontal
LHD
Standard

Series L2000

Type

Euro II/III



☞ D0826 LFL
6 cyl.
162K W/220H P
188K W/256H P
191K W/260H P

☞ D0836 LFL
6 cyl.
162K W/220H P
180K W/245H P
206K W/280H P

L21
8/9t on.
07/93 →

L25
10 ton.
07/93 → 13/06

L34
8/9t on.
05/93 →

L36
10 ton.
05/93 → 13/06

Horizontal
LHD
Left

Front pipe

19640
81.15204.5946

10634
81.15210.0056

19642
81.15204.0342

19648
81.15204.5809

☞ D0826 LFL

19647
81.15204.5836

Silencer

10559
81.15101.0250
81.15101.0238

☞ D0826 LFL

19587
81.15101.0291
81.15101.0289

☞ D0836 LFL

19584
81.15101.0296
81.15101.0352

10956
81.15204.0393

19/00 →

19388
81.15204.0199
85.15201.5021

☞ D0826 LFL10
→ 18/00

19984
85.15201.5024

Mounting Parts

1.
00942
06.67041.0121
81.97420.0023
06.67041.0133

2.
19485
81.15502.5138
81.15502.5108

3.
00940
06.67041.0123
06.67042.0122
88.15640.2205

4.
00988
06.67041.0124
06.67043.0124

5.
00901
81.97420.0140
06.67041.0125
85.15640.0001

Series L2000

Type

Euro II/III



D0826 LFL
6 cyl.
162K W/220H P

4X2
L21
8/9t on.
07/93 →

L25
10 ton.
07/93 → 13/06

L34
8/9t on.
05/93 →

L36
10 ton.
05/93 → 13/06

4X4
L23
8/9t on.
24/94 → 35/01

L27
10 ton.
24/94 →

Front pipe

Silencer

Tail pipe

19713
81.15204.5872
→ 12/04
Excl. L23,L27

19584
81.15101.0296
81.15101.0352

19988
81.98901.0021

10700
81.15210.0058

19975
81.15204.0413
4X2
Excl. L23,L27

19971
81.15204.0415
4X4
For L23,L27

19973
81.15204.0441
81.15204.0414

19608
81.15204.5873
13/04 →

Mounting Parts

1.
00942
06.67041.0121
81.97420.0023
06.67041.0133

2.
10417
81.15502.5079
81.15501.6023
81.15502.5120

3a. → 35/99
10089
81.96210.0052

3b. 36/99 →
67466
81.96210.0026

4.
00981
81.97420.2017
83.97420.0500

5.
00988
06.67041.0124
06.67043.0124

6.
04188
81.15204.6034
81.15204.6022
81.15204.5486

Vertical
LHD
Standard

Series L2000

Type

Euro III



☞ D0824 LFL
4 cyl.
114K W/155H P
118K W/160H P

L26
10 ton.
24/94 →
WB 3260

Front pipe

19699
81.15204.6083
81.15204.5822



10680
81.15210.0046



19646
81.15204.0431

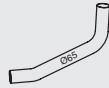

Silencer

19588
81.15101.0271
81.15101.0272



Tail pipe

19985
81.15204.0433



Mounting Parts

1.
00998
81.97401.0131
06.67041.0117
81.97420.0025



2.
00901
81.97420.0140
06.67041.0125
85.15640.0001



3.
04140
81.15204.6044
81.15201.6002



4.
00940
06.67041.0123
06.67042.0122
88.15640.2205



Vertical
LHD/RHD
Standard

Series L2000

Type

Euro II/III



D0826 LFL
6 cyl.
162K W/220H P

D0836 LFL
6 cyl.
162K W/220H P

L21
8/9t on.
07/93 →

L25
10 ton.
07/93 → 13/06

L34
8/9t on.
05/93 →

L36
10 ton.
05/93 → 13/06

Horizontal
LHD/RHD
Standard

Front pipe

Silencer

Tail pipe

19713
81.15204.5872

D0826 LFL

19584
81.15101.0296
81.15101.0352

10956
81.15204.0393

LHD

19976
81.15204.0439

D0826 LFL
LHD

19608
81.15204.5873

19978
81.15204.0392

RHD

19977
81.15204.0438

D0826 LFL
RHD

19737
81.15204.6068

D0826 LFL

Mounting Parts

1.
00942
06.67041.0121
81.97420.0023
06.67041.0133



2.
10417
81.15502.5079
81.15501.6023
81.15502.5120



3a. → 35/99
10089
81.96210.0052



3b. 36/99 →
67466
81.96210.0026



4.
00901
81.97420.0140
06.67041.0125
85.15640.0001



5.
00988
06.67041.0124
06.67043.0124



Series L2000

Type

Euro II

WB 3950

D0824 LFL
4 cyl.
104K W/141H P
114K W/155H P
118K W/160H P

D0834 LFL
4 cyl.
132k W/180H P

L22
8/9t on.
20/94 → 08/02

L26
10 ton.
24/94 →

Front pipe

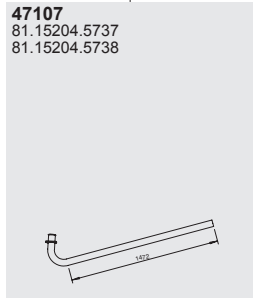

Silencer

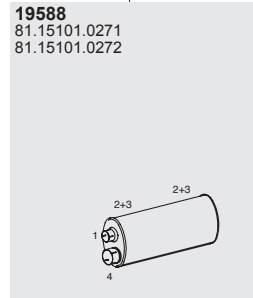

Tail pipe

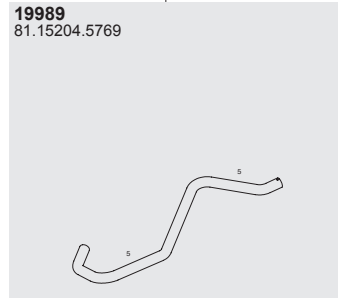

Mounting Parts

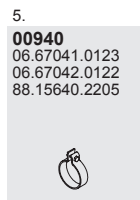
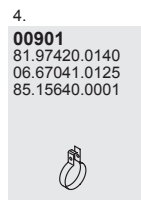
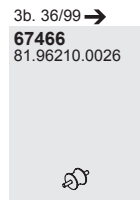
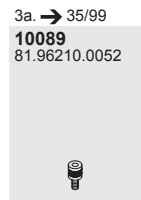
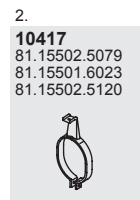

Horizontal
LHD
Standard

Series L2000

Type

Euro II/III



☞ D0824 LFL
4 cyl.
81 KW/110 HP
104K W/141H P
114K W/155H P
118K W/160H P

☞ D0824 FL
4 cyl.
75 KW/102 HP

☞ D0834 LFL
4 cyl.
103K W/140H P
132K W/180H P



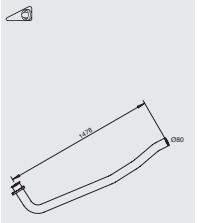
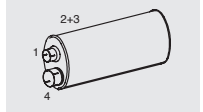
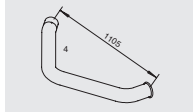

L20
6-9t on.
05/93 →

WB 5500

Front pipe Silencer Tail pipe

<p>19736 81.15204.6070 81.15204.6069</p> 	<p>19584 81.15101.0296 81.15101.0352</p> 	<p>19358 81.15204.0356 81.15204.0358</p> 
---	---	--

Mounting Parts

<p>1. 00942 06.67041.0121 81.97420.0023 06.67041.0133</p> 	<p>2. 10417 81.15502.5079 81.15501.6023 81.15502.5120</p> 	<p>3a. → 24/01 10089 81.96210.0052</p> 	<p>3b. 25/01 → 67466 81.96210.0026</p> 	<p>4. 00788 06.67041.0124 06.67043.0124</p> 
--	--	---	---	--

Horizontal
LHD/RHD
Standard

Series L2000

Type

Euro II/III



D0824 LFL
4 cyl.
114K W/155H P
118K W/160H P

L22
8/9t on.
20/94 → 08/02

L26
10 ton.
24/94 →

L41
10 ton.
06/04 →

Front pipe

Silencer

Tail pipe

19789
81.15204.5737
81.15204.5738

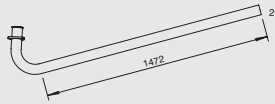

19588
81.15101.0271
81.15101.0272

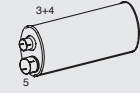

19643
81.15204.0289



19386
81.15210.0049



19389
81.15204.0279



Mounting Parts

1.
00940
06.67041.0123
06.67042.0122
88.15640.2205



2.
00934
06.67042.0116
06.67049.0099



3.
10417
81.15502.5079
81.15501.6023
81.15502.5120



4a. → 35/99
10089
81.96210.0052



4b. 36/99 →
67466
81.96210.0026



5.
00901
81.97420.0140
06.67041.0125
85.15640.0001



Vertical
LHD
Standard

Series M2000L

Type

Euro II/ III



D0824 LFL
4 cyl.
114K W/155H P

L70
11/12t on.
21/95 →
L

L72
11/12t on.
22/95 →
LL

Front pipe

Silencer

Tail pipe

19797
81.15204.6050
81.15204.6051

19588
81.15101.0271
81.15101.0272

19347
85.15201.5020

Short version
→ 20/96

19366
81.15204.0362
81.15204.0464

21/96 →
LHD

19362
81.15204.0363

21/96 →
RHD

19786
81.15204.5936
81.15204.5732

→ 03/01
LHD

19787
81.15204.5935
81.15204.5641

04/01 →
LHD

19388
81.15204.0199
85.15201.5021

LHD
LEFT

19606
81.15204.6077

SAE 2

19609
81.15204.6078

SAE 2

Mounting Parts

1.
00934
06.67042.0116
06.67049.0099

2a.
10417
81.15502.5079
81.15501.6023
81.15502.5120

2b.
19484
81.15501.5133
81.15501.5120

3a. → 24/01
10089
81.96210.0052

3b. 25/01 →
67466
81.96210.0026

4.
00901
81.97420.0140
06.67041.0125
85.15640.0001

5.
00940
06.67041.0123
06.67042.0122
88.15640.2205

6.
19476
81.15901.0038

Horizontal
LHD/RHD
Standard

Series M2000L

Type

Euro II

 D0826L FL 6 cyl.



L80
13/14 ton.
01/96 →
LA



L82
15 ton.
16/95 →
L

L84
15 ton.
30/95 →
LL

L86
18 ton.
10/95 →
L

L87
18 ton.
10/95 →
L

L88
18 ton.
19/95 →
LL

L89
18 ton.
34/95 →
LLL

L90
18 ton.
34/95 →
LA

Horizontal
LHD
Standard

Front pipeT

19736
81.15204.6070
81.15204.6069
→ 03/97

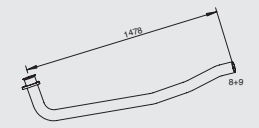

19732
81.15204.6056
04/97 →

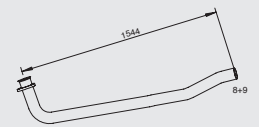

Silencer

19584
81.15101.0296
81.15101.0352

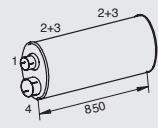

ail pipe

19363
81.15204.0349
81.15204.0449
L88, L 89 162K W
14/96 →

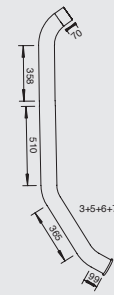

19351
81.15204.0389
L891 92 KW

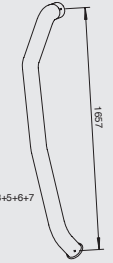

19352
81.15204.0325
L891 62 KW
→ 13/96

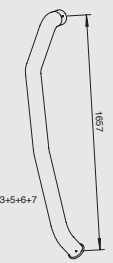

19353
81.15204.0402
L90



Mounting Parts

1.
00942
06.67041.0121
81.97420.0023
06.67041.0133



2.
10472
81.15501.5591



3.
10089
81.96210.0052



4.
00981
81.97420.2017
83.97420.0500



5.
00940
06.67041.0123
06.67042.0122
88.15640.2205



6.
10428
81.97488.0131



7.
10427
81.97488.0129



8. Kit
18847



9. Cat. retrofit
18573



Series M2000L

Type

Euro II

 D0826L FL 6 cyl.



L80
13/14 ton.
01/96 →
LA



L82
15 ton.
16/95 →
L

L84
15 ton.
30/95 →
LL

L86
18 ton.
10/95 →
L

L87
18 ton.
10/95 →
L

L88
18 ton.
19/95 →
LL

L89
18 ton.
34/95 →
LLL

L90
18 ton.
34/95 →
LA

Vertical
LHD
Standard

Front pipe

Silencer

Tail pipe

19736
81.15204.6070
81.15204.6069
→ 03/97



19584
81.15101.0296
81.15101.0352

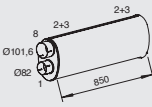

19356
85.15201.2007



10743
81.15210.0071



19355
85.15201.5005



19360
85.15201.5004



19732
81.15204.6056
04/97 →



Mounting Parts

1.
00942
06.67041.0121
81.97420.0023
06.67041.0133



2.
10472
81.15501.5591



3.
10089
81.96210.0052



4. Kit
18847



5. Cat. retrofit
18573



6.
00988
06.67041.0124
06.67043.0124



7.
04186



8.
00981
81.97420.2017
83.97420.0500



Series M2000L

Type

Euro II/III



D0824 LFL
4 cyl.
114K W/155H P

L62
13 ton.
WB 5000
05/97 → 17/01

L74
12/13/14 ton.
16/95 → 34/01
L

L76
12/13/14 ton.
28/95 → 34/01
LL

L81
14/15 ton.
27/95 → 13/05
L

L83
14/15 ton.
30/95 → 19/01
LL

Horizontal
LHD/RHD
Standard

Front pipe

Silencer

Tail pipe

19606
81.15204.6077

17/98 →
SAE2
Excl. L62

19609
81.15204.6078

17/98 →
SAE2
Excl. L62

19588
81.15101.0271
81.15101.0272

19347
85.15201.5020

Short version
→ 20/96
Excl. L62

10974
81.15204.0365

21/96 →
LHD
Excl. L62

10968
81.15204.0366

21/96 →
RHD

19787
81.15204.5935
81.15204.5641

32/95 →
Excl. L62

19366
81.15204.0362
81.15204.0464

17/98 →
SAE2
LHD
Excl. L62

19362
81.15204.0363

17/98 →
SAE2
RHD
Excl. L62

19797
81.15204.6050
81.15204.6051

33/95 →

Mounting Parts

1.
00934
06.67042.0116
06.67049.0099

2a.
10417
81.15502.5079
81.15501.6023
81.15502.5120

2b.
19484
81.15501.5133
81.15501.5120

3a. → 24/01
10089
81.96210.0052

3b. 25/01 →
67466
81.96210.0026

4.
00901
81.97420.0140
06.67041.0125
85.15640.0001

5.
00940
06.67041.0123
06.67042.0122
88.15640.2205

6.
19476
81.15901.0038

Series M2000L

Type

Euro II/III



☞ D0826 LFL
6 cyl.
162K W/220H P

☞ D0836 LFL
6 cyl.
206K W/280H P

L95
26 ton.
04/99 →
DL

Front pipe

19736
81.15204.6070
81.15204.6069

Silencer

19587
81.15101.0291
81.15101.0289

206K W

Tail pipe

19358
81.15204.0356
81.15204.0358

RHD

19684
81.15101.0296
81.15101.0352

162K W

19363
81.15204.0349
81.15204.0449

LHD

Mounting Parts

1.
00942
06.67041.0121
81.97420.0023
06.67041.0133

2.
19477
85.15502.5007

3a. → 24/01
10089
81.96210.0052

3b. 25/01 →
67466
81.96210.0026

4.
10062
88.15640.0005

5.
00988
06.67041.0124
06.67043.0124

Horizontal
LHD/RHD
Standard

Series M2000L

Type

Euro II/III



D0826 LF
6 cyl.
162K W/220H P
191K W/260H P

L79
12/13/14 ton.
04/96 →
LLL

L86
14/15/20 ton.
01/96 →
LLL

L89
18 ton.
34/95 →
LLL

Front pipe

19726
81.15204.5892
81.15204.5842

191K W
→ 36/04
17/05 →

19600
85.15201.6002
81.15204.6065

19607
81.15204.5893
81.15204.5843

162K W
191K W 37/04 → 16/05

Silencer

19587
81.15101.0291
81.15101.0289

191K W
162K W → 03/97

19584
81.15101.0296
81.15101.0352

162K W
04/97 →

Tail pipe

19358
81.15204.0356
81.15204.0358

RHD

19363
81.15204.0349
81.15204.0449

LHD

Mounting Parts

1.
00942
06.67041.0121
81.97420.0023
06.67041.0133

2.
10417
81.15502.5079
81.15501.6023
81.15502.5120

3a. → 24/01
10089
81.96210.0052

3b. 25/01 →
67466
81.96210.0026

4.
10062
88.15640.0005

5.
00988
06.67041.0124
06.67043.0124

Horizontal
LHD/RHD
Standard

Series M2000L

Type

Euro II/III



D0826 LFL
6 cyl.
162K W/220H P
191K W/260H P

D0836 LFL
6 cyl.
206K W/280H P

L79
12/13/14 ton.
04/96 →
LLL

L86
14/15/20 ton.
01/96 →
LLL

L89
18 ton.
34/95 →
LLL

Front pipe

19726
81.15204.5892
81.15204.5842

191/206K W
→ 36/04
17/05 →

19776
81.15204.6021

10634
81.15210.0056

Intarder

19602
81.15204.0390

Intarder

19607
81.15204.5893
81.15204.5843

162K W

For 191/206K W
37/04 → 16/05

19777
81.15210.0022

19603
81.15204.0478

Silencer

19587
81.15101.0291
81.15101.0289

19584
81.15101.0296
81.15101.0352

Tail pipe

19962
85.15201.5017
81.15204.5981

19363
81.15204.0349
81.15204.0449

Intarder

19965
81.15204.5939

Mounting Parts

1.
00942
06.67041.0121
81.97420.0023
06.67041.0133

2.
19483
81.15501.6030
81.15501.6028

3.
10062
88.15640.0005

4.
00988
06.67041.0124
06.67043.0124

Horizontal
LHD
Standard

Series M2000L

Type

Euro II/III



D0824 LFL
4 cyl.
114K W/155H P

L74
12/13 ton.
16/95 → 34/01

L76
12/13/14 ton.
28/95 → 34/01

L81
14/15 ton.
27/95 → 13/05

L83
14/15 ton.
30/95 → 19/01

Front pipe

19787
81.15204.5935
81.15204.5641

→ 32/95

19797
81.15204.6050
81.15204.6051

→ 33/95

19606
81.15204.6077

17/98 →
SAE2

19609
81.15204.6078

17/98 →
SAE2

Silencer

19588
81.15101.0271
81.15101.0272

19979
85.15201.5001

10743
81.15210.0071

Tail pipe

19360
85.15201.5004

Left

Mounting Parts

1.
00934
06.67042.0116
06.67049.0099

2.
19484
81.15501.5133
81.15501.5120

3a. → 24/01
10089
81.96210.0052

3b. 25/01 →
67466
81.96210.0026

4.
00940
06.67041.0123
06.67042.0122
88.15640.2205

5.
00981
81.97420.2017
83.97420.0500

6. → 28.96.
04188
81.15204.6034
81.15204.6022
81.15204.5486

7.
00988
06.67041.0124
06.67043.0124

8.
19476
81.15901.0038

9.
00901
81.97420.0140
06.67041.0125
88.15640.0001

Vertical
LHD/RHD
Left

Series M2000L

Type

Euro I/II



D0824 LFL
4 cyl.
114K W/155H P

L70
11/12t on.
21/95 →
L

L72
11/12t on.
22/95 →
LL

Front pipe

19786
81.15204.5936
81.15204.5732
→ 03/01

19787
81.15204.5935
81.15204.5641
04/01 →

Silencer

19588
81.15101.0271
81.15101.0272

19387
81.15204.0253

19386
81.15210.0049

Tail pipe

19385
81.15204.0255

Mounting Parts

1.
00934
06.67042.0116
06.67049.0099

2.
10417
81.15502.5079
81.15501.6023
81.15502.5120

3a. → 24/01
10089
81.96210.0052

3b. 25/01 →
67466
81.96210.0026

4.
00901
81.97420.0140
06.67041.0125
85.15640.0001

5.
19482
81.15502.5081

6.
19487
81.15502.5082
81.97488.2714

7.
19481
81.15502.5083
81.15502.2171

8.
04140
81.15204.6044
81.15201.6002

Vertical
LHD
Standard

Series M2000M

Type

Euro II/III



 12/13/14/18/23
 25/26 ton.

 D0826 LF
 6 cyl.
 162K W/220H P
 191K W/260H P

 D0836 LF
 6 cyl.
 206K W/280H P

M31
 24/95 → 34/01
 M

M32
 28/95 → 31/05
 ML

M33
 04/96 → 31/05
 MLL

M38
 10/95 → 31/05
 M

M39
 16/95 → 31/05
 ML

M40
 34/95 → 31/05
 MLL

M42
 22/95 → 31/05
 MNL

M43
 01/96 → 01/02
 MNLL

M44
 04/96 → 09/04
 MVL

Horizontal
 LHD
 Standard

Front pipe

19647
 81.15204.5836



10634
 81.15210.0056



14684
 81.15204.0371

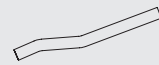

Silencer

19587
 81.15101.0291
 81.15101.0289

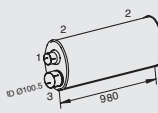

Tail pipe

19378
 81.15204.0348
 81.15204.0350
 81.15204.0459



19974
 81.15204.5937



Excl.M 33,M40,M43
 37/98 →

14680
 81.15204.0477

162K W
 Excl.M 33,M40,M43



19584
 81.15101.0296
 81.15101.0352

 D0826 LF
 162K W
 Excl.M 33,M40,M43

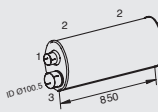

19968
 85.15201.5018

162K W
 Excl.M 33,M40,M43

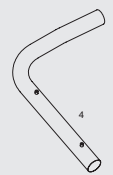

Mounting Parts

1.
00942
 06.67041.0121
 81.97420.0023
 06.67041.0133



2.
19483
 81.15501.6030
 81.15501.6028



3.
10062
 88.15640.0005



4.
00988
 06.67041.0124
 06.67043.0124



Series M2000M

Type

Euro II/III



D0826 LF
6 cyl.
162K W/220H P
191K W/260H P

D0836 LF
6 cyl.
206K W/280H P

M33
12/13/14 ton.
04/96 → 31/05
MLL

M40
18 ton.
34/95 → 31/05
MLL

M43
25 ton.
01/96. → 01/02
MNLL

Front pipe

19726
81.15204.5892
81.15204.5842

191K W, 206 KW
→ 36/04
17/05 →

19776
81.15204.6021

10634
81.15210.0056

Intarder

19602
81.15204.0390

Intarder

19587
81.15101.0291
81.15101.0289

19378
81.15204.0348
81.15204.0350
81.15204.0459

Intarder
→ 36/98

19363
81.15204.0349
81.15204.0449

Intarder
37/98 →

19607
81.15204.5893
81.15204.5843

162K W
For 1 91 KW, 206 KW
37/04 → 16/05

19777
81.15210.0022

162K W

19603
81.15204.0478

162K W

19584
81.15101.0296
81.15101.0352

162K W

19968
85.15201.5018

162K W

19974
81.15204.5937

37/98 → 16/00

Mounting Parts

1.
00942
06.67041.0121
81.97420.0023
06.67041.0133

2.
19483
81.15501.6030
81.15501.6028

3.
10062
88.15640.0005

4.
00988
06.67041.0124
06.67043.0124

Horizontal
LHD
Standard

Series M2000M

Type

Euro II/III



D0826 LF
6 cyl.
162K W/220H P
191K W/260H P

D0836 LF
6 cyl.
206K W/280H P

M33
12/13/14 ton.
04/96 → 31/05
MLL

M40
18 ton.
34/95 → 31/05
MLL

M43
25 ton.
01/96 → 01/02
MNLL

Front pipe

19726
81.15204.5892
81.15204.5842

191/206K W
→ 36/04
17/05 →

19601
81.15204.6064

19605
81.15210.0019
81.15210.0011

19604
81.15204.0376

19587
81.15101.0291
81.15101.0289

19967
81.15204.0345

19607
81.15204.5893
81.15204.5843

162K W
For 191/206K W 37/04 →
16/05

Mounting Parts

1.
00942
06.67041.0121
81.97420.0023
06.67041.0133

2.
19489
81.15502.5121

3.
10062
88.15640.0005

4.
00988
06.67041.0124
06.67043.0124

5.
04188
81.15204.6034
81.15204.6022
81.15204.5486

Vertical
LHD/RHD
Standard

Series M2000M

Type

Euro II/III



∅ D0826 LF
6 cyl.
162K W/220H P
191K W/260 HP

∅ D0836 LF
6 cyl.
206K W/280H P

M33
12/13/14 ton.
04/96 → 31/05
MLL

M40
18 ton.
34/95 → 31/05
MLL

M43
25 ton.
01/96 → 01/02
MNLL

Front pipe

19726
81.15204.5892
81.15204.5842

191/206K W
→ 36/04
17/05 →

19600
85.15201.6002
81.15204.6065

19607
81.15204.5893
81.15204.5843

162K W
For 191/206K W
37/04. → 16/05

Silencer

19587
81.15101.0291
81.15101.0289

∅ D0826/0836 LF
162K W, → 03/97

19584
81.15101.0296
81.15101.0352

∅ D0826 LF
162K W
04/97 →

Tail pipe

19378
81.15204.0348
81.15204.0350
81.15204.0459

∅ D0826 LF
→ 14/02
LHD

19970
81.15204.0440

∅ D0826 LF
15/02 →
LHD

19367
81.15204.0355
81.15204.0357

∅ D0826 LF
RHD

19348
85.15201.5019

∅ D0836 LF
RHD

Mounting Parts

1.
00942
06.67041.0121
81.97420.0023
06.67041.0133

2.
10417
81.15502.5079
81.15501.6023
81.15502.5120

3a. → 24/01
10089
81.96210.0052

3b. 25/01 →
67466
81.96210.0026

4.
10062
88.15640.0005

5.
00988
06.67041.0124
06.67043.0124

Horizontal
LHD/RHD
Standard

Series M2000M

Type

Euro II/III

 D0826L F
 6 cyl.
 162K W/220H P
 191K W/260H P

12-14 ton.
M31
 24/95 → 34/01
 M
M32
 28/95 → 31/05
 ML
M33
 04/96 → 31/05
 MLL
M34
 34/95 → 31/05
 MA

18 ton.
M38
 10/95 → 31/05
 M
M39
 16/95 → 31/05
 ML
M40
 34/95 → 31/05
 MLL
M41
 01/96 → 31/05
 MA

23/25 ton.
M42
 22/95 → 31/05
 MNL

25 ton.
M43
 01/96 → 01/02
 MNLL

25/26 ton.
M44
 04/96 → 09/04
 MVL

Horizontal
 LHD
 Standard

Front pipe

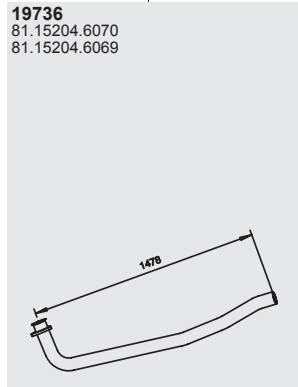

Silencer

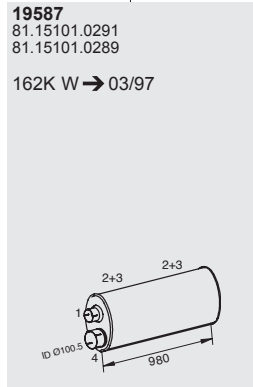

Tail pipe

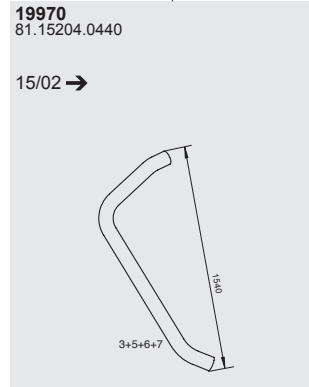
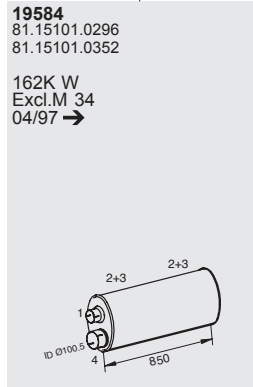
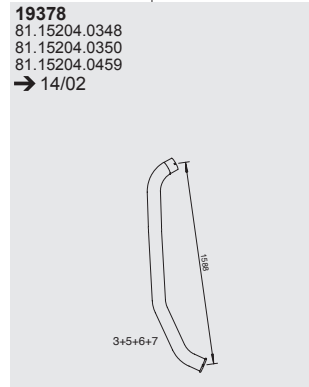

Mounting Parts

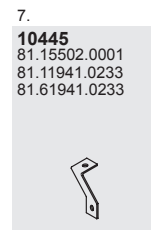
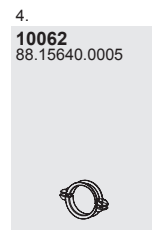
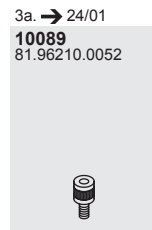

Series M2000M

Type

Euro II/III

☞ D0836L F
6 cyl.
206K W/280H P

M31
12/13/14 ton.
24/95 → 34/01
M

M32
12/13/14 ton.
28/95 → 31/05
ML

M38
18 ton.
10/95 → 31/05
M

M39
18 ton.
16/95 → 31/05
ML

M42
23/25 ton.
22/95. → 31/05
MNL

Front pipeT

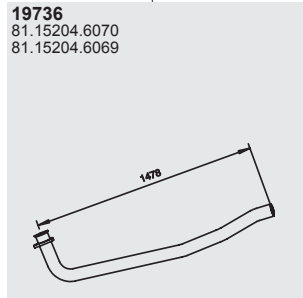

Silencer

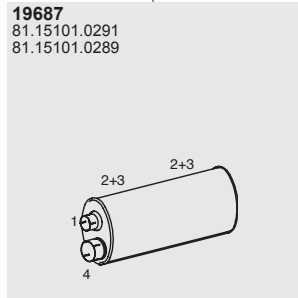

ail pipe

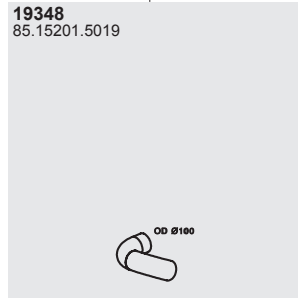

Mounting Parts

1.
00942
06.67041.0121
81.97420.0023
06.67041.0133



2.
10417
81.15502.5079
81.15501.6023
81.15502.5120



3a. → 24/01
10089
81.96210.0052



3b. 25/01 →
67466
81.96210.0026



4.
10062
88.15640.0005



Horizontal
LHD/RHD
Standard

Series F2000

Type

Euro II/ III



D2866 LF
6 cyl.
294K W/400H P

D2876
6 cyl.
338K W/460H P

T45
35 ton.
16/95 → 11/03
VF

Front pipe

10643
81.15204.0250

10649
81.15204.5724
81.15204.5940

10755
81.15210.0054

19735
81.15204.5887
81.15204.5841

19745
81.15210.0084

14777
81.15204.5900

Silencer

10533
81.15101.0285
81.15101.0316
81.15101.0318

Tail pipe

10302
81.15204.0252

Mounting Parts

1.
00971
81.97420.0085
88.15640.2203
81.97420.0152

2.
00978
88.15640.0000
81.97420.0073

3.
10411
81.15110.0297
81.15110.0357

4.
10415
81.15110.0299

5.
10467
81.97460.6021

Horizontal
LHD
Left

Series F2000

Type

Euro II/ III



D2866 LF
6 cyl.
272K W/370H P
294K W/400H P
309K W/420H P

D2876 LF
6 cyl.
338K W/460H P

T34
18 ton.
33/94 → 07/05
FA

T38
26 ton.
30/94 → 07/05
FVL

T42
27/33 ton.
36/94 → 07/05
DFA

Front pipe

10643
81.15204.0250

10649
81.15204.5724
81.15204.5940

10755
81.15210.0054
→ 20/99.

10647
81.15204.0261
→ 20/99

19733
81.15204.5757
Allw heeld rive
T34,T42

10646
81.15204.0251
→ 20/99
T42

10711
81.15204.0277
D2866LF
→ 20/99
T38

19745
81.15210.0084
21/99 →

10669
81.15204.0416
21/99. →

10659
81.15204.0417
21/99 →
T42

14780
81.15204.0418
D2866LF
21/99 →
T38

Silencer

10533
81.15101.0285
81.15101.0316
81.15101.0318

Tail pipe

10302
81.15204.0252

Mounting Parts

1.
00978
88.15640.0000
81.97420.0073

2.
00971
81.97420.0085
88.15640.2203
81.97420.0152

3.
10416
81.97488.0100

4.
10078
81.96210.0153
81.96210.0127
81.96210.0602

5.
10411
81.15110.0297
81.15110.0357

6.
10415
81.15110.0299

7.
10467
81.97460.6021

Horizontal
LHD
Left

Series F2000

Type

Euro II/ III



D2866 LF
6 cyl.
294K W/ 400H P



D2876 LF
6 cyl.
338K W/ 460H P

T44
40 ton.
19/97 → 07/05
DFA

Front pipe

10643
81.15204.0250



10649
81.15204.5724
81.15204.5940



10755
81.15210.0054



19733
81.15204.5757

Allw heeld rive

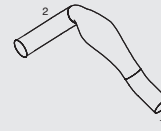

19745
81.15210.0084



14784
81.15204.5898

D2866 LF
Allw heeld rive

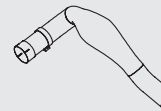

Silencer

10533
81.15101.0285
81.15101.0316
81.15101.0318

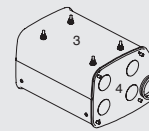

Tail pipe

10302
81.15204.0252



Mounting Parts

1.
00971
81.97420.0085
88.15640.2203
81.97420.0152



2.
00978
88.15640.0000
81.97420.0073



3.
10411
81.15110.0297
81.15110.0357



4. → 03/98
10415
81.15110.0299



5.
10467
81.97460.6021



Horizontal
LHD
Standard

Series F2000

Type

Euro II/III



⌀ D2866 LF
6 cyl.
228K W/310H P
265K W/360H P
272K W/370H P
294K W/400H P
301K W/409H P
309K W/420H P

⌀ D2876 LF
6 cyl.
338K W/460H P

T31
18 ton.
16/94 → 07/05
F

T32
18 ton.
14/94 → 07/05
FL

T50
19 ton.
01/96 → 02/03
FLL

T33
18/19 ton.
17/94 → 19/02
FLL

T35
23 ton.
17/94 → 09/04
FNLL

T36
26 ton.
21/94 → 07/05
FNL

Horizontal
LHD
Left

Front pipe

10643
81.15204.0250

10649
81.15204.5724
81.15204.5940

10755
81.15210.0054

→ 20/99

10647
81.15204.0261

→ 20/99

10646
81.15204.0251

→ 20/99
T31, T32, T50

19745
81.15210.0084

21/99 →

10669
81.15204.0416

21/99 →

10659
81.15204.0417

21/99 →
T31, T32, T50

Silencer

10533
81.15101.0285
81.15101.0316
81.15101.0318
Incl.

Tail pipe

10302
81.15204.0252

Mounting Parts

1.
00978
88.15640.0000
81.97420.0073

2.
00971
81.97420.0085
88.15640.2203
81.97420.0152

3. → 20.99.
10416
81.97488.0100

4.
10078
81.96210.0153
81.96210.0127
81.96210.0602

5.
10411
81.15110.0297
81.15110.0357

6.
10415
81.15110.0299

7.
10467
81.97460.6021

Series F2000

Type

Euro II/ III



D2866 LF
6 cyl.
272K W/370H P
294K W/400H P
309K W/420H P

D2876 LF
6 cyl.
338K W/460H P

T37
26 ton.
14/94 → 36/04
FNL

T39
26/27/28 ton.
27/94 → 12/01
DF

T40
26 ton.
07/95 → 09/04
DFL

T43
40 ton.
07/97 → 07/05
DF

T48
26/33 ton.
33/94 → 07/05
DF

Horizontal
LHD
Left

Front pipe

10643
81.15204.0250

10649
81.15204.5724
81.15204.5940

10755
81.15210.0054
→ 20/99

10647
81.15204.0261
→ 20/99

10646
81.15204.0251
→ 20/99
T39, T40

19745
81.15210.0084
21/99 →

10669
81.15204.0416
21/99 →

10659
81.15204.0417
21/99 →
T39, T40, T48

Silencer

10533
81.15101.0285
81.15101.0316
81.15101.0318

Tail pipe

10302
81.15204.0252

Mounting Parts

1.
00978
88.15640.0000
81.97420.0073

2.
00971
81.97420.0085
88.15640.2203
81.97420.0152

3. → 20.99.
10416
81.97488.0100

4.
10078
81.96210.0153
81.96210.0127
81.96210.0602

5.
10411
81.15110.0297
81.15110.0357

6.
10415
81.15110.0299

7.
10467
81.97460.6021

Series F2000

Type

Euro II/III



D2866 LF
6 cyl.
272K W/370H P
294K W/400H P
309K W/420H P

D2876 LF
6 cyl.
338K W/460H P

T34
18 ton.
33/94 → 07/05
FA

T39
26/27/28 ton.
27/94 → 12/01
DF

T40
26 ton.
07/95 → 09/04
DFL

T42
26/33 ton.
36/94 → 07/05
DFA

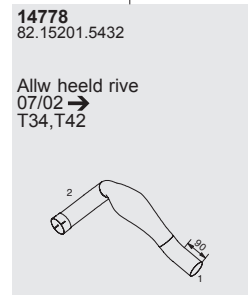
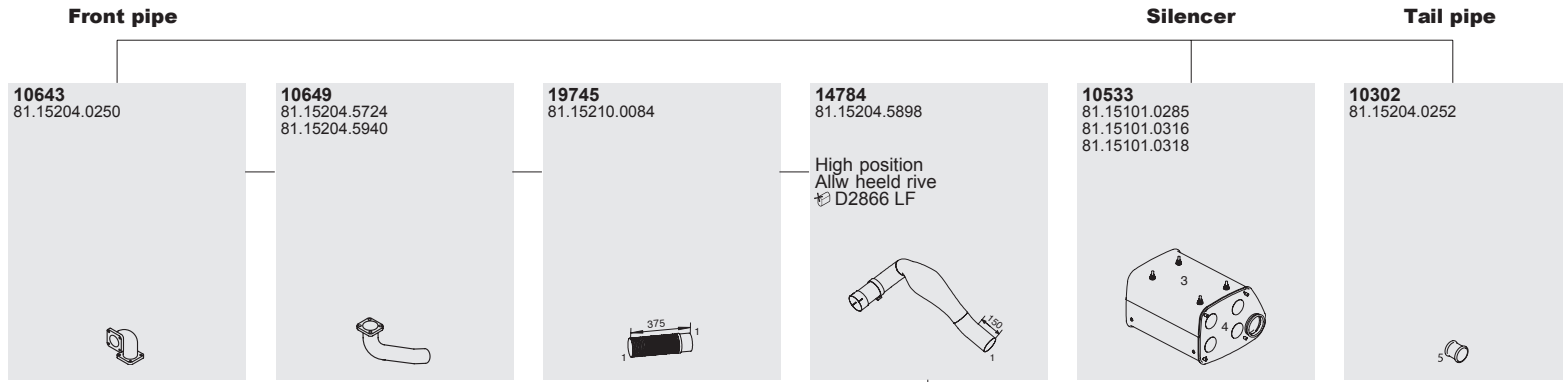

Mounting Parts

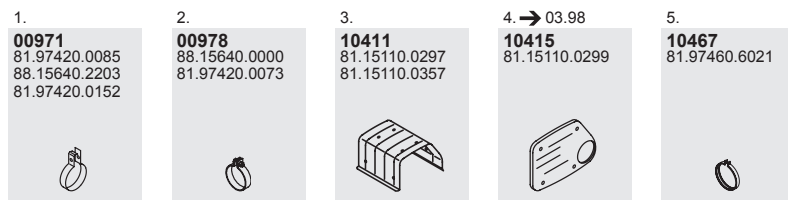

Horizontal
LHD
Standard

Series F2000

Type

Euro I/II



∅ D2865 LF
5 cyl.
213K W/290H P
235K W/320H P
250K W/340H P



T07
24/26/27 ton.
14/94 → 01/00
FNLL



T20
19 ton.
01/96 → 01/00
FLL

Horizontal
LHD
Left

Front pipe

10734
81.15204.5691
81.15204.5667

→ 36/98

10645
81.15204.5750

29/94 → 06/96

10641
81.15204.5749

29/94 → 06/96

10755
81.15210.0054

10647
81.15204.0261

10533
81.15101.0285
81.15101.0316
81.15101.0318

10302
81.15204.0252

10690
81.15204.5717

Euro 2

19795
81.15204.5782

07/96 →

10648
81.15204.5751
81.15204.5734

T07

10646
81.15204.0251

16S-151 +
Intarder

10747
81.15204.5664
82.15201.5372

aut.

19758
81.15210.0078
82.99282.8086

aut.

Silencer

Tail pipe

Mounting Parts

1.
00978
88.15640.0000
81.97420.0073

2.
00971
81.97420.0085
88.15640.2203
81.97420.0152

3.
10416
81.97488.0100

4.
10078
81.96210.0153
81.96210.0127
81.96210.0602

5.
10411
81.15110.0297
81.15110.0357

6.
10415
81.15110.0299

7.
10467
81.97460.6021

8. → 06.96.
00901
81.97420.0140
06.67041.0125
85.15640.0001

Series F2000

Type

Euro I/II



D2865 LF
5 cyl.
198K W/269H P
213K W/290H P
235K W/320H P
250K W/340H P

T01
18/19 ton.
4X2
13/94 → 34/99
F

T02
18/19 ton.
13/94 → 01/00
FL

T03
18/19 ton.
4X2
15/94 → 01/00.
FLL

T04
19/21 ton.
4X4
33/94 → 01/00
FA

T05
23/24/27 ton.
6X2, 6X4
17/94 → 01/00
FNLL

Horizontal
LHD
Left

Front pipe

10734
81.15204.5691
81.15204.5667

10648
81.15204.5751
81.15204.5734

10690
81.15204.5717

Euro 2

19795
81.15204.5782

07/96 →
T03, T05

10650
81.15204.5665

T01, T02

10645
81.15204.5750

29/94 → 06/96
T03, T05

10641
81.15204.5749

29/94 → 06/96
T03, T05

Mounting Parts

1.
00978
88.15640.0000
81.97420.0073

2.
00971
81.97420.0085
88.15640.2203
81.97420.0152

3.
10416
81.97488.0100

4.
10078
81.96210.0153
81.96210.0127
81.96210.0602

10755
81.15210.0054

10647
81.15204.0261

10646
81.15204.0251

Z F 16S-151 +I ntarder
Excl.T04

19733
81.15204.5757

T04

10711
81.15204.0277

T02

Silencer

10533
81.15101.0285
81.15101.0316
81.15101.0318

Tail pipe

10302
81.15204.0252

7.
10467
81.97460.6021

8. → 06.96.
00901
81.97420.0140
06.67041.0125
85.15640.0001

5.
10411
81.15110.0297
81.15110.0357

6.
10415
81.15110.0299

Series F2000

Type

Euro I/II



D2865 LF
5 cyl.
198K W/269H P
213K W/290H P
235K W/320H P
250K W/340H P

T06
24/26/27 ton.
Emission icons
20/94 → 01/00
FNL

T08
24/26-28 ton.
Emission icons
30/94 → 01/00
FVL

T09
26/27 ton
Emission icons
27/94 → 01/00
DF

T10
26/27 ton.
Emission icons
07.95 → 01.00.
DFL

T12
26/27/28 ton.
Emission icons
36/94 → 01/00
DFA

T18
26/27/28 ton.
Emission icons
33/94 → 01/00
DF

Horizontal
LHD
Left

Front pipe

10734
81.15204.5691
81.15204.5667

10648
81.15204.5751
81.15204.5734

10755
81.15210.0054

10690
81.15204.5717

Euro 2

10747
81.15204.5664
82.15201.5372

aut.
Excl. T12

19758
81.15210.0078
82.99282.8086

aut.
Excl. T12

Silencer

10711
81.15204.0277

T06, T08

10533
81.15101.0285
81.15101.0316
81.15101.0318

19733
81.15204.5757

T12

10647
81.15204.0261

10646
81.15204.0251

16S-151+ Intarder
Excl. T12

Tail pipe

10302
81.15204.0252

Mounting Parts

1.
00978
88.15640.0000
81.97420.0073

2.
00971
81.97420.0085
88.15640.2203
81.97420.0152

3.
10416
81.97488.0100

4.
10078
81.96210.0153
81.96210.0127
81.96210.0602

5.
10411
81.15110.0297
81.15110.0357

6.
10415
81.15110.0299

7.
10467
81.97460.6021

Series F2000

Type

Euro I/II



D2866 LF
6 cyl.
272K W/370H P
294K W/400H P
309K W/420H P

T08
22/26-28 ton.
30/94 → 01/00
FVL

Front pipe

10643
81.15204.0250

10649
81.15204.5724
81.15204.5940

10755
81.15210.0054

→ 20/99

10711
81.15204.0277

→ 20/99

19745
81.15210.0084

21/99 →

14780
81.15204.0418

21/99 →

Silencer

10533
81.15101.0285
81.15101.0316
81.15101.0318

Tail pipe

10302
81.15204.0252

Mounting Parts

1.
00971
81.97420.0085
88.15640.2203
81.97420.0152

2.
00978
88.15640.0000
81.97420.0073

3.
10415
81.15110.0299

4.
10411
81.15110.0297
81.15110.0357

5.
10467
81.97460.6021

Horizontal
LHD
Standard

Series F2000

Type

Euro I/II



D2865 LF
5 cyl.
213K W/290H P
250K W/340H P

T15
32/35 ton.
18/95 → 01/00
VF

T16
35/37/41 ton.
19/95 → 01/00
VF

Front pipe

10734
81.15204.5691
81.15204.5667

10648
81.15204.5751
81.15204.5734

10755
81.15210.0054

19735
81.15204.5887
81.15204.5841

10690
81.15204.5717

Euro 2
→ 36/98

Silencer

10533
81.15101.0285
81.15101.0316
81.15101.0318

Tail pipe

10302
81.15204.0252

Mounting Parts

1.
00971
81.97420.0085
88.15640.2203
81.97420.0152

2.
00978
88.15640.0000
81.97420.0073

3.
10411
81.15110.0297
81.15110.0357

4.
10415
81.15110.0299

5.
10467
81.97460.6021

Horizontal
LHD
Standard

Series F2000

Type

Euro I/II



D2865 LF 5 cyl.
 198K W/269H P
 213K W/290H P
 235K W/320H P
 250K W/340H P

18/19 ton.

T01 F
 13/94 → 34/99
T02 FL
 13/94 → 01/00
T03 FLL
 15/94 → 01/00

T04 FA
 19/21 ton.

 33/94 → 01/00

T05 FNLL
 23/24/27 ton.

 17/94 → 01/00

24/26/27 ton.

T06 FNL
 20/94 → 01/00
T07 FNLL
 14/94 → 01/00

T20 FLL
 19 ton.

 01/96 → 01/00

Vertical
LHD
Right

Front pipe

10759
81.15204.5420

19758
81.15210.0078
82.99282.8086

19757
81.15204.0178
82.15201.0042

Silencer

10592
81.15101.0288
81.15101.0340

Tail pipe

19966
81.15204.5840

Excl. T20

Mounting Parts

1.
00971
81.97420.0085
88.15640.2203
81.97420.0152

2.
00958
81.97401.0731
81.97420.0156

3.
04169
81.15204.6054

4.
10447
88.15640.0007

Series F2000

Type

Euro I/II



D2865 LF 5 cyl.
 198K W/269H P
 213K W/290H P
 235K W/320H P
 250K W/340H P

T08 FVL
 22/26-28 ton.
 ⑥X②/④
 30/94 → 01/00

26/27 ton.
 ⑥X④

T09 DF
 27/94 → 01/00

T10 DFL
 07/95 → 01/00

T12 DFA
 26/27/33t on.
 ⑥X⑥
 36/94 → 01/00

T15 VF
 32/35 ton.
 ⑥X④
 18/95 → 01/00

T16 VF
 35/37/41t on.
 ⑥X④
 19/95 → 01/00

T18 DF
 26/27/33t on.
 ⑥X④
 33/94 → 01/00

Vertical
 LHD
 Right

Front pipe

10759
81.15204.5420

19758
81.15210.0078
82.99282.8086

19757
81.15204.0178
82.15201.0042

Silencer

10592
81.15101.0288
81.15101.0340

Tail pipe

19966
81.15204.5840

Mounting Parts

1.
00971
81.97420.0085
88.15640.2203
81.97420.0152

2.
00958
81.97401.0731
81.97420.0156

3.
04169
81.15204.6054

4.
19447
88.15640.0007

Series F2000

Type

Euro II/III



⊕ D2866 LF 6 cyl.
272K W/370H P
294K W/400H P
309K W/420H P

⊕ D2876LF6 cyl.
338K W/460H P

T42 DFA
26/33 ton.
⊕ X 4
36/94 → 07/05

T43 DF
40 ton.
⊕ X 4
07/97 → 07/05

T45 VF
35 ton.
⊕ X 4
16/95 → 11/03

T46 VF
41 ton.
⊕ X 4
19/95 → 07/05.

T48 DF
26/33 ton.
⊕ X 4
33/94 → 07/05

Vertical
LHD
Standard

Front pipe

10759
81.15204.5420

19758
81.15210.0078
82.99282.8086

RH 330mm → 07/02

19757
81.15204.0178
82.15201.0042

⊕ D2866LF

14675
81.15210.0085

RH 330mm 08/02 →

14673
82.15201.5428
82.15201.5418

RH 330mm
T46

14671
81.15204.5905

Silencer

10592
81.15101.0288
81.15101.0340

Tail pipe

19966
81.15204.5840

Mounting Parts

1.
00971
81.97420.0085
88.15640.2203
81.97420.0152

2.
00958
81.97401.0731
81.97420.0156

3.
04169
81.15204.6054

4.
19447
88.15640.0007

Series F2000

Type

Euro II/III



D2866 LF 6 cyl.
 228K W/310H P
 265K W/360H P
 272K W/370H P
 294K W/400H P
 301K W/409H P
 309K W/420H P

D2876 LF 6 cyl.
 338K W/460H P

T31 F
 18 ton.
 4X2
 16/94 → 07/05

T32 FL
 18 ton.
 4X2
 14/94 → 07/05

T33 FLL
 18/19 ton.
 4X2
 17/94 → 19/02

T50 FLL
 18/19 ton.
 4X2
 01/96 → 02/03

T34 FA
 18 ton.
 4X4
 33/94 → 07/05

Front pipe

10759
81.15204.5420

19758
81.15210.0078
82.99282.8086

D2866 LF

19757
81.15204.0178
82.15201.0042

D2866 LF

14675
81.15210.0085

Right
Excl.T 50

14671
81.15204.5905

Right
Excl.T 50

Silencer

10592
81.15101.0288
81.15101.0340

Tail pipe

19966
81.15204.5840

Mounting Parts

1.
00971
81.97420.0085
88.15640.2203
81.97420.0152

2.
00958
81.97401.0731
81.97420.0156

3.
04169
81.15204.6054

4.
19447
88.15640.0007

Vertical
LHD
Standard

Series F2000

Type

Euro II/III



☞ D2866 LF 6 cyl.
272K W/370H P
294K W/400H P
309K W/420H P

☞ D2876 LF 6 cyl.
338K W/460H P

T35 FNLL
23 ton.
☞ ☞ ☞ ☞ ☞ ☞ ☞
14/97 → 09/04

26 ton.
☞ ☞ ☞ ☞ ☞ ☞ ☞

T36 FNL
21/94 → 07/05

T37 FNLL
14/94 → 36/04

T38 FVL
30/94 → 07/05

26/27/28 ton.
☞ ☞ ☞

T39 DF
27/94 → 12/01

T40 DFL
07/95 → 09/04

T44 DFA
40 ton.
☞ ☞ ☞
19/97 → 07/05.

Vertical
LHD
Standard

Front pipe

10759
81.15204.5420

19758
81.15210.0078
82.99282.8086

☞ D2866 LF

19757
81.15204.0178
82.15201.0042

☞ D2866 LF

14675
81.15210.0085

Right

14671
81.15204.5905

Right

Silencer

10592
81.15101.0288
81.15101.0340

Tail pipe

19966
81.15204.5840

Mounting Parts

1.
00971
81.97420.0085
88.15640.2203
81.97420.0152

2.
00958
81.97401.0731
81.97420.0156

3.
04169
81.15204.6054

4.
19447
88.15640.0007

Series F2000

Type

Euro II/III



D2866 LF
6 cyl.
272K W/370H P
294K W/400H P
309K W/420H P

D2876 LF
6 cyl.
338K W/460H P

T36 FNL
26 ton.
 21/94 → 07/05

T42 DFA
26/33 ton.
 36/94 → 07/05

T48 DF
26/33 ton.
 33/94 → 07/05

Front pipe

10759
81.15204.5420

14675
81.15210.0085

14671
81.15204.5905

19745
81.15210.0084

T42

14667
81.15204.1099
81.15204.1084

Silencer

10592
81.15101.0288
81.15101.0340

Tail pipe

19966
81.15204.5840

Mounting Parts

1.
00971
81.97420.0085
88.15640.2203
81.97420.0152

2.
00958
81.97401.0731
81.97420.0156

3.
04169
81.15204.6054

4.
19447
88.15640.0007

Vertical
LHD
Right

Series F2000

Type

Euro I/II

 **10x8/6**

 D2866 LF
6 cyl.
265K W/360H P
294K W/400H P
301K W/409H P

E18
47/48 ton.
01/89 → 25/97
VFVA

Front pipe

Silencer

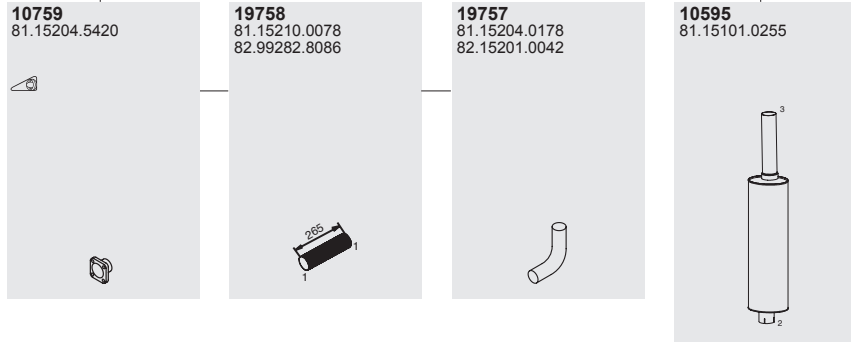

Mounting Parts

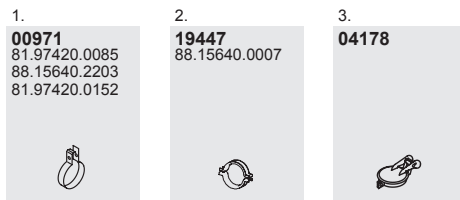

Vertical
LHD
Right

Series F2000

Type

Euro II/III



∅ D2840 LF
10 cyl.
441K W/ 600H P

T62
19 ton.
28/95 → 34/01
FL

T70
26/28 ton.
13/96 → 34/01
DFL

T78
27/28/33 ton.
10/96 → 34/01
DF

Front pipe

Silencer

Tail pipe

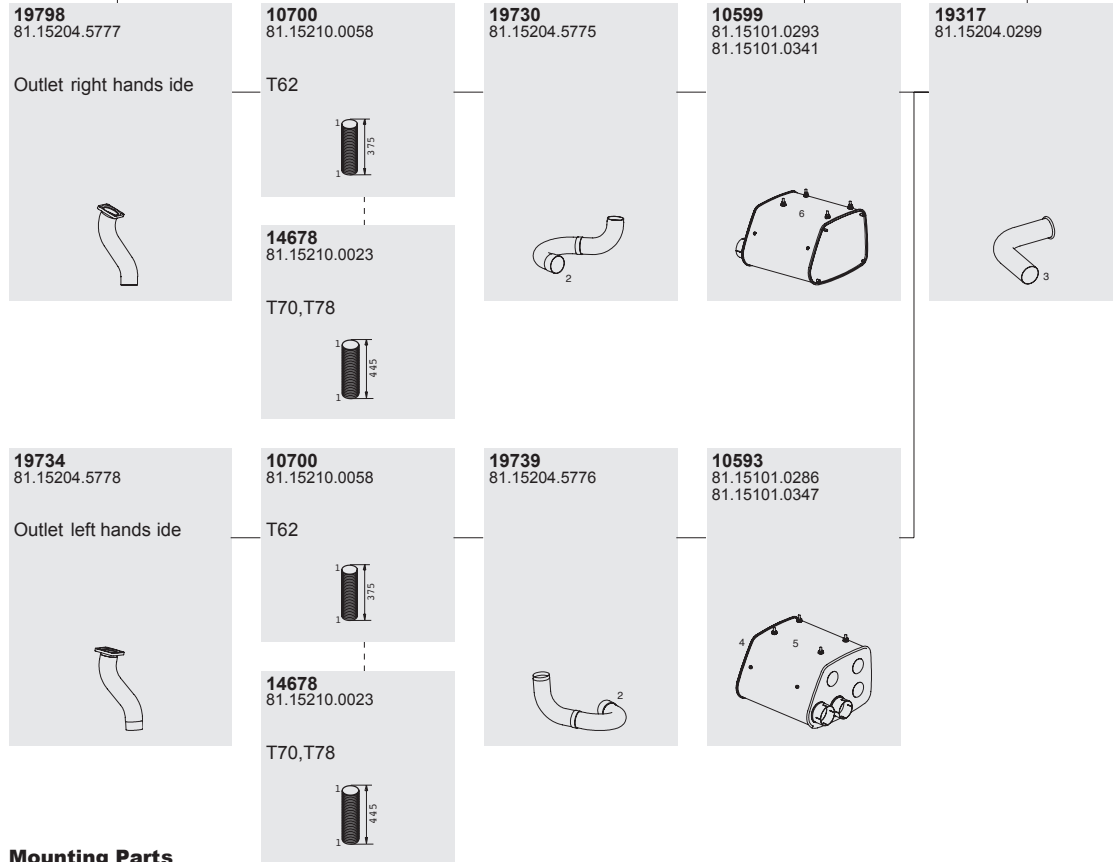

Mounting Parts

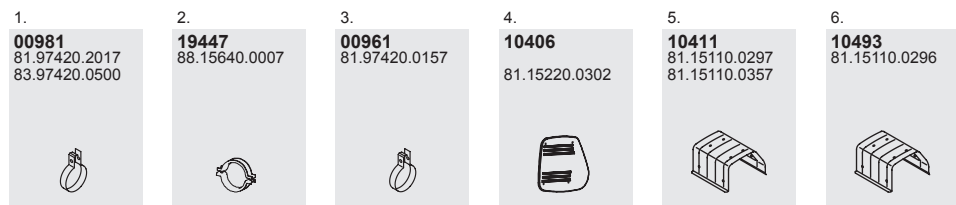

Horizontal
LHD/RHD
Standard

Series F2000

Type

Euro I/II



D2865 LF21-24
5 cyl.
9,97 ltr.

T05
23/24/27 ton.
⑥X②/②
17/94 →
FNLL

Front pipe

10734
81.15204.5691
81.15204.5667

Euro I

10648
81.15204.5751
81.15204.5734

10690
81.15204.5717

Euro II

10645
81.15204.5750

29/94 →

10641
81.15204.5749

10755
81.15210.0054

10647
81.15204.0261

Ref.no. 81.15000.7500

10646
81.15204.0251

Ref.no. 206-742
ZF 16S-151 +1 ntarder
Ref.no. 81.15000.7502

19733
81.15204.5757

T04
Ref.no. 81.15000.7527

Silencer

10591
81.15101.0283

Tail pipe

19354
81.15204.5915

19359
81.15204.5850

Mounting Parts

1.
99710
88.15640.0000
81.97420.0073

2.
99714
81.97420.0085
88.15640.2203
81.97420.0152

3.
49842
81.97488.0100

4.
49910
81.96210.0153
81.96210.0127
81.96210.0602

5.
98414

6.
49892
81.15220.0302

Vertical
LHD
Left

Series F2000

Type

Euro II



D2866
6 cyl.
12,0l tr.

D2876
6 cyl.
12,8l tr.

T35
23/24 ton.
⑥X②/②
17/94 →
FNLL

T36
26 ton.
⑥X②/②
21/94 →
FNL

Front pipe

10643
81.15204.0250



10649
81.15204.5724
81.15204.5940



10755
81.15210.0054



10647
81.15204.0261

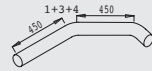

10646
81.15204.0251

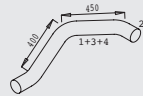

19733
81.15204.5757

T34



Silencer

10591
81.15101.0283

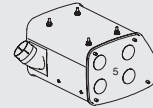

Tail pipe

19354
81.15204.5915

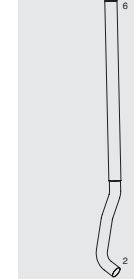

19359
81.15204.5850

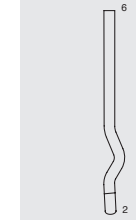

Mounting Parts

1.
00978
88.15640.0000
81.97420.0073



2.
00971
81.97420.0085
88.15640.2203
81.97420.0152



3.
10416
81.97488.0100



4.
10078
81.96210.0153
81.96210.0127
81.96210.0602



5.
10406
81.15220.0302



6.
04171



Vertical
LHD
Left

Series TGL

Type

Euro III

D0834 LFL
4 cyl.

N01
7,5t on.
19/04 →
N03
8t on.
19/04 →
N05
12 ton.
01/04 →
N11
7,5t on.
19/04 →
N13
8t on.
01/04 →
N15
12 ton.
01/04 →
N61
12 ton.
01/06 →

D0836 LFL
6 cyl.

N02
8t on.
19/04 →
N04
12 ton.
01/04 →
N12
8t on.
19/04 →
N14
12 ton.
01/04 →

Horizontal
LHD/RHD
Standard

Front pipe

19637
81.15201.6002

N01, N03, N05, N11,
N13, N15, N61

19620
81.15210.5004

19624
81.15201.0223

19638
81.15204.6096

N02, N04, N12, N14

19623
81.15204.0540

N02, N03

Mounting Parts

1.
00988
06.67041.0124
06.67043.0124

2.
00942
06.67041.0121
81.97420.0023
06.67041.0133

3.
00940
06.67041.0123
06.67042.0122
88.15640.2205

4.
00948
81.97420.0026
81.97420.0062

5.
10055
81.15110.0431

6.
10051
81.15110.0432

Silencer

10503
81.15101.0362

→ 21/05
Silencer w ith bushingsf or
end heat shieldn o. 49934

10509
81.15101.0392

Tail pipe

19341
81.15201.0222

19343
81.15201.0221

F99L -L HD
N01, N03, N05, N11, N13, N15

19344
81.15101.5125

F99L -L HD
N02, N04, N12, N14

Series TGL

Type

Euro III

 
 D0834 LFL
 4 cyl.

N01
 7,5t on.
 19/04 →
N03
 8t on.
 19/04 →
N05
 12 ton.
 01/04 →
N11
 7,5t on.
 19/04 →
N13
 8t on.
 01/04 →
N15
 12 ton.
 01/04 →

 
 D0836 LFL
 6 cyl.

N02
 8t on.
 19/04 →
N04
 12 ton.
 01/04 →
N12
 8t on.
 19/04 →
N14
 12 ton.
 19/04 →

Vertical
 LHD/RHD
 Standard

Front pipe

19637
 81.15201.6002

N01, N03, N05, N11,
 N13, N15

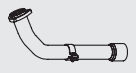

19620
 81.15210.5004



19624
 81.15201.0223

N01, N02, N03, N04,
 N05, N11, N12, N13,
 N14, N15



19638
 81.15204.6096

N02, N04, N12, N14



19623
 81.15204.0540

N02, N03

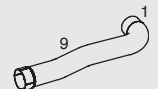

Silencer

10503
 81.15101.0362

→ 21/05
 Silencer with bushings
 for and heat shield no.
 49934

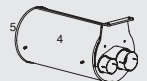

10509
 81.15101.0392

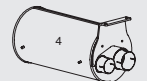

19345
 81.15204.0541

N03, N05



19346
 81.15201.0224



Tail pipe

19342
 81.15201.0225

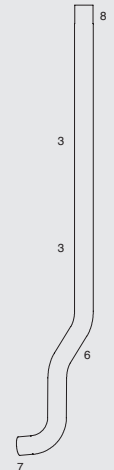

19349
 81.15103.0023



10052
 81.15110.0422



Mounting Parts

1.
00942
 06.67041.0121
 81.97420.0023
 06.67041.0133



2.
00940
 06.67041.0123
 06.67042.0122
 88.15640.2205



3.
10054
 81.97401.5033



4.
10055
 81.15110.0431



5.
10051
 81.15110.0432



6.
00988
 06.67041.0124
 06.67043.0124



7.
00981
 81.97420.2017
 83.97420.0500



8.
04188
 81.15204.6034
 81.15204.6022
 81.15204.5486



9.
00948
 81.97420.0026
 81.97420.0062



Series TGM

Type

Euro III

  **D0836 LFL**
6 cyl.

N08
18 ton.
01/04 →

N18
18 ton.
01/04 →

  **D0836 LFL**
6 cyl.

N48
26 ton.
01/06 →

Front pipe

19638
81.15204.6096



19620
81.15210.5004



19693
81.15204.0542



Silencer

10503
81.15101.0362

→ 21/05
Silencer with bushings or
end heat shield n. 49934

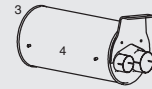

10509
81.15101.0392

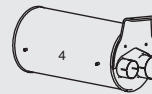

Tail pipe

19341
81.15201.0222

 **F99L/R-** LHD/RHD



19303
81.15101.5127

 **F99L-** LHD
N08. N18

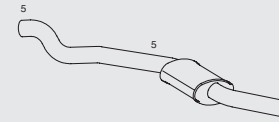

Mounting Parts

1.
00942
06.67041.0121
81.97420.0023
06.67041.0133



2.
00940
06.67041.0123
06.67042.0122
88.15640.2205



3.
10051
81.15110.0432



4.
10055
81.15110.0431



5.
00988
06.67041.0124
06.67043.0124



Horizontal
LHD/RHD
Standard

Series TGM

Type

Euro III

 
D0836LFL
6 cyl.

N08
18 ton.
01/04 →

N18
18 ton.
01/04 →

 
D0836
6 cyl.

N48
26 ton.
01/06 →

Front pipe

19638
81.15204.6096



19620
81.15210.5004



19693
81.15204.0542



Silencer

10503
81.15101.0362

→ 21/05
Silencer with bushings or
end heat shield n. 49934

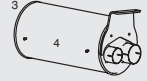

10509
81.15101.0392



19346
81.15201.0224

 F99L/R10/12 -L HD/RHD



19309
81.15204.0543



Tail pipe

19349
81.15103.0023



10052
81.15110.0422



Mounting Parts

1.
00942
06.67041.0121
81.97420.0023
06.67041.0133



2.
00940
06.67041.0123
06.67042.0122
88.15640.2205



3.
10051
81.15110.0432



4.
10055
81.15110.0431



5.
00988
06.67041.0124
06.67043.0124



6.
00981
81.97420.2017
83.97420.0500



7.
10054
81.97401.5033



8.
04188
81.15204.6034
81.15204.6022
81.15204.5486



Vertical
LHD/RHD
Standard

Series TGA

Type

Euro III

④X②, ⑥X②/②

④X②⑥X②/②

CUMMINS engine ISME 280K W/380H P 309K W/420H P

H07
18 ton.
④X②
19/02 →

H27
26 ton.
⑥X②/②
10/99 →

H31
26 ton.
⑥X②/②
24/02 → 20/05

H32
26 ton.
⑥X②/②
24/02 →

Front pipe

14776
81.15205.5082
81.15205.5194

1) → 24/02
With/without jake rake, jake brake+ESP

2) 25/02 →
Jakeb rake



19701
81.15210.0086



14687
81.15204.0521



N.A.

81.15201.0220



14772
81.15201.5762
81.15205.5193



Silencer

10590
81.15101.0335
81.15101.0346

Jakeb rake



10545
81.15101.0332
81.15101.0345

ADR
Incl. Tank trucks Jakeb rake



10544
81.15101.0331
81.15101.0344

Cat.
F99L
,LHD

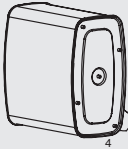

Mounting Parts

1.
00971
81.97420.0085
88.15640.2203
81.97420.0152



2.
10404
81.15502.0027



3.
10078
81.96210.0153
81.96210.0127
81.96210.0602



4A.
10402
81.15110.0361



4B.
10477

INOX



Horizontal
LHD/RHD
Left

Series TGA

Type

Euro III



☛ D2066 LF
10,5l tr.
6 cyl.
228K W/310H P
257K W/350H P
287K W/390H P
316K W/430H P



☛ D2676 LF
12,4l tr.
6 cyl.
353K W/480H P

32/35/41/50 ton.

- H37 →
- H39 →
- H41 →
- H49 →
- H50 →
- H59 →
- H90 →
- H93 →
- H96 →
- HW3 →
- HW6 →
- 01/06 →

Horizontal
LHD/RHD
Standard

Front pipe

Silencer

Tail pipe

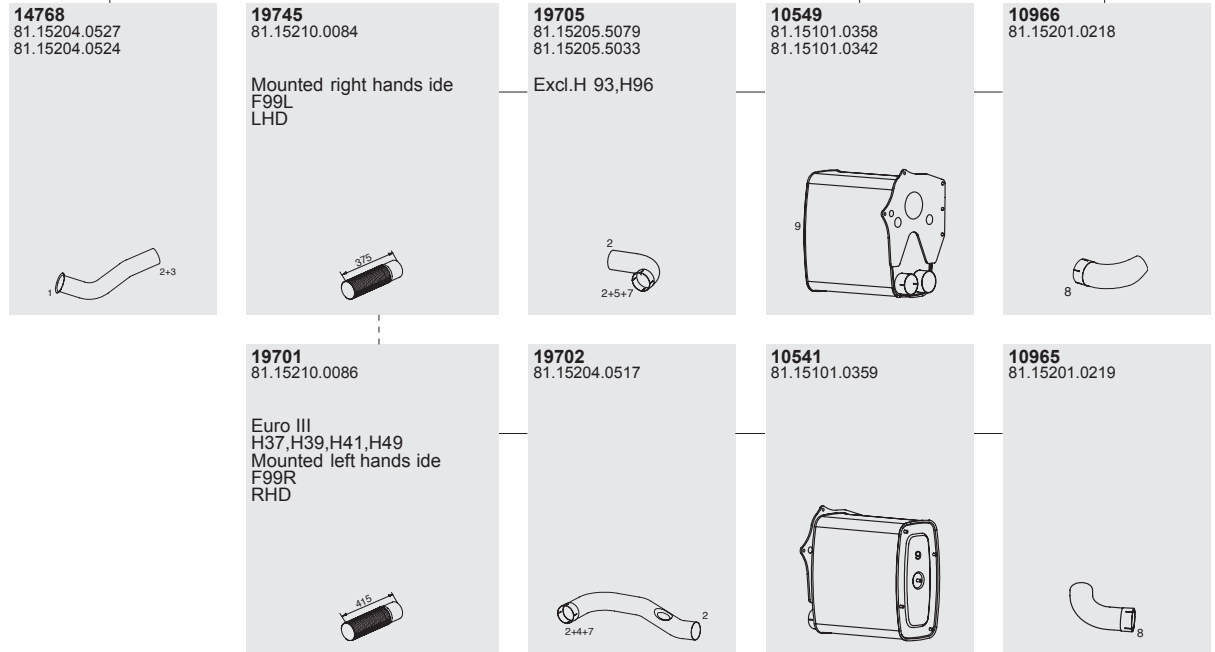

Mounting Parts

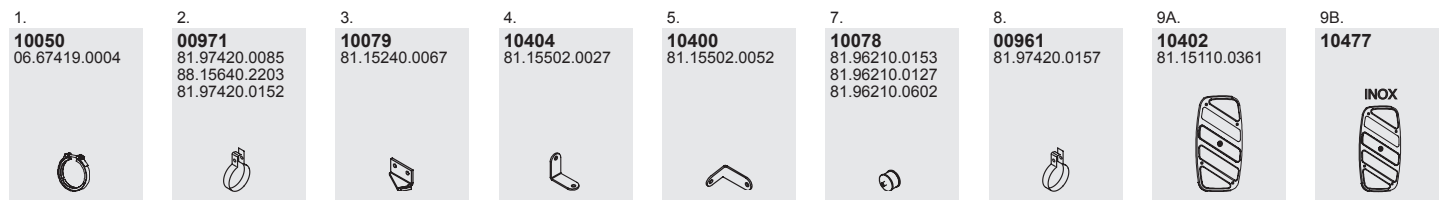

Series TGA

Type

Euro III



D2866
12,0l tr.
6 cyl.
228K W/310H P
265K W/360H P
301K W/410H P

D2876
12,8l tr.
6 cyl.
338K W/460H P
353K W/480H P
375K W/510H P
390K W/530H P

H36, 35 ton.
H38, 41/50 ton.
H40, 32/35 ton.

Horizontal
LHD
Standard

Front pipe

19749
81.15204.0452

19743
81.15204.5942

19745
81.15210.0084

Silencerm ounted
right hands ide

19705
81.15205.5079
81.15205.5033

19740
81.15204.0501

D2876L F05

19742
81.15205.5021

19701
81.15210.0086

Silencerm ounted
left hands ide

19702
81.15204.0517

Silencer

10549
81.15101.0358
81.15101.0342

Silencerm ounted
right hands ide

10541
81.15101.0359

Silencerm ounted
left hands ide

Tail pipe

10966
81.15201.0218

10965
81.15201.0219

Mounting Parts

1.
00971
81.97420.0085
88.15640.2203
81.97420.0152

2.
10079
81.15240.0067

3.
10400
81.15502.0052

4.
10078
81.96210.0153
81.96210.0127
81.96210.0602

5.
10404
81.15502.0027

6.
10402
81.15110.0361

6. Alternative.
10477
INOX

7.
00961
81.97420.0157

Series TGA

Type

Euro III

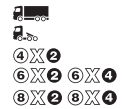

☛ D2866
12,0l tr.
6 cyl.
228K W/310H P
265K W/360H P
301K W/410H P

☛ D2876
12,8l tr.
6 cyl.
338K W/460H P
353K W/480H P
375K W/510H P
390K W/530H P

H02, 18 ton.
H05, 18 ton.
H09, 18 ton.
H12, 18 ton.
H17, 26 ton.
H20, 26 ton.
H23, 26 ton.
H25, 26/33 ton.
H29, 26/33 ton.
H51, 18 ton.
H55, 26/33 ton.
H86, 33 ton.

Front pipe

<p>19749 81.15204.0452</p>	<p>19743 81.15204.5942</p>
<p>19744 81.15204.0486</p>	<p>19741 81.15205.5008</p>
<p>19740 81.15204.0501</p> <p>D2876L F05</p>	<p>19742 81.15205.5021</p>

19701
81.15210.0086

19708
81.15204.0451
81.15205.5116

Excl.H 51,H55

19767
81.15205.5045

H51,H55

Silencer

10590
81.15101.0335
81.15101.0346

10545
81.15101.0332
81.15101.0345

ADR

10544
81.15101.0331
81.15101.0344

Cat.

Mounting Parts

<p>1.</p> <p>00971 81.97420.0085 88.15640.2203 81.97420.0152</p>	<p>2.</p> <p>10079 81.15240.0067</p>	<p>3.</p> <p>10078 81.96210.0153 81.96210.0127 81.96210.0602</p>	<p>4. → 15.00</p> <p>10070 81974880463</p>	<p>4. 15.00 →</p> <p>10404 81.15502.0027</p>	<p>5.</p> <p>10402 81.15110.0361</p>	<p>5. Alternative.</p> <p>10477</p> <p>INOX</p>
---	---	---	---	---	---	--

Horizontal
LHD
Standard

Series TGA

Type

Euro III

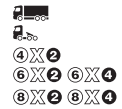

D2866
12,0l tr.
6 cyl.
228K W/310H P
265K W/360H P
301K W/410H P

D2876
12,8l tr.
6 cyl.
338K W/460H P
353K W/480H P
375K W/510H P
390K W/530H P

H02, 18 ton.
H05, 18 ton.
H09, 18 ton.
H12, 18 ton.
H17, 26 ton.
H20, 26 ton.
H23, 26 ton.
H25, 26/33 ton.
H29, 26/33 ton.
H36, 35 ton.
H38, 41/50 ton.
H40, 32/35 ton.
H86, 33 ton.

Vertical
LHD
Standard

Front pipe

19744
81.15204.0486

EVV

19741
81.15205.5008

19701
81.15210.0086

19706
81.15204.0519

H36, H38, H40

10542
81.15101.0353
81.15101.0360

H36, H38, H40

10958
81.15204.0520

H36, H38, H40

10962
81.15204.0485

→ 14/02

10960
81.15204.5844

19740
81.15204.0501

D2876L F05

19742
81.15205.5021

19707
81.15204.0483

10543
82.15101.0024
81.15101.0333

10963
81.15204.0484
81.15204.0506

F99L15

10403
81.15204.0505

15/02 →

10961
81.15110.0372
81.15110.0417

Mounting Parts

1.
00971
81.97420.0085
88.15640.2203
81.97420.0152

2.
10409
81.15110.5311

3.
10474
81151105304

4.
10072
06671240341

5.
10073
81974205045

6.
04168
81152046060
81152046067

7.
10079
81.15240.0067

8.
10404
81.15502.0027

9.
10402
81.15110.0361

9. Alternative.
10477
INOX

SOYLU / EURO I, II, III

MERCEDES



Econic	200
Unimog	203
Vario	208
Atego	210
Axor	219
Actros	230

Series ECONIC

Type

Euro III



4X2

03.1998 →

1823L-1833L

18 ton.

OM 906.940
6,4l tr.

170K W/231H P

OM 906.941

6,4l tr.

205K W/279H P

6X4

01.1998 →

2628L-2633L

26 ton.

OM 906.941

OM 906.952

6,4l tr.

205K W/279H P

6X2/3

03.1998 →

2628L-2633L

26 ton.

OM 906.941

6,4l tr.

205K W/279H P

Baumuster

957.540

957.541

957.542

957.543

957.653

957.654

957.656

957.657

957.660

957.661

957.662

957.663

957.664

957.681

957.682

Front pipe

28712

957.490.1120

957.490.0420

CHno V207575

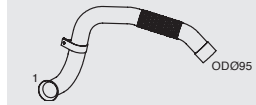

23682

957.492.1201

CHno V207575

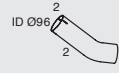

25728

957.490.0120

EXCL.B M 957.540, 957.660

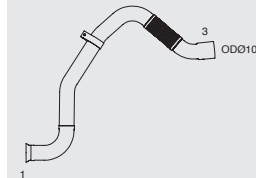

Silencer

28107

940.490.0101

Road vehicle

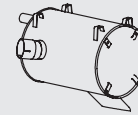

27554

940.490.0501

GGVS

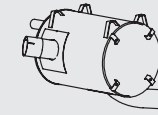

27586

940.490.0601

Constructions ite vehicle
EXCL.B M 957.540, 957.660

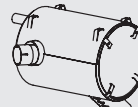

Mounting Parts

1.

28426

620.997.0590



2.

00988

071.555.100.501

940.492.0340



3.

00984

000000001647

000000001646



Horizontal
LHD/RHD
Standard

Series ECONIC

Type

Baumuster

Euro III



03.1998 →

1823L-1833L

18 ton.

OM 906.940
6,4l tr.
170K W/231H P

OM 906.941
6,4l tr.
205K W/279H P



01.1998 →

2628L-2633L

26 ton.

OM 906.941
OM 906.952
6,4l tr.
205K W/279H P



03.1998 →

2628L-2633L

26 ton.

OM 906.941
6,4l tr.
205K W/279H P

Horizontal
LHD/RHD
Standard

957.541
957.542
957.543
957.653
957.654
957.656
957.657
957.660
957.661
957.662
957.663
957.664
957.681
957.682

Front pipe

Silencer

25692

942.490.3619
948.490.4719

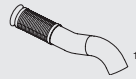

25625

942.490.2119
942.490.1119
942.492.3301



28128

942.490.2601
942.490.3701
942.490.2701
Road vehicle

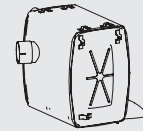

Mounting Parts

1.

00958

645.492.0440
071.555.130.500
942.492.0140



Series ECONIC

Type

Euro III



④X②
03.1998 →
1823L-1833L
18 ton.

OM 906.940
6,4l tr.
170K W/231H P

OM 906.941
6,4l tr.
205K W/279H P

⑥X④
01.1998 →
2628L-2633L
26 ton.

OM 906.941
OM 906.952
6,4l tr.
205K W/279H P

⑥X②/④
03.1998 →
2628L-2633L
26 ton.

OM 906.941
6,4l tr.
205K W/279H P

Vertical
LHD/RHD
Standard

Baumuster

957.540
957.541
957.542
957.543
957.653
957.654
957.656
957.657
957.660
957.661
957.662
957.663
957.664
957.681
957.682

Front pipe

28712
957.490.1120
957.490.0420
▶CHno V207575

23682
957.492.1201
▶CHno V207575

26645
957.492.1901
957.490.0720
EXCL.B M 957.540,
957.660

23776
957.490.1220
957.490.0620
EXCL.B M 957.540, 957.660

28610
957.490.0520
EXCL.B M 957.540,
957.660

25728
957.490.0120
EXCL.B M 957.540, 957.660

Silencer

27581
940.490.0301
▶CHno V207575

Tail pipe

25931
940.492.0004
▶CHno V207575

27398
940.492.0804
EXCL.B M 957.540,
957.660

Mounting Parts

1.
28426
620.997.0590

2.
00940
071.555.090.501
395.492.0040
645.492.1140

3.
00988
071.555.100.501
940.492.0340

4.
00984
000000001647
000000001646

5.
28434
620.492.0640

6.
27072
387.490.0030

7.
08786
645.492.0118
346.492.0040

8.
27073
655.490.0130



Series UNIMOG

Type

Euro I/II
01/1988 →

 WB 2650
8,5t on.

U1000

 OM 366.915
 OM 356.914
6,0l tr.
6 cyl.
75 KW/102 HP

Baumuster

427.100

Front pipe

21635
427.492.0601



21793
427.492.0701



Silencer

27580
435.490.0901
371.490.7101
371.490.7201



Tail pipe

25991
427.492.0006



Mounting Parts

1.
00942
674.490.2819
303.493.0643
071.555.085.502



2.
00940
071.555.090.501
395.492.0040
645.492.1140



Horizontal
LHD
Standard

Series UNIMOG

Type

Euro II
1988 →



U1200
U1200T
U1250
U1250L
U1400
U1450
U1450L
U1600
U1650
U1650L

WB 2650, 3250

OM 366A
6,0l tr.
6 cyl.
92 KW/125 HP
100K W/136H P
114K W/155H P

OM 366L A
6,0l tr.
6 cyl.
100K W/136H P
150K W/204H P
155K W/211H P
157K W/214H P
177K W/240H P
177K W/241H P

Baumuster

427.000
427.101
427.102
427.105
427.110
427.111
427.112
427.115
427.116

Front pipe

21797
427.490.0119
BM 427.000, 101, 102, 110-112
→ ID No.: 182302

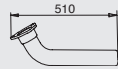

21739
427.492.0201
Excl.B M 427.000

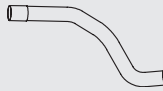

21796
427.492.0301
BM 427.110-112, 115, 116

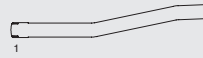

21799
427.490.0019
BM 427.105,1 15,1 16
BM 427.000, 101,102, 110-112:
ID No.: 182303 →

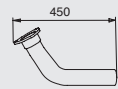

21668
427.492.0801
BM 427.000

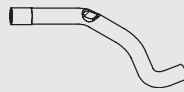

Silencer

27580
435.490.0901
371.490.7101
371.490.7201

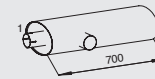

Tail pipe

25991
427.492.0006
BM 427.101, 102, 105



25999
427.492.0206
BM 427.110-112, 115, 116



21987
427.490.0021
BM 427.000



Mounting Parts

1.
00942
674.490.2819
303.493.0643
071.555.085.502



2.
00940
071.555.090.501
395.492.0040
645.492.1140



Horizontal
LHD
Standard

Series UNIMOG

Type Baumuster

Euro II
437.105
437.116
437.117
437.118
437.125
437.135
437.136

U 1550L
05/1988 →
01/1992 →
WB 3250, 3700
8,5t on.
9,5t on.

U 2100
09/1989 →
WB 2810
12,5t on.

U 2150,U 2150L
09/1989 →
WB 3250, 3850
12,5t on.
14 ton.

OM 366L A
6,0l tr.
6 cyl.
150K W/204H P
155K W/211H P
157K W/214H P
177K W/240H P

OM 366A
6,0l tr.
6 cyl.
100K W/136H P
114K W/155H P
125K W/170H P

Horizontal
LHD
Standard

Front pipe

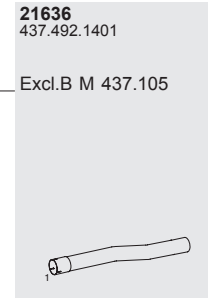
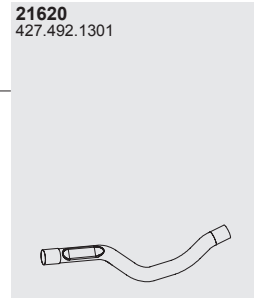
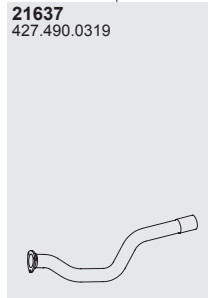

Silencer

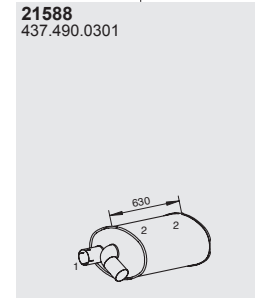

Tail pipe

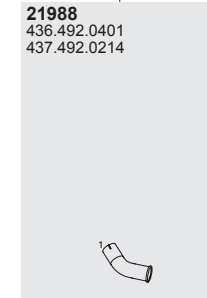

Mounting Parts

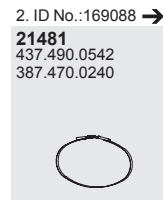
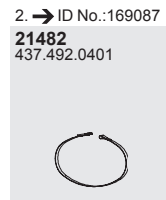
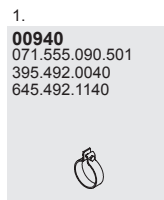

Series UNIMOG

Type Baumuster

Euro II/III
408.100
408.215



6,2t on.
6,5t on.
6,6t on.

07/1996 →

U9 0, U 100L
OM 602.989
OM 602.981
2,9l tr.
5 cyl.
85 KW/116 HP
90 KW/122 HP

11/1992 →

U90
OM 602.941
2,9l tr.
5 cyl.
65 KW/88H P

U100L
OM 602.948
2,9l tr.
5 cyl.
71 KW/97H P

Horizontal
LHD
Standard

Front pipeT

Silencer

ail pipe

21629
408.490.0119
BM 408.215

21622
408.490.0219
BM 408.215

28187
601.490.3601
601.490.3201
601.490.1901

21986
408.492.0014

21623
408.490.0019
408.492.0001
BM 408.100

21628
408.492.0901
408.492.0101
BM 408.100

Mounting Parts

1.
00925
071.555.053.500

2.
21487
900.288.202.100
900.288.203.100

3.
21485
408.492.0230

Series UNIMOG

Type

Baumuster

Euro II

427.107



427.117

427.118

WB 2650
WB 3250

10 ton.
10,7t on.

U 1600
01/1988 →
☞ **OM 366.949**
☞ **OM 356.956**
6,0l tr.
6 cyl.
115K W/156H P

U 1650
U 1650L

01/1988 →
☞ **OM 366.948**
☞ **OM 366.949**
☞ **OM 356.956**
6,0l tr.
6 cyl.
115K W/156H P

09/1989 →
☞ **OM357.924**
☞ **OM 366.984**
☞ **OM 356.997**
6,0l tr.
6 cyl.
150K W/204H P
157k W/214H P

05/1991 →
☞ **OM 356.980**
☞ **OM 357.945**
6,0l tr.
6 cyl.
177K W/241H P

Horizontal
LHD
Standard

Front pipe

21624
427.490.0419



21620
427.492.1301



21397
427.492.0906

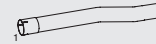

Excl.B M 427.107

Silencer

21588
437.490.0301

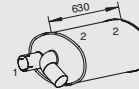

Tail pipe

21988
436.492.0401
437.492.0214



Mounting Parts

1.
00940
071.555.090.501
395.492.0040
645.492.1140



2.
21481
437.490.0542
387.470.0240



Series VARIO

Type

Euro II



- 512 D
- 612 D
- 614 D
- 812 D
- 814 D
- 815 D
- 810 D
- 814 DA
- 815 DA



- O 810
- O 815

Baumuster

- 667.321
- 667.322
- 667.323
- 667.351
- 667.352
- 667.353
- 668.321
- 668.322
- 668.323
- 668.331
- 668.332
- 668.351
- 668.352
- 668.353
- 670.321
- 670.322
- 670.323
- 670.324
- 670.331
- 670.332
- 670.351
- 670.352
- 670.353
- 670.373
- 670.374
- 670.398
- 670.421
- 670.422
- 670.423
- 670.431
- 670.432
- 670.451
- 670.452
- 670.453

Front pipe

21784
668.490.3319
668.490.3019

OM904

25617
667.490.2619

OM602

25788
668.490.3219

25616
668.490.3119

Silencer

28112
667.490.0001

18574

Cat.

Tail pipe

25917
668.492.5604

►CHno 079.193
WB 3150

25918
668.492.5804

►CHno 079.193
WB 3700, 4250

25916
668.492.6404

►CHno 079.193
WB 4800

25911
668.492.6004

Rear outlet
WB 3150

25915
668.492.6104

Rear outlet
WB 3700

25919
668.492.6204
668.492.6504

Rear outlet
WB 4250
BM 667.323, 353, 668.323, 353, 670.323,
353, 373
WB 4800
BM 370.324, 374

25959
668.492.5904

Side outleta fterr eara xle

Mounting Parts

1.
00932
071.555.065.501

2.
28099
667.492.5741

3.
28012
668.492.0340

4.
28063
673.492.0140
313.392.0340

5.
28094
667.490.0441

6.
28480
381.492.0082
301.492.0382
0201.175.00

7.
00992
071.555.075.502

8.
27479
620.492.6241
396.492.3241

9.
28048
667.492.6241
662.492.6241

10.
28478
620.997.0490

11. Kit
18893

12. Cat. retrofit
18573

13. Kit
18533

Horizontal
LHD
Standard

Series VARIO

Type

Euro II



- 512 D
- 612 D
- 614 D
- 812 D
- 814 D
- 815 D
- 810 D
- 814 DA
- 815 DA



- O 810
- O 815

Baumuster

- 667.321
- 667.322
- 667.323
- 667.351
- 667.352
- 667.353
- 668.321
- 668.322
- 668.323
- 668.331
- 668.332
- 668.351
- 668.352
- 668.353
- 670.321
- 670.322
- 670.323
- 670.324
- 670.331
- 670.332
- 670.351
- 670.352
- 670.353
- 670.373
- 670.374
- 670.398
- 670.421
- 670.422
- 670.423
- 670.431
- 670.432
- 670.451
- 670.452
- 670.453

Front pipe T

21784
668.490.3319
668.490.3019

OM904

25617
667.490.2619

OM602

25788
668.490.3219

25616
668.490.3119

Silencer

28112
667.490.0001

18574

Silencer/Cat.

ail pipe

25953
668.492.5504

28932
668.492.2804

Standard, Left hand side outlet.

25952
668.492.4604

Used with underrun protection

25951
670.490.0121

BM 667.321, 351,
668.321, 331, 351,
670.321, 331, 351

Mounting Parts

1.
00932
071.555.065.501

2.
28099
667.492.5741

3.
28012
668.492.0340

4.
28063
673.492.0140
313.392.0340

5.
28094
667.490.0441

6.
28480
381.492.0082
301.492.0382
0201.175.00

7.
00992
071.555.075.502

8.
27479
620.492.6241
396.492.3241

9.
28048
667.492.6241
662.492.6241

10.
28478
620.997.0490

11. Kit
18833

12. Kit
18893

13. Cat. retrofit
18573

Horizontal
LHD
Standard

Series ATEGO

Type

Euro II/III

OM 904L A
4,2l tr.
4 cyl.
90 KW/122 HP
112K W/152H P
125K W/170H P



- 712
- 714
- 714K /L
- 715
- 715K /L
- 717
- 717K /L
- 812
- 814
- 814K /L
- 815
- 815F /K/L
- 817
- 817F /K/L
- 915A F
- 917
- 917A F/K/KO/L
- 1017
- 1017A /AK
- 1017K /KO/L
- 1214
- 1214K /L
- 1215
- 1215K /L
- 1217
- 1217K /KO/L
- 1317
- 1317A /AK/K/KO
- 1317L /LKO
- 1517
- 1517K /L

Baumuster

- | | | |
|---------|---------|---------|
| 970.001 | 970.215 | 976.332 |
| 970.002 | 970.217 | 976.333 |
| 970.003 | 970.223 | 976.334 |
| 970.005 | 970.225 | |
| 970.011 | 970.227 | |
| 970.012 | 970.233 | |
| 970.013 | 970.235 | |
| 970.015 | 970.237 | |
| 970.017 | 970.243 | |
| 970.021 | 970.245 | |
| 970.022 | 970.247 | |
| 970.023 | 970.253 | |
| 970.024 | 970.255 | |
| 970.025 | 970.257 | |
| 970.027 | 970.258 | |
| 970.031 | 970.265 | |
| 970.032 | 970.267 | |
| 970.033 | 970.268 | |
| 970.035 | 970.273 | |
| 970.037 | 970.275 | |
| 970.043 | 970.277 | |
| 970.045 | 970.278 | |
| 970.047 | 972.011 | |
| 970.050 | 972.012 | |
| 970.053 | 972.021 | |
| 970.055 | 972.022 | |
| 970.057 | 972.031 | |
| 970.058 | 972.032 | |
| 970.059 | 972.041 | |
| 970.060 | 972.052 | |
| 970.063 | 972.053 | |
| 970.065 | 972.062 | |
| 970.067 | 972.072 | |
| 970.068 | 972.342 | |
| 970.073 | 972.362 | |
| 970.075 | 975.031 | |
| 970.077 | 975.041 | |
| 970.078 | 975.052 | |
| 970.203 | 975.062 | |
| 970.205 | 975.262 | |
| 970.211 | 976.011 | |
| 970.212 | 976.012 | |
| 970.213 | 976.013 | |

Horizontal
LHD
Standard

Front pipe

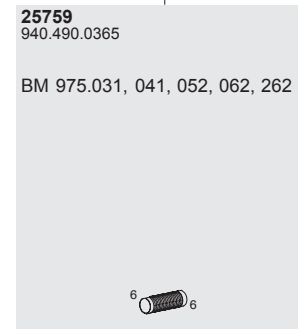
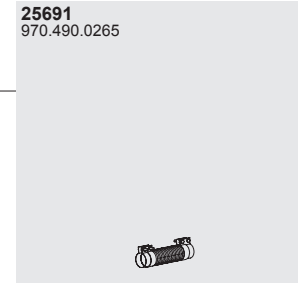
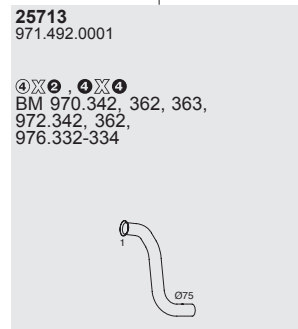
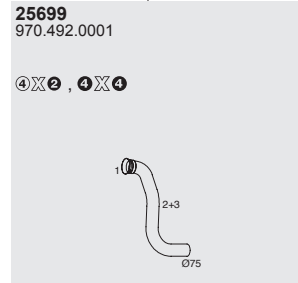

Silencer

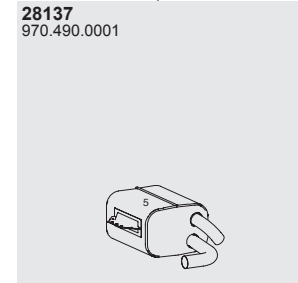

Tail pipe

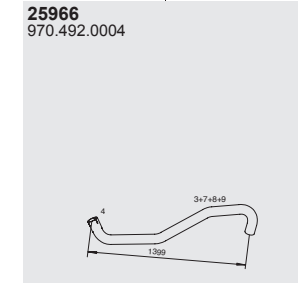

Mounting Parts

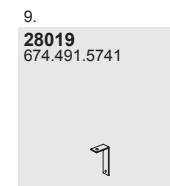
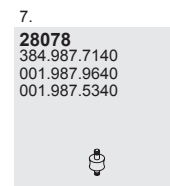
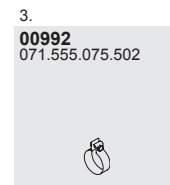
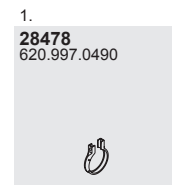

Series ATEGO

Type

Euro II/III

OM 906L A
6,4l tr.
6 cyl.
170K W/231H P
205K W/279H P



- 823
- 823K /L
- 923
- 923K /L
- 1023
- 1023L
- 1223
- 1223L
- 1225A F/F
- 1228
- 1228L
- 1229
- 1323
- 1323 L/LKO/LS
- 1325
- 1325A F/F
- 1328
- 1328 AF/F/L/LS
- 1523
- 1523A /AK
- 1523K /KO/L
- 1525A F
- 1528
- 1528A F/F/L

Baumuster

- | | |
|---------|---------|
| 970.021 | 970.268 |
| 970.022 | 970.273 |
| 970.023 | 970.275 |
| 970.024 | 970.277 |
| 970.025 | 970.278 |
| 970.027 | 970.362 |
| 970.031 | 970.363 |
| 970.032 | 970.373 |
| 970.033 | 972.021 |
| 970.035 | 972.031 |
| 970.037 | 972.072 |
| 970.043 | 972.372 |
| 970.045 | 974.262 |
| 970.047 | 974.263 |
| 970.050 | 975.072 |
| 970.053 | 975.262 |
| 970.055 | 976.053 |
| 970.057 | 976.054 |
| 970.058 | 976.063 |
| 970.059 | 976.064 |
| 970.063 | 976.065 |
| 970.065 | 976.075 |
| 970.067 | 976.077 |
| 970.068 | 976.332 |
| 970.073 | 976.334 |
| 970.075 | 976.353 |
| 970.077 | 976.354 |
| 970.078 | 976.363 |
| 970.221 | 976.364 |
| 970.222 | 976.373 |
| 970.223 | 976.374 |
| 970.225 | |
| 970.227 | |
| 970.233 | |
| 970.235 | |
| 970.237 | |
| 970.243 | |
| 970.253 | |
| 970.255 | |
| 970.257 | |
| 970.258 | |
| 970.265 | |
| 970.267 | |

Front pipe

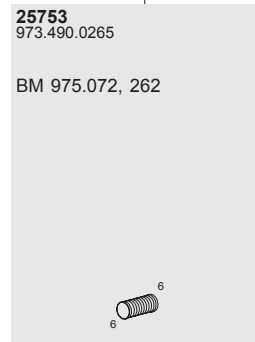
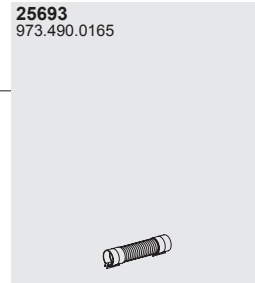
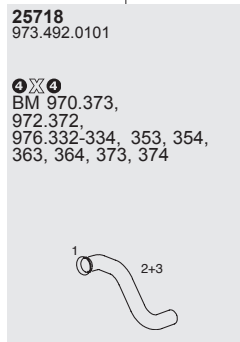

Silencer

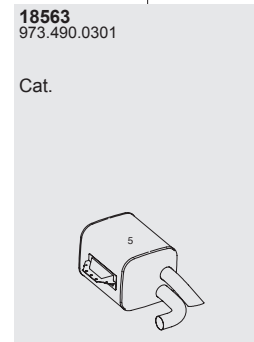
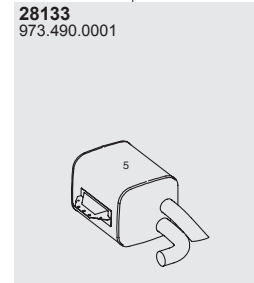

Tail pipe

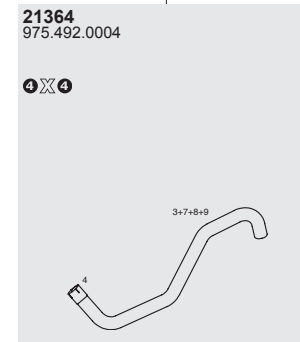
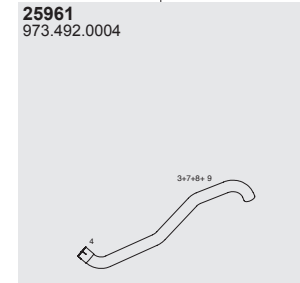

Mounting Parts

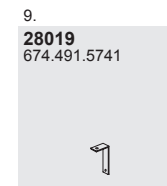
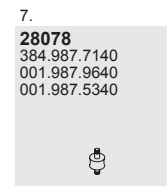
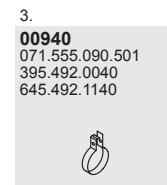
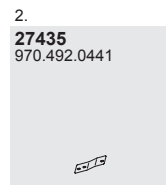
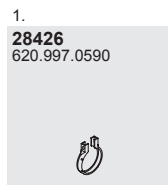

Horizontal
LHD
Standard

Series ATEGO

Type

Euro II/III
 18 ton. →
 OM 906
 6,37 ltr.
 6 cyl.
 170K W/231H P
 205K W/279H P



1823
 1823A K
 1823K
 1823L
 1823 LS
 1828
 1828A
 1828A K
 1828K
 1828L
 1828 LS
 2523L
 2528L
 2628
 2628B
 2628K

Baumuster

950.501 957.553
 950.502 957.554
 950.503 957.555
 950.504 957.556
 950.505 957.661
 950.506 957.662
 950.507 957.663
 950.508 957.664
 950.509
 950.531
 950.532
 950.533
 950.534
 950.535
 950.536
 950.537
 950.538
 950.539
 950.562
 950.563
 950.602
 950.603
 950.604
 950.605
 950.623
 950.624
 950.625
 950.626
 950.642
 950.643
 952.502
 952.503
 952.562
 952.563
 952.641
 952.642
 952.643
 953.641
 953.643
 954.532
 957.541
 957.542
 957.543

Front pipe

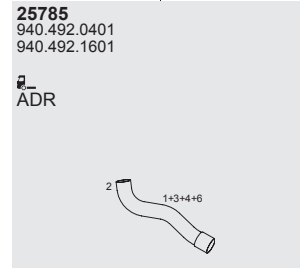
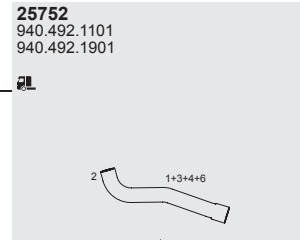
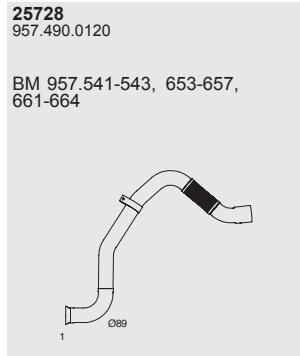
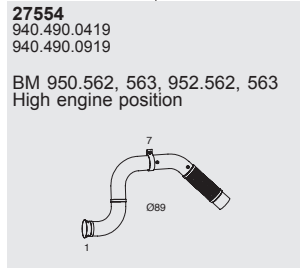
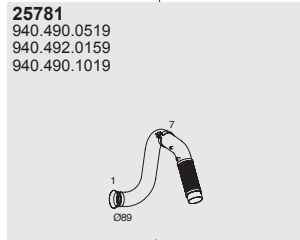

Silencer

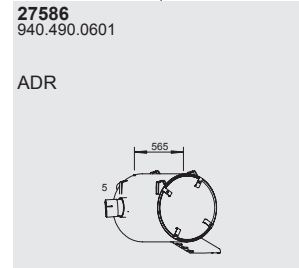
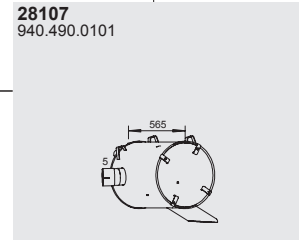

Mounting Parts

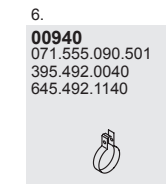
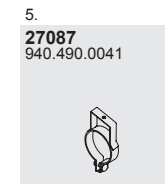
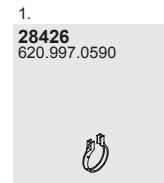

Horizontal
 LHD
 Standard

Series ATEGO

Type

Euro II/III
 OM 904L A
 4,2l tr.
 4 cyl.
 90 KW/122 HP
 112K W/152H P
 125K W/170H P
 712
 714
 714K /L
 715
 715K /L
 717
 717K /L
 812
 814
 814K /L
 815
 815F /K/L
 817
 817F /K/L
 915A F
 917
 917A F/K/KO/L
 1017
 1017A /AK
 1017K /KO/L
 1214
 1214K /L
 1215
 1215K /L
 1217
 1217K /KO/L
 1317
 1317A /AK
 1317
 K/KO/L/LKO
 1517
 1517K /L

Baumuster

970.001 970.215 976.334
 970.002 970.217
 970.003 970.223
 970.005 970.225
 970.011 970.227
 970.012 970.233
 970.013 970.235
 970.015 970.237
 970.017 970.245
 970.021 970.247
 970.022 970.253
 970.023 970.255
 970.024 970.257
 970.025 970.258
 970.027 970.265
 970.031 970.267
 970.032 970.268
 970.033 970.273
 970.035 970.275
 970.037 970.277
 970.043 970.278
 970.045 972.011
 970.047 972.012
 970.050 972.021
 970.053 972.031
 970.055 972.032
 970.057 972.041
 970.058 972.052
 970.059 972.053
 970.060 972.062
 970.063 972.072
 970.065 972.342
 970.067 972.362
 970.068 975.031
 970.073 975.041
 970.075 975.052
 970.077 975.062
 970.078 975.262
 970.203 976.011
 970.205 976.012
 970.211 976.013
 970.212 976.332
 970.213 976.333

Front pipe

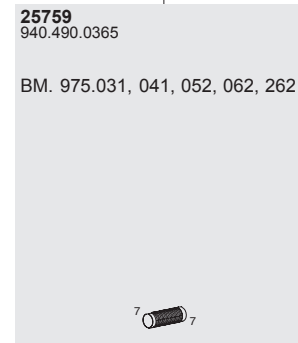
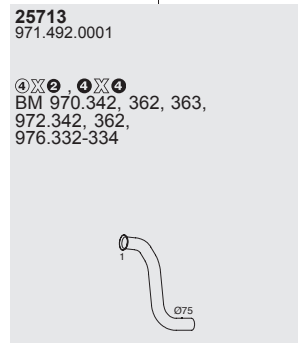
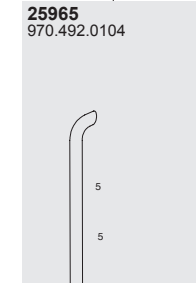
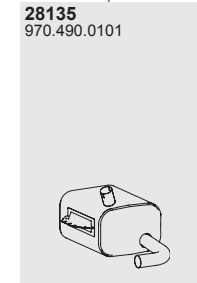
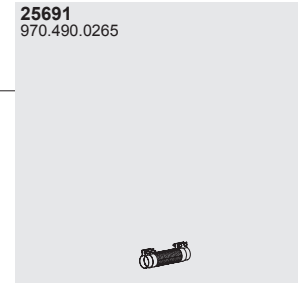
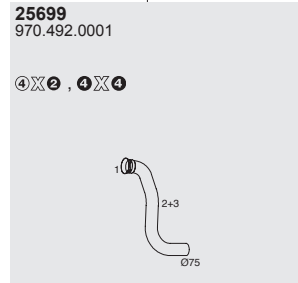

Mounting Parts

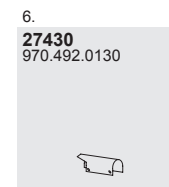

Vertical
 LHD
 Standard

Series ATEGO

Type

Euro II/III

OM 906L A
6,4l tr.
6 cyl.
170K W/231H P
205K W/279H P



823
823K /L
923
923K /L
1023
1023L
1223
1223L
1225A F/F
1228
1228L
1229
1323
1323 L/LKO/LS
1325
1325A F/F
1328
1328 AF/F/L/LS
1523
1523A /AK
1523K /KO/L
1525A F
1528
1528A F/F/L

Baumuster

970.021 970.268
970.022 970.273
970.023 970.275
970.024 970.277
970.025 970.278
970.027 970.362
970.031 970.363
970.032 970.373
970.033 972.021
970.035 972.031
970.037 972.072
970.043 972.372
970.045 974.262
970.047 974.263
970.050 975.062
970.053 975.072
970.055 975.262
970.057 976.053
970.058 976.054
970.059 976.063
970.063 976.064
970.065 976.065
970.067 976.075
970.068 976.077
970.073 976.332
970.075 976.334
970.077 976.353
970.078 976.354
970.221 976.363
970.222 976.364
970.223 976.373
970.225 976.374
970.227
970.233
970.235
970.237
970.243
970.253
970.255
970.257
970.258
970.265
970.267

Front pipe

25647
973.492.0001

4X2, 4X4

25693
973.490.0165

25718
973.492.0101

4X4
BM 970.373,
972.372,
976.332-334, 353, 354, 363, 364, 373, 374

25753
973.490.0265

BM 975.072, 262

Silencer

28134
973.490.0101

Tail pipe

25962
973.492.0104

27434
970.492.0030

Mounting Parts

1.
28426
620.997.0590

2.
27435
970.492.0441

3.
00940
071.555.090.501
395.492.0040
645.492.1140

4.
00608T

5.
28061
674.492.0040





6.
27497
970.490.0041

7.
27430
970.492.0130

Vertical
LHD
Standard

Series ATEGO

Type

- Euro II
- 18 ton. →
-  **OM 906**
- 6,37 ltr.
- 6 cyl.
- 170K W/231H P
- 205K W/279H P
-  **1823**
- 1828**
- 1828A**
- 2628**
-  **1823L**
- 1828L**
- 2523L**
- 2528L**
-  **1823 LS**
- 1828 LS**
-  **1823K**
- 1828K**
- 2628K**

Baumuster

- 950.501
- 950.502
- 950.503
- 950.504
- 950.505
- 950.506
- 950.507
- 950.508
- 950.509
- 950.531
- 950.532
- 950.533
- 950.534
- 950.535
- 950.536
- 950.537
- 950.538
- 950.539
- 950.602
- 950.603
- 950.604
- 950.605
- 950.623
- 950.624
- 950.625
- 950.626
- 950.642
- 950.643
- 952.502
- 952.503
- 952.562
- 952.563
- 952.641
- 952.642
- 952.643
- 953.641
- 953.643
- 954.532

Front pipeT

25781
940.490.0519
940.492.0159
940.490.1019

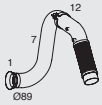

25754
940.490.0419
940.490.0919

High engine position
BM 950.562, 563
BM 952.562, 563

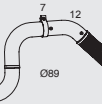

25785
940.492.0401
940.492.1601

 ADR

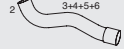

25752
940.492.1101
940.492.1901

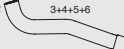

Silencer

27581
940.490.0301

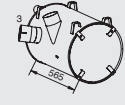

27585
940.490.0401

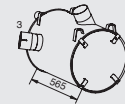

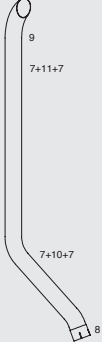

ail pipe

25931
940.492.0004





25932
940.492.0204

 Extended backw all



21363
940.492.0704

 Staggered tail pipe



21362
940.492.0104



Mounting Parts

1.
28426
620.997.0590



2.
27404
940.492.0040



3.
27400
940.490.0141



4.
00940
071.555.090.501
395.492.0040
645.492.1140



5.
27087
940.490.0041



6.
27086
940.492.0130



7.
08786
645.492.0118
346.492.0040



8.
00981
071.555.104.501
940.492.0240



9.
00986
655.492.0140
071.555.124.501



10.
27072
387.490.0030



11.
27073
655.490.0130



12.
27080
940.492.0230



Vertical
LHD
Standard

Series ATEGO

Type

Euro II

OM 906
6,37 ltr.
6 cyl.
170K W/231H P
205K W/279H P



1823
1828
1828A
2628



1823L
1828L
2523L
2528L



1823 LS
1828 LS



1823K
1823A K
1828K
1828A K
2628K



2628B

Baumuster

950.501 953.643
950.502 954.532
950.503
950.504
950.505
950.506
950.507
950.508
950.509
950.531
950.532
950.533
950.534
950.535
950.536
950.537
950.538
950.539
950.544
950.546
950.547
950.562
950.563
950.602
950.603
950.604
950.605
950.613
950.614
950.623
950.624
950.625
950.626
950.642
950.643
952.502
952.503
952.562
952.563
952.641
952.642
952.643
953.641

Vertical
LHD
Standard

Front pipe

25781
940.490.0519
940.492.0159
940.490.1019
 Low engine position

25712
940.492.0901
940.490.0619
940.492.1701

25754
940.490.0419
940.490.0919
 High engine position

25751
940.492.1001
490.492.1801
940.492.1801

Silencer

27587
973.490.0401

27071
970.491.0130

Tail pipe

25937
973.492.0014

Mounting Parts

1.
28426
620.997.0590

2.
28061
674.492.0040

3.
00901
071.555.094.502

4.
27075
940.490.0042

5.
27404
940.492.0040

6.
00940
071.555.090.501
395.492.0040
645.492.1140

7.
27400
940.490.0141

Series ATEGO

Type

Euro III
 OM 904L A
 4,25 ltr.
 4 cyl.

917K O
 1017K O
 1217K O
 1317K O

1317L KO

Baumuster

975.031
 975.041
 975.052
 975.062
 975.262

Front pipe

25724
 970.490.0819

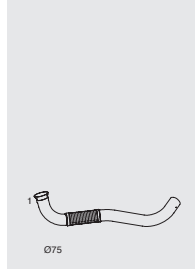

Silencer

28104
 375.490.0001
 970.490.0301

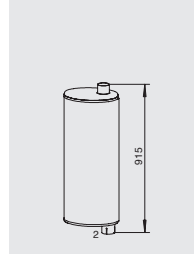

Tail pipe

27071
 970.491.0130

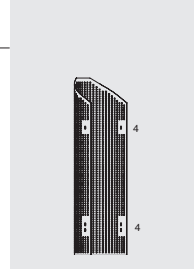

25936
 970.492.0014

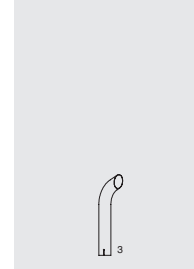

Mounting Parts

1.
28478
 620.997.0490

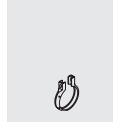

2.
28012
 668.492.0340

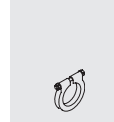

3.
28063
 673.492.0140
 313.392.0340

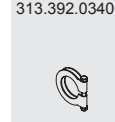

4.
27075
 940.490.0042



Vertical
 LHD
 Standard

Series ATEGO

Type

Euro II

OM 906L A
6,37 ltr.
6 cyl.
170K W/231H P

1523K O

1323L KO

Baumuster

975.072

975.262

Front pipeT

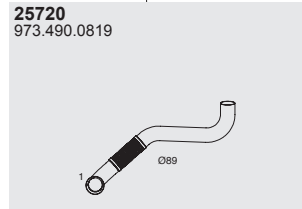

Silencer

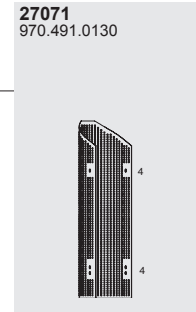
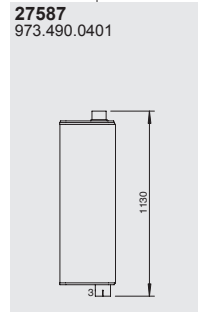

ail pipe

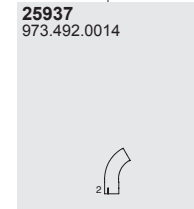

Mounting Parts

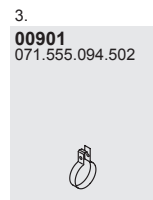
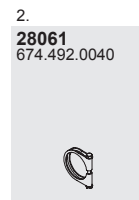
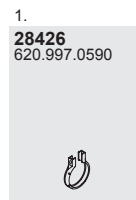

Vertical
LHD
Standard

Series AXOR

Type

Euro III

 **1823 - 1833**

 **1823L - 1833L**
2528L - 2533L

 **1823K - 1833K**

 **1823LS- 1833LS**

Baumuster

- 950.501
- 950.502
- 950.503
- 950.504
- 950.505
- 950.506
- 950.507
- 950.508
- 950.509
- 950.531
- 950.532
- 950.533
- 950.534
- 950.535
- 950.536
- 950.537
- 950.538
- 950.539
- 950.544
- 950.546
- 950.547
- 950.613
- 950.614
- 952.502
- 952.503
- 954.532

Front pipe

25781
940.490.0519
940.492.0159
940.490.1019
Low mounted engine.
(R6)

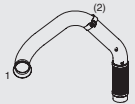

21708
944.490.0919
944.490.1919
940.490.1919
High mounted engine.



21707
944.490.1019
940.490.1819
OM926LA, low mounted engine.



25785
940.492.0401
940.492.1601
ADR(GGVS)

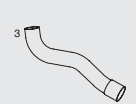

25752
940.492.1101
940.492.1901

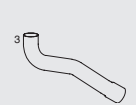

Silencer

28107
940.490.0101
Road vehicle

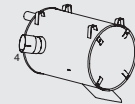

27554
940.490.0501
Constructions ite vehicle

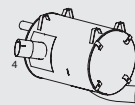

27586
940.490.0601
ADR(GGVS)

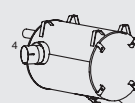

Mounting Parts

1.
28426
620.997.0590



2.
00940
071.555.090.501
395.492.0040
645.492.1140



3.
28061
674.492.0040







4.
00986
655.492.0140
071.555.124.501



Horizontal
LHD/RHD
Standard

Series AXOR

Type

Euro III
 Longl ength cab

1823 - 1833

1823L - 1833L
2528L - 2533L

1823K - 1833K

1823LS- 1833LS

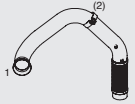
Baumuster

950.501
 950.502
 950.503
 950.504
 950.505
 950.506
 950.507
 950.508
 950.509
 950.531
 950.532
 950.533
 950.534
 950.535
 950.536
 950.537
 950.538
 950.539
 950.544
 950.546
 950.547
 950.613
 950.614
 952.502
 952.503
 954.532

Front pipe

25781
 940.490.0519
 940.492.0159
 940.490.1019
 Lowm ounted engine (R6).



21686
 930.492.3301
 300m moffsett oward rear.

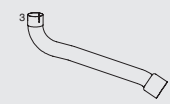

21707
 944.490.1019
 940.490.1819
 OM 926L A, low mounted engine.



25752
 940.492.1101
 940.492.1901



21708
 944.490.0919
 944.490.1919
 940.490.1919
 High mounted engine.

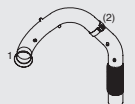

Silencer

27585
 940.490.0401

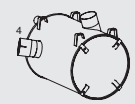

Tail pipe

21323
 930.490.0021



Mounting Parts

1.
28426
 620.997.0590



2.
00940
 071.555.090.501
 395.492.0040
 645.492.1140



3.
28061
 674.492.0040



4.
00986
 655.492.0140
 071.555.124.501



5.
00958
 645.492.0440
 071.555.130.500
 942.492.0140



Vertical
 LHD/RHD
 Standard

Series AXOR

Type

Euro III

 1823-1833

 1823K - 1833K

Baumuster

- 950.501
- 950.502
- 950.503
- 950.504
- 950.505
- 950.506
- 950.507
- 950.508
- 950.509
- 952.502
- 952.503

Front pipe

25781
940.490.0519
940.492.0159
940.490.1019
Lowm ounted engine(R6)

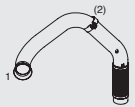

21708
944.490.0919
944.490.1919
940.490.1919
Highm ounted engine



25712
940.492.0901
940.490.0619
940.492.1701



21707
944.490.1019
940.490.1819
OM 926L A, lowm ounted engine

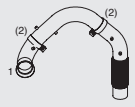

25751
940.492.1001
490.492.1801
940.492.1801



25700
944.490.0519
944.490.1319
Lowm ounted engine



21684
944.492.0401

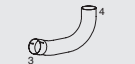

Silencer

27587
973.490.0401



Tail pipe

25937
973.492.0014



Mounting Parts

1.
28426
620.997.0590



2.
00940
071.555.090.501
395.492.0040
645.492.1140



3.
28061
674.492.0040



4.
00901
071.555.094.502



Vertical
LHD/RHD
Standard

Series AXOR

Type

Euro III
 Short length cab
 Medium length cab
 1823 - 1833
 1823L - 1833L
 2528L - 2533L
 1823K - 1833K
 1823LS- 1833LS

Baumuster

950.501
 950.502
 950.503
 950.504
 950.505
 950.506
 950.507
 950.508
 950.509
 950.531
 950.532
 950.533
 950.534
 950.535
 950.536
 950.537
 950.538
 950.539
 950.544
 950.546
 950.547
 950.613
 950.614
 952.502
 952.503
 954.532

Front pipe

25781
 940.490.0519
 940.492.0159
 940.490.1019
 Low mounted engine (R6)



21686
 930.492.3301
 300mm offset toward rear

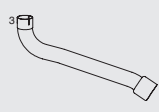

21707
 944.490.1019
 940.490.1819
 OM 926L A, low mounted engine



25785
 940.492.0401
 940.492.1601
 ADR(GGVS)



21708
 944.490.0919
 944.490.1919
 940.490.1919
 High mounted engine



Silencer

27581
 940.490.0301



Tail pipe

21331
 930.492.0904



21324
 930.492.0604



21335
 930.492.0304



Mounting Parts

1.
28426
 620.997.0590



2.
00940
 071.555.090.501
 395.492.0040
 645.492.1140



3.
20861
 674.492.0040



4.
00986
 655.492.0140
 071.555.124.501



5.
00958
 645.492.0440
 071.555.130.500
 942.492.0140







Vertical
 LHD/RHD
 Standard

Series AXOR

Type

Euro III

-  ④X②
-  ⑥X②
-  ⑥X②/③
-  ⑥X②/④
- 18 ton.
- 25 ton.

1831 L-1843 L
2531 L-2535 L

-  ⑥X④
- 26 ton.
- 33 ton.

2631 B-2643 B
3331 B-3343 B

 OM 926L A
7,2l tr.
6 cyl.
240K W/326H P

 OM 457L A
11,97l tr.
6 cyl.
265K W/360H P
295K W/401H P
315K W/428H P

Horizontal
LHD/RHD
Standard

Baumuster

- 950.044
- 950.046
- 950.047
- 950.213
- 950.214
- 950.218
- 953.141
- 953.161
- 953.162
- 953.163

Front pipe

25626
942.490.3019
942.490.4119

ID No. 409485 →
BM 953.xxx

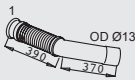

25757
942.490.2419

ID No. 409485 →
BM 950.xxx



21735
942.490.1019
942.490.2019

→ ID No. 409484

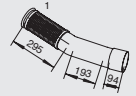

25692
942.490.3619
948.490.4719

ID No. 409485 →
BM 950.xxx

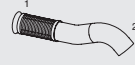

21704
942.490.3519
942.490.2119

→ ID No. 409484
BM 950.xxx



Silencer

28128
942.490.2601
942.490.3701
942.490.2701
Road version

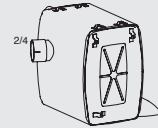

28126
942.490.1601
942.490.2801

BM 950.044,046,213,214

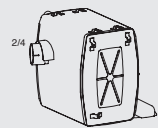

28121
942.490.3501
942.490.2101
942.490.1501
Constructions ite version

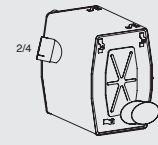

25625
942.490.2119
942.490.1119
942.492.3301



21681
942.492.1101



Mounting Parts

1.
27401
942.997.0290



2.
00958
645.492.0440
071.555.130.500
942.492.0140



3.
00969
071.555.124.501
655.492.01401



4.
28049
942.490.0341
942.490.0041



Series AXOR

Type

Euro III



25 ton.

2535 L-2543 L



18 ton.
25 ton.

1835 LS-1843L S
2535 LS-2543L S

OM 457L A
12,0l tr.
6 cyl.
260K W/354H P
295K W/401H P
315K W/428H P

Baumuster

940.203
940.204
940.205
944.032
944.033
944.233

Front pipe

21747
941.490.0219

K 766382 ▶CHno
B 950018 ▶CHno

21794
375.490.2619

21745
941.490.0419

21685
941.492.0301
941.490.0619

21746
941.490.0319

K 766383 ▶CHno
B 950019 ▶CHno

21741
941.490.0919
941.490.0719

21682
944.492.0201

Silencer

28128
942.490.2601
942.490.3701
942.490.2701
Road version

28121
942.490.3501
942.490.2101
942.490.1501
Constructions ite version

28126
942.490.1601
942.490.2801
V8, GGVS

Mounting Parts

1.
27401
942.997.0290

2.
00971
071.555.114.500

3.
00958
645.492.0440
071.555.130.500
942.492.0140

4.
00969
071.555.124.501
655.492.01401

5. Excl.B M 940.203,205
21748
941.490.0165

Repair solution

Horizontal
LHD/RHD
Standard

Series AXOR

Type

Euro III

 18,2 0t on.
25,2 6t on.
33 ton.

1831-1843
1831 L-1843 L
2031
2031A , 2035A
2040
2531-2543
2531 L-2543 L
2631-2643
2631 L-2643 L
3331-3343
3331A , 3340A

 18,2 0t on.
26,3 3t on.
1831 K-1843 K
1831 AK-1843 AK
2031K
2031 AK-2040 AK
2631 K-2643 K
2640 LK-2643 LK
3331 K-3343 K
3331 AK-3343 AK

 OM 926L A
7,2l tr.
6 cyl.
240K W/326H P

 OM 457L A
12,0l tr.
6 cyl.
265K W/360H P
295K W/401H P
315K W/428H P

Horizontal
LHD/RHD
Standard

Baumuster

950.003 952.143
950.004 952.161
950.005 952.162
950.006 952.163
950.007 952.182
950.008 952.183
950.013 952.241
950.014 952.243
950.016
950.031
950.033
950.034
950.035
950.036
950.037
950.038
950.083
950.113
950.114
950.142
950.143
950.145
950.162
950.182
950.183
950.203
950.204
950.205
950.208
950.223
950.224
950.225
950.226
950.242
952.002
952.003
952.013
952.072
952.073
952.083
952.141
952.142

Front pipe

21742
942.490.2319
→ ID No. 409484
Excl.B M 950.223-226



21735
942.490.1019
942.490.2019
→ ID No.409484

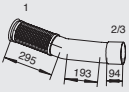

25757
942.490.2419
→ ID No. 409484
Excl.B M 950.223-226



21761
942.490.3119
942.490.4219
ID No. 409485 →
Excl.B M 950.223-226



25626
942.490.3019
942.490.4119
ID No. 409485 →



25717
942.490.3219
942.490.4319
ID No. 409485 →
Excl.B M 950.223-226
Excl.B M 952.002, 142

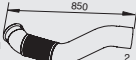

25621
942.490.2219
942.490.1219
942.490.4019
BM 950.004,006,014,031,033,
034,036,113,114,143,162,163,
203,204,205,242-244
952.003
BM 952.003,072,073,141,143,
161,163,182,183,241,243

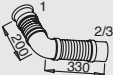

Silencer

28128
942.490.2601
942.490.3701
942.490.2701
Road version



28121
942.490.3501
942.490.2101
942.490.1501
Constructions ite version

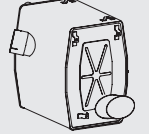

28126
942.490.1601
942.490.2801
V8, GGVS
Excl.B M
950.083,182,183,209



Mounting Parts

1.
27401
942.997.0290



2.
28049
942.490.0341
942.490.0041



3.
28044
942.490.0441



4.
00958
645.492.0440
071.555.130.500
942.492.0140



Series AXOR

Type

Euro III

 25 ton.

2535 L-2543 L

 25 ton.
④ X ②
⑥ X ②

25 ton.

 OM 457L A
12,0l tr.
6 cyl.
260K W/354H P
295K W/401H P
315K W/428H P

Baumuster

940.203

940.204

940.205

Front pipe

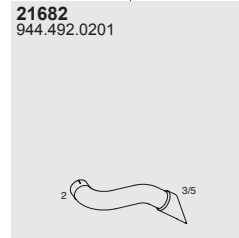
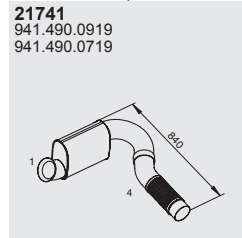
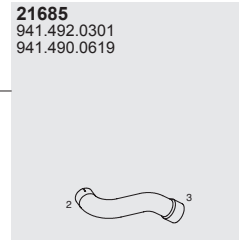

Silencer

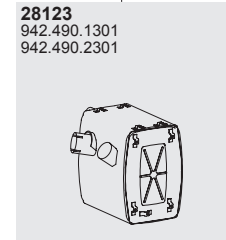

Tail pipe

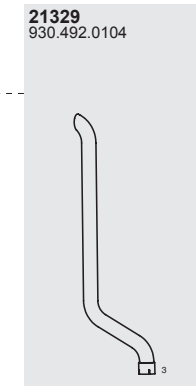
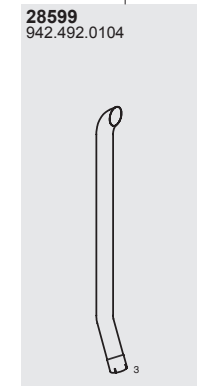
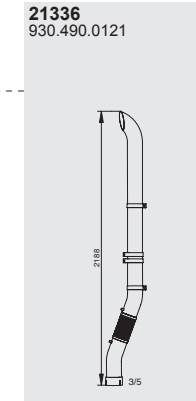
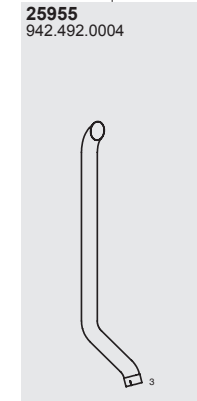

Mounting Parts

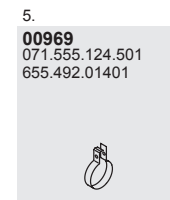
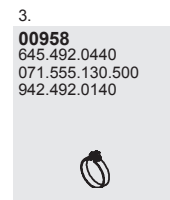
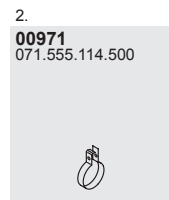

Vertical
LHD/RHD
Standard

Series AXOR

Type

Euro III

 25 ton.

2535 L-2543 L





25 ton.

OM 457L A
 12,0l tr.
 6 cyl.
 260K W/354H P
 295K W/401H P
 315K W/428H P

Baumuster

940.203
 940.204
 940.205

Front pipe

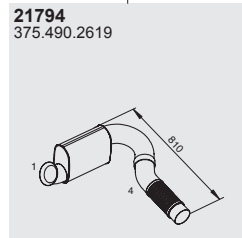
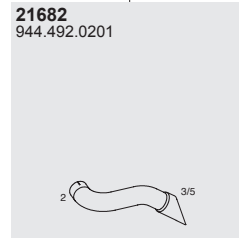
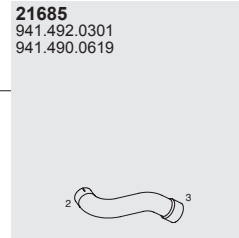

Silencer

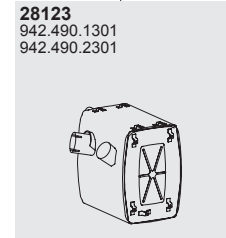

Tail pipe

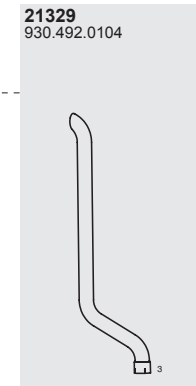
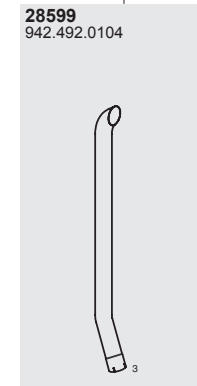
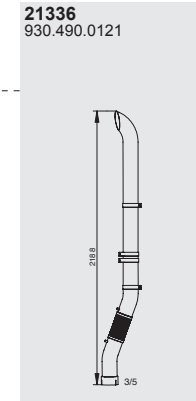
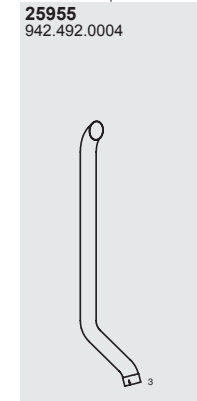

Mounting Parts

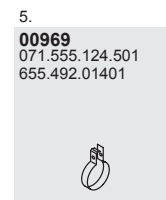
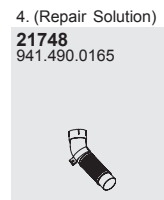
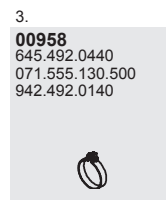
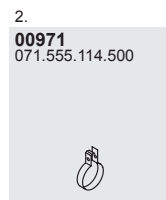

Vertical
 LHD/RHD
 Standard

Series AXOR

Type

Euro III



18 ton.
20 ton.
25 ton.
26 ton.
33 ton.

1831-1843
1835L
1831L -1843L
2031
2040
2531L -2543L
3331-3343
2031A
3340A
3331A
2631-2343
2531-2543
2035A
2631L -2643L

OM 457L A
12 ltr.
6 cyl.
260K W/354H P
295K W/401H P
315K W/428H P

OM 926L A
7.2l tr.
6 cyl.
240K W/326H P

Baumuster

950.003
950.004
950.005
950.006
950.007
950.008
950.013
950.014
950.016
950.031
950.033
950.034
950.035
950.036
950.037
950.038
950.083
950.113
950.114
950.142
950.143
950.145
950.162
950.163
950.182
950.183
950.203
950.204
950.205
950.208
950.223
950.224
950.225
950.226
950.242

Front pipe

25621
942.490.2219
942.490.1219
942.490.4019
950.004/006/014/031/033/
034/036/113/114/143/162/
163/203/204/205/242/243/244

25626
942.490.3019
942.490.4119
→ ID NR.: 409484
Excl. 950.223/224/225/226

21742
942.490.2319
→ ID NR.: 409484
Excl. 950.223/224/225/226

25717
942.490.3219
942.490.4319
ID NR.: 409485 →
Excl. 950.223/224/225/226

25763
942.490.2819
950.006/014/034/036/113/
114/143/162/163/203/204/
205/242/243/244

21735
942.490.1019
942.490.2019
→ ID NR.: 409484

21781
942.490.3119
942.490.4219
Excl. 950.044/223/224/225/226

25757
942.490.2419
→ ID NR.: 409484
Excl. 95223/224/225/226

Silencer

28129
942.490.3401
942.490.1401

Tail pipe

25984
942.492.0404

21361
942.492.0504
Excl.
950.223/224/225/226

Mounting Parts

1.
27401
942.997.0290

2.
28049
942.490.0341
942.490.0041

3.
28044
942.490.0441

4.
00958
645.492.0440
071.555.130.500
942.492.0140

Vertical
LHD/RHD
Standard

Series AXOR

Type

Euro III



18 ton.
20 ton.
25 ton.
26 ton.
33 ton.

1831-1843
1835L
1831L -1843L
2031
2040
2531L -2543L
3331-3343
2031A
3340A
3331A
2631-2343
2531-2543
2035A
2631L -2643L

OM 457L A
12 ltr.
6 cyl.
260K W/354H P
295K W/401H P
315K W/428H P

OM 926L A
7.2l tr.
6 cyl.
240K W/326H P

Baumuster

950.003
950.004
950.005
950.006
950.007
950.008
950.013
950.014
950.016
950.031
950.033
950.034
950.035
950.036
950.037
950.038
950.083
950.113
950.114
950.142
950.143
950.145
950.162
950.163
950.182
950.183
950.203
950.204
950.205
950.208
950.223
950.224
950.225
950.226
950.242

Front pipe

25621
942.490.2219
942.490.1219
942.490.4019
950.004/006/014/031/033/
034/036/113/114/143/162/
163/203/204/205/242/243/244

25626
942.490.3019
942.490.4119
→ ID NR.: 409484
Excl. 950.223/224/225/226

21742
942.490.2319
→ ID NR.: 409484
Excl. 950.223/224/225/226

25717
942.490.3219
942.490.4319
ID NR.: 409485 →
Excl. 950.223/224/225/226

25763
942.490.2819
950.006/014/034/036/113/
114/143/162/163/203/204/
205/242/243/244

21735
942.490.1019
942.490.2019
→ ID NR.: 409484

21781
942.490.3119
942.490.4219
Excl. 950.044/223/224/225/226

25757
942.490.2419
→ ID NR.: 409484
Excl. 95223/224/225/226

Silencer

28129
942.490.3401
942.490.1401

Tail pipe

25984
942.492.0404

21361
942.492.0504
Excl.
950.223/224/225/226

Mounting Parts

1.
27401
942.997.0290

2.
28049
942.490.0341
942.490.0041

3.
28044
942.490.0441

4.
00958
645.492.0440
071.555.130.500
942.492.0140

Vertical
LHD/RHD
Standard

Series ACTROS

Type

Euro II/III



18/20/26/33 ton.

OM 501L A
230K W/313H P
260K W/354H P
290K W/394H P
315K W/428H P

OM 502L A
350K W/476H P
390K W/530H P

1831LS-1848LS
2031AS-2051A S
2031S-2055S
2631-2655
2631L-2651L
2631 LS-2660LS
3331-3355
3331-3360
3331AS-3355AS
3331S-3355S
4141

WB
3300,3600,3900,
4200,4500,4800,
6300

Baumuster

930.143
930.162
930.163
930.243
930.244
930.319
934.012
934.013
934.082
934.141
934.161
934.182
934.241

Front pipe

25621
942.490.2219
942.490.1219
942.490.4019
V8, GGVS



25726
942.490.2719
OM 502
Excl. 934.082/182/241



25763
942.490.2819
V8, GGVS
Excl. 934.082/182/241



21613
930.490.5519
V8,2 30 L



25625
942.490.2119
942.490.1119
942.492.3301

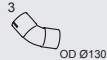

Silencer

28128
942.490.2601
942.490.3701
942.490.2701
V8
Road version

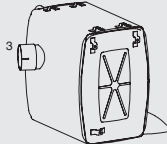

28121
942.490.3501
942.490.2101
942.490.1501
Constructions ite version

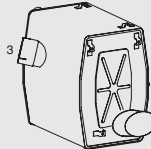

28126
942.490.1601
942.490.2801
V8, GGVS

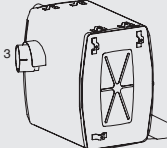

Mounting Parts

1.
28043
942.997.0090



2.
27401
942.997.0290



3.
00958
645.492.0440
071.555.130.500
942.492.0140



Horizontal
LHD/RHD
Standard

Series ACTROS

Type

Euro II/III

4X2 6X4 6X6

4X2 4X4 6X4 6X6

18/20/26/33 ton.

OM 501L A
230K W/313H P
260K W/354H P
290K W/394H P
315K W/428H P

OM 502L A
350K W/476H P
390K W/530H P
420K W/571H P

1831LS-1848LS
2031-2048
2031AS-2051AS
2031S-2055S
2032A
2036A
2631-2655
2631L-2660L
2631LS-2660LS
3331-3360
3331A-3348A
3331AS-3355AS
3331S-3355S
4141

WB
3300,3600,3900,
4200,4500,4800,
5100,5400,6300

Horizontal
LHD/RHD
Standard

Baumuster

930.013
930.014
930.016
930.083
930.142
930.143
930.145
930.162
930.163
930.182
930.183
930.242
930.243
930.244
930.319
934.012
934.013
934.082
934.141
934.161
934.182
934.241

Front pipe

25626
942.490.3019
942.490.4119

V6

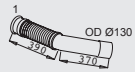

21619
930.490.5419

V6,2 30 L

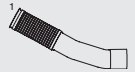

21611
930.490.0419

V6

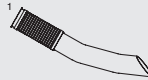

21781
942.490.3119
942.490.4219

OM 501
Excl.B M 934.241

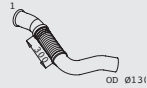

25717
942.490.3219
942.490.4319

L, V 6
Excl.B M 934.241



25625
942.490.2119
942.490.1119
942.492.3301

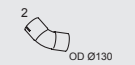

Silencer

28128
942.490.2601
942.490.3701
942.490.2701

V8
Road version

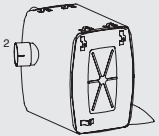

28121
942.490.3501
942.490.2101
942.490.1501

Constructions ite version

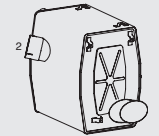

28126
942.490.1601
942.490.2801

V8, GGVS
Excl.B M 930.083/182/183
BM 934.082/182

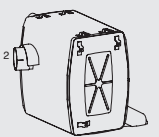

Mounting Parts

1.
27401
942.997.0290



2.
00958
645.492.0440
071.555.130.500
942.492.0140



Series ACTROS

Type

Euro II/III

- 1831
- 1835/ L
- 1840/ A/L
- 1843/ L
- 1848
- 2031
- 2035/ A
- 2040
- 2053
- 2531
- 2535/ L
- 2540/ L
- 2543/ L
- 2548
- 2553
- 2631
- 2635
- 2640
- 2643
- 2648
- 2653
- 3231
- 3235
- 3240
- 3243
- 3331
- 3335
- 3340/ A
- 3343
- 3348
- 4140
- 4143
- 4148

- 2040 AS

- 1831 AK/K
- 2040A K
- 3343A K
- 4143A K

Horizontal
LHD
Standard

Baumuster

- | | |
|---------|---------|
| 950.003 | 950.244 |
| 950.004 | 950.306 |
| 950.005 | 952.002 |
| 950.006 | 952.003 |
| 950.007 | 952.013 |
| 950.008 | 952.072 |
| 950.013 | 952.073 |
| 950.014 | 952.083 |
| 950.016 | 952.141 |
| 950.031 | 952.142 |
| 950.032 | 952.143 |
| 950.033 | 952.161 |
| 950.034 | 952.162 |
| 950.035 | 952.163 |
| 950.036 | 952.182 |
| 950.037 | 952.183 |
| 950.038 | 952.242 |
| 950.044 | 952.243 |
| 950.046 | 952.304 |
| 950.047 | 952.305 |
| 950.056 | 952.307 |
| 950.057 | 952.314 |
| 950.083 | 952.315 |
| 950.113 | 952.317 |
| 950.114 | 952.325 |
| 950.145 | 952.336 |
| 950.162 | 954.002 |
| 950.163 | 954.003 |
| 950.182 | 954.012 |
| 950.183 | 954.032 |
| 950.203 | 954.033 |
| 950.204 | 954.042 |
| 950.205 | 954.053 |
| 950.208 | 954.062 |
| 950.213 | 954.082 |
| 950.214 | 954.141 |
| 950.218 | 954.161 |
| 950.223 | 954.182 |
| 950.224 | 954.223 |
| 950.225 | 954.233 |
| 950.226 | 954.241 |
| 950.242 | |
| 950.243 | |

Front pipe

25626
942.490.3019
942.490.4119

OM 501, V6
Standard

21735
942.490.1019
942.490.2019

OM 501, V6, ADR
Standard

21781
942.490.3119
942.490.4219

OM 501.V 6

25692
942.490.3619
948.490.4719

OM 501, V6
Jumbo
AirS uspension
BM 950.044, 046, 213, 214, 218
BM 954.042

25625
942.490.2119
942.490.1119
942.492.3301

Jumbo

25757
942.490.2419

OM 501, V6
►CHno 409.484

25717
942.490.3219
942.490.4319

OM 501, V6
►CHno 409.484 ►CHno

25621
942.490.2219
942.490.1219
942.490.4019

OM 502, V8

25763
942.490.2819

OM 502, V8, ADR
High cab

Silencer

28128
942.490.2601
942.490.3701
942.490.2701

Road version
V6, V8

28121
942.490.3501
942.490.2101
942.490.1501

Constructions ite version

28126
942.490.1601
942.490.2801

ADR

27401
942.997.0290

Mounting Parts

1.
28043
942.997.0090

2A.
28049
942.490.0341
942.490.0041

2B.
28044
942.490.0441

3.
00958
645.492.0440
071.555.130.500
942.492.0140

Series ACTROS

Type

Baumuster

Euro II/III

930.143



930.162



930.243



930.244



930.319



934.012



934.013



934.082

934.141

18/20/26/33 ton.

934.161



934.182

OM 501L A
230K W/313H P
260K W/354H P
290K W/394H P
315K W/428H P

934.241



1831LS-1848LS
2031AS-2051A S
2031S-2055S
2631-2655
2631L-2651L
2631 LS-2660LS
3331-3355
3331-3360
3331AS-3355AS
3331S-3355S
4141

WB
3300,3600,3900,
4200,4500,4800,
6300

Page 1/2
Next page:
(syst. 150001007)

Vertical
LHD/RHD
Standard

Front pipe

Silencer

25621
942.490.2219
942.490.1219
942.490.4019
V8, GGVS



25726
942.490.2719
OM 502
Excl.
934.082/182/241



28123
942.490.1301
942.490.2301



21613
930.490.5519
V8,2 30 L

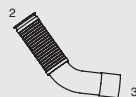

Mounting Parts

1.
28043
942.997.0090



2.
27401
942.997.0290



3.
00958
645.492.0440
071.555.130.500
942.492.0140



Series ACTROS

Type

Euro II/III



18/20/26/33 ton.

OM 501L A

230K W/313H P
260K W/354H P
290K W/394H P
315K W/428H P

OM 502L A

350K W/476H P
390K W/530H P

1831LS-1848LS
2031AS-2051A S
2031S-2055S
2631-2655
2631L-2651L
2631 LS-2660LS
3331-3355
3331-3360
3331AS-3355AS
3331S-3355S
4141

WB
3300,3600,3900,
4200,4500,4800,
6300

Page 2/2
Previous page:
(syst. 150001006)

Vertical
LHD/RHD
Standard

Baumuster

930.143
930.162
930.163
930.243
930.244
930.319
934.012
934.013
934.082
934.141
934.161
934.182
934.241

Silencer

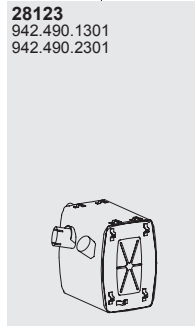

28123
942.490.1301
942.490.2301

Tail pipe

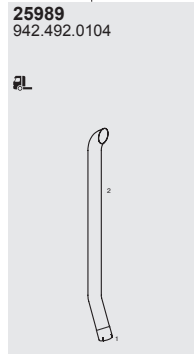

25989
942.492.0104

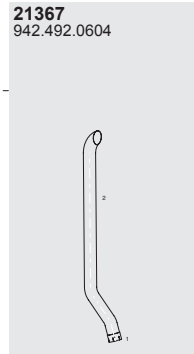

21367
942.492.0604

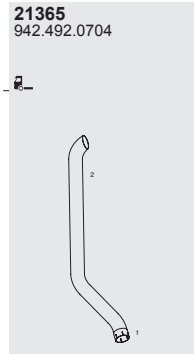

21365
942.492.0704

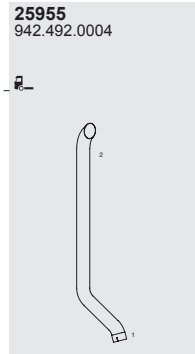

25955
942.492.0004

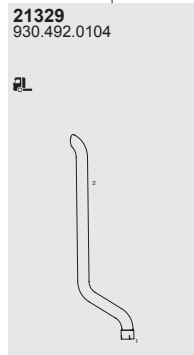

21329
930.492.0104

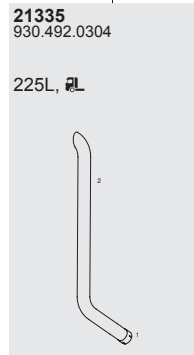

21335
930.492.0304

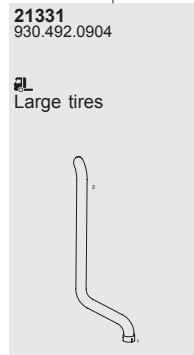

21331
930.492.0904

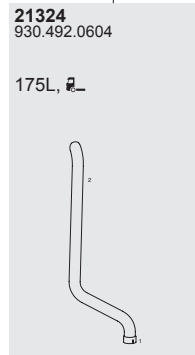

21324
930.492.0604

Mounting Parts

1.
00958
645.492.0440
071.555.130.500
942.492.0140



2.
27442
942.490.0141



Series ACTROS

Type Baumuster

Euro II/III
 930.013
 930.014
 930.016
 930.083
 930.142
 930.143
 930.145
 930.162
 930.163
 930.182
 930.183
 930.242
 930.243
 930.244
 930.319
 934.012
 934.013
 934.082
 934.141
 934.161
 934.182
 934.241
 18/20/26/33 ton.
 930.183
 930.242
 930.243
 930.244
 930.319
 934.012
 934.013
 934.082
 934.141
 934.161
 934.182
 934.241
 1831LS-1848LS
 2031-2048
 2031AS-2051AS
 2031S-2055S
 2032A
 2036A
 2631-2648
 2631-2655
 2631L-2660L
 2631LS-2660LS
 3331-3360
 3331A-3348A
 3331AS-3355AS
 3331S-3355S
 4141
 WB
 3300,3600,3900,
 4200,4500,4800,
 5100,5400,6300

Page 1/2
 Next page:
 (syst. 150001012)

Vertical
 LHD/RHD
 Standard

Front pipe

Silencer

25626
 942.490.3019
 942.490.4119
 V6

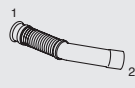

21619
 930.490.5419
 V6,2 30 L

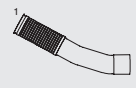

21781
 942.490.3119
 942.490.4219
 OM 501
 Excl.B M 934.241



28123
 942.490.1301
 942.490.2301



25717
 942.490.3219
 942.490.4319
 V6
 Excl.B M 934.241



21611
 930.490.0419
 V6

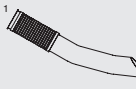

Mounting Parts

1.
27401
 942.997.0290



2.
00958
 645.492.0440
 071.555.130.500
 942.492.0140



Series ACTROS

Type

Euro II/III



18/20/26/33 ton.

OM 501L A
230K W/313H P
260K W/354H P
290K W/394H P
315K W/428H P

OM 502L A
350K W/476H P
390K W/530H P
420K W/571H P

1831LS-1848LS
2031-2048
2031AS-2051AS
2031S-2055S
2032A
2036A
2631-2648
2631-2655
2631L-2660L
2631LS-2660LS
3331-3360
3331A-3348A
3331AS-3355AS
3331S-3355S
4141

WB
3300,3600,3900,
4200,4500,4800,
5100,5400,6300

Page 2/2
Previous page:
(syst. 150001009)

Vertical
LHD/RHD
Standard

Baumuster

930.013
930.014
930.016
930.083
930.142
930.143
930.145
930.162
930.163
930.182
930.183
930.242
930.243
930.244
930.319
934.012
934.013
934.082
934.141
934.161
934.182
934.241

Silencer

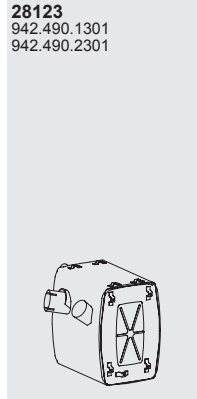

28123
942.490.1301
942.490.2301

Tail pipe

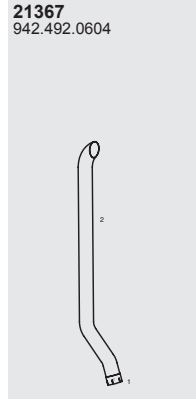

21367
942.492.0604

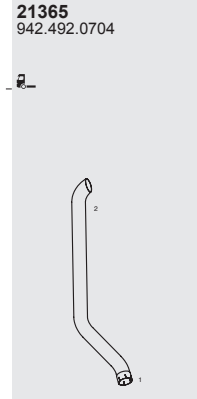

21365
942.492.0704

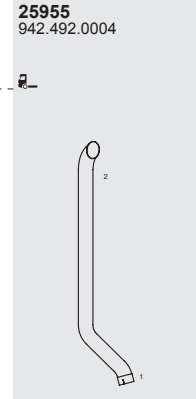

25955
942.492.0004

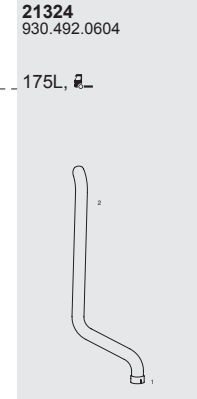

21324
930.492.0604

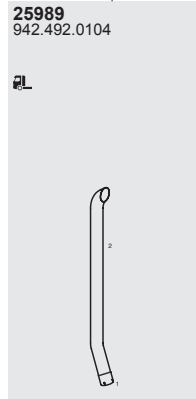

25989
942.492.0104

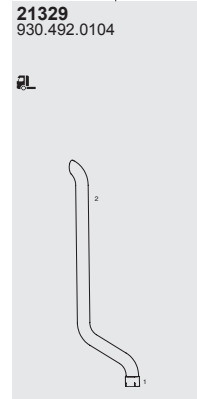

21329
930.492.0104

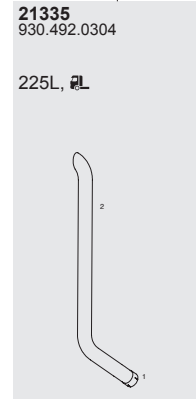

21335
930.492.0304

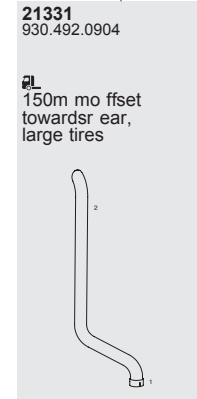

21331
930.492.0904

Mounting Parts

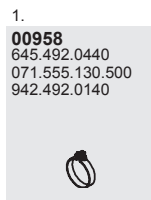

1.
00958
645.492.0440
071.555.130.500
942.492.0140



2.
27442
942.490.0141

Series ACTROS

Type

Euro II/III

- 1831
- 1835/ L
- 1840/ A/L
- 1843/ L
- 1848
- 2031
- 2035/ A
- 2040
- 2053
- 2531
- 2535/ L
- 2540/ L
- 2543/ L
- 2548
- 2553
- 2631
- 2635
- 2640
- 2643
- 2648
- 2653
- 3231
- 3235
- 3240
- 3243
- 3331
- 3335
- 3340/ A
- 3343
- 3348
- 4140
- 4143
- 4148

- 2040 AS

- 1831 AK/K
- 2040A K
- 3343A K
- 4143A K

Page 1/2
Next page:
(syst. 150101028)

Vertical
LHD
Standard

Baumuster

- | | |
|---------|---------|
| 950.003 | 950.242 |
| 950.004 | 950.243 |
| 950.005 | 950.244 |
| 950.006 | 950.306 |
| 950.007 | 952.002 |
| 950.008 | 952.003 |
| 950.013 | 952.013 |
| 950.014 | 952.072 |
| 950.016 | 952.073 |
| 950.031 | 952.083 |
| 950.032 | 952.141 |
| 950.033 | 952.142 |
| 950.034 | 952.143 |
| 950.035 | 952.161 |
| 950.036 | 952.162 |
| 950.037 | 952.163 |
| 950.038 | 952.182 |
| 950.044 | 952.183 |
| 950.046 | 952.241 |
| 950.047 | 952.243 |
| 950.056 | 952.304 |
| 950.057 | 952.305 |
| 950.083 | 952.307 |
| 950.113 | 952.314 |
| 950.114 | 952.315 |
| 950.142 | 952.317 |
| 950.143 | 952.325 |
| 950.145 | 952.336 |
| 950.162 | |
| 950.182 | |
| 950.183 | |
| 950.203 | |
| 950.204 | |
| 950.205 | |
| 950.208 | |
| 950.213 | |
| 950.214 | |
| 950.218 | |
| 950.223 | |
| 950.224 | |
| 950.225 | |
| 950.226 | |

Front pipe

25626
942.490.3019
942.490.4119

OM501,V 6
Standard

21735
942.490.1019
942.490.2019

OM501,V 6
Standard, ADR

21781
942.490.3119
942.490.4219

OM501,V 6

25692
942.490.3619
948.490.4719

OM501,V 6
Jumbo
AirS uspension
BM 950.044, 046, 213, 214, 218
BM 954.042

28129
942.490.3401
942.490.1401

25757
942.490.2419

OM501,V 6
▶CHno 409.484

25717
942.490.3219
942.490.4319

OM501,V 6
▶CHno 409.484

25625
942.490.2119
942.490.1119
942.492.3301

Jumbo

28123
942.490.1301
942.490.2301

25621
942.490.2219
942.490.1219
942.490.4019

OM502,V 8

25763
942.490.2819

OM502,V 8, ADR
High cab

Mounting Parts

1.
28043
942.997.0090

2A.
28049
942.490.0341
942.490.0041

2B.
28044
942.490.0441

3.
00958
645.492.0440
071.555.130.500
942.492.0140

4.
27401
942.997.0290

Series ACTROS

Type

Euro II/III

1831
1835/ L
1840/ A/L
1843/ L
1848
2031
2035/ A
2040
2053
2531
2535/ L
2540/ L
2543/ L
2548
2553
2631
2635
2640
2643
2648
2653
3231
3235
3240
3243
3331
3335
3340/ A
3343
3348
4140
4143
4148

2040 AS

1831 AK/K
2040A K
3343A K
4143A K

Page 2/2
Previous page:
(syst. 150101010)

Vertical
LHD
Standard

Baumuster

950.003 950.242
950.004 950.243
950.005 950.244
950.006 950.306
950.007 952.002
950.008 952.003
950.013 952.013
950.014 952.072
950.016 952.073
950.031 952.083
950.032 952.141
950.033 952.142
950.034 952.143
950.035 952.161
950.036 952.162
950.037 952.163
950.038 952.182
950.044 952.183
950.046 952.241
950.047 952.243
950.056 952.304
950.057 952.305
950.083 952.307
950.113 952.314
950.114 952.315
950.142 952.317
950.143 952.325
950.145 952.336
950.162
950.163
950.182
950.183
950.203
950.204
950.205
950.208
950.213
950.214
950.218
950.223
950.224
950.225
950.226

Silencer

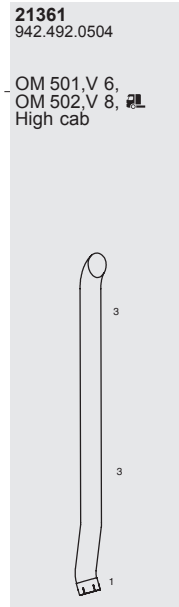
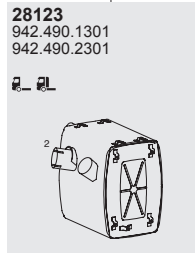
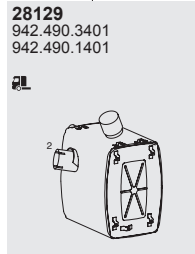

Tail pipe

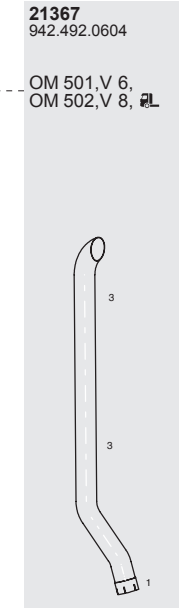
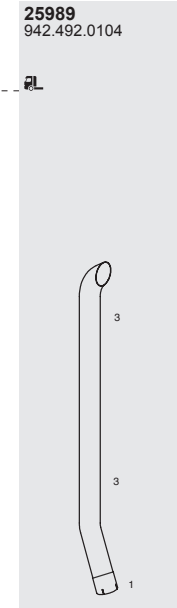
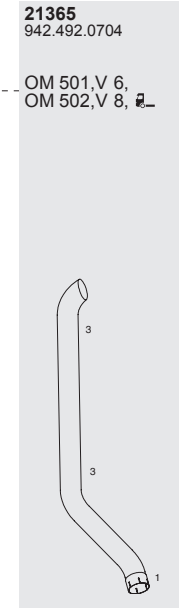
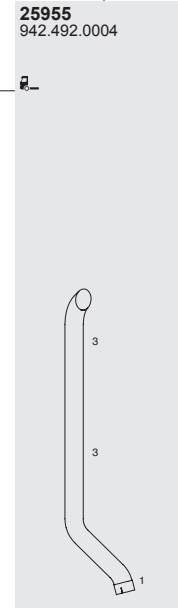

Mounting Parts

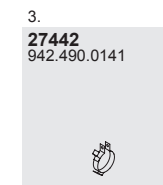
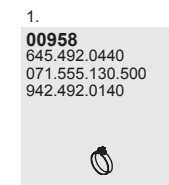

Series ACTROS

Type Baumuster

Euro II/III 953.141

 953.161

1831 953.163

1835/ L 954.002

1840/ A/L 954.003

1843/ L 954.012

1848 954.032

2031 954.033

2035/ A 954.042

2040 954.053

2053 954.062

2531 954.082

2535/ L 954.141

2540/ L 954.141

2543/ L 954.161

2548 954.182

2553 954.223

2631 954.233

2635 954.241

2640

2643

2648

2653

3231

3235

3240

3243

3331

3335

3340/ A

3343

3348

4140

4143

4148

 **2040 AS**

 **1831 AK/K**

2040A K

3343A K

4143A K

Page 1/2
Next page:
(syst. 150101034)

Vertical
LHD
Standard

Front pipe

25626
942.490.3019
942.490.4119

OM 501,V 6
Standard

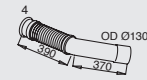

25692
942.490.3619
948.490.4719

OM 501,V 6
Jumbo
AirS suspension
BM 954.042

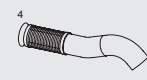

25757
942.490.2419

OM 501,V 6
▶CHno 409.484

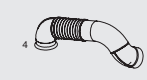

25621
942.490.2219
942.490.1219
942.490.4019
OM 502,V 8

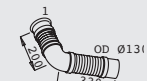

21735
942.490.1019
942.490.2019

OM 501,V 6
Standard, ADR

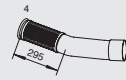

25625
942.490.2119
942.490.1119
942.492.3301
Jumbo



25717
942.490.3219
942.490.4319

OM 501,V 6
▶CHno 409.484



25763
942.490.2819

OM 502,V 8, ADR
▶CHno High cab



Silencer

28129
942.490.3401
942.490.1401

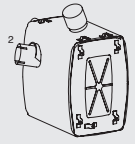

28123
942.490.1301
942.490.2301

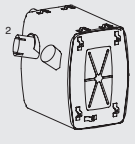

Mounting Parts

1.
28043
942.997.0090



2A. 
28049
942.490.0341
942.490.0041



2B. 
28044
942.490.0441



3.
00958
645.492.0440
071.555.130.500
942.492.0140



4.
27401
942.997.0290



Series ACTROS

Type Baumuster

Euro II/III 953.141

 953.143

1831 953.161

1835/ L 953.163

1840/ A/L 954.002

1843/ L 954.003

1848 954.012

2031 954.032

2035/ A 954.033

2040 954.042

2053 954.053

2531 954.062

2535/ L 954.082

2540/ L 954.141

2543/ L 954.141

2548 954.161

2553 954.182

2631 954.223

2635 954.233

2640 954.241

2643

2648

2653

3231

3235

3240

3243

3331

3335

3340/ A

3343

3348

4140

4143

4148

 1831 AK/K

2040A K

3343A K

4143A K

Page 2/2
Previous page:
(syst. 150101033)

Vertical
LHD
Standard

Silencer

28129
942.490.3401
942.490.1401

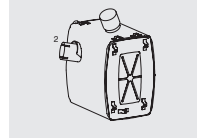

28123
942.490.1301
942.490.2301

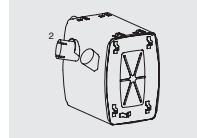

25984
942.492.0404

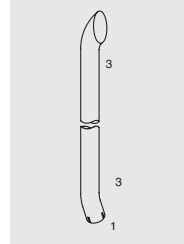

21361
942.492.0504

OM 501,V 6,
OM 502,V 8, 
High cab

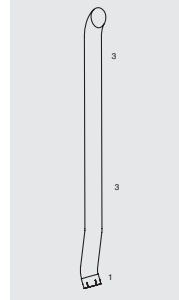

Tail pipe

25955
942.492.0004

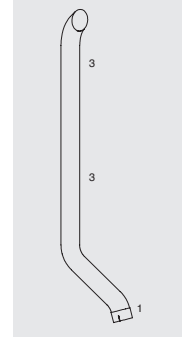

21365
942.492.0704

OM 501,V 6,
OM 502,V 8, 

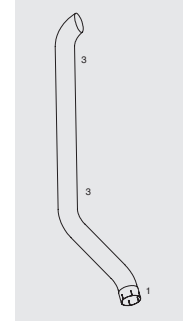

25989
942.492.0104

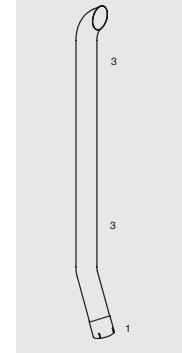

21367
942.492.0604

OM 501,V 6,
OM 502,V 8, 

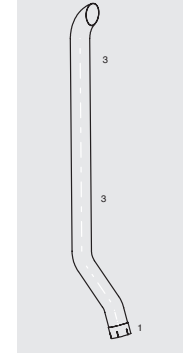

Mounting Parts

1.
00958
645.492.0440
071.555.130.500
942.492.0140



2A. 
28049
942.490.0341
942.490.0041



2B. 
28044
942.490.0441



3.
27442
942.490.0141



Series ACTROS

Type

Baumuster

Euro II/III



18/20/26/33 ton.

OM 501L A
230K W/313H P
260K W/354H P
290K W/394H P
315K W/428H P

OM 502L A
350K W/476H P
390K W/530H P

1831LS-1848LS
2031AS-2051AS
2031S-2055S
2631-2655
2631L-2651L
2631 LS-2660LS
3331-3355
3331-3360
3331AS-3355AS
3331S-3355S
4141

WB
3300,3600,3900,
4200,4500,4800.
6300

930.143
930.162
930.163
930.243
930.244
930.319
934.012
934.013
934.082
934.141
934.161
934.182
934.241

Front pipe

Silencer

Tail pipe

25621
942.490.2219
942.490.1219
942.490.4019
V8, GGVS



25726
942.490.2719
OM 502
Excl. 934.082/182/241



28129
942.490.3401
942.490.1401



21323
930.490.0021



25984
942.492.0404



21613
930.490.5519
V8, 230L



25763
942.490.2819
V8, GGVS
Excl. B M 934.082/182/241



21336
930.490.0121

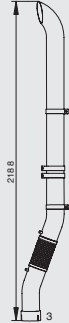

21361
942.492.0504



Mounting Parts

1.
28043
942.997.0090



2.
27401
942.997.0290



3.
00958
645.492.0440
071.555.130.500
942.492.0140



4.
27442
942.490.0141



Vertical
LHD/RHD
Standard

Series ACTROS

Type

Euro II/III

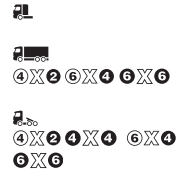

18/20/26/33 ton.

OM 501L A
230K W/313H P
260K W/354H P
290K W/394H P
315K W/428H P

OM 502L A
350K W/476H P
390K W/530H P
420K W/571H P

1831LS-1848LS
2031-2048
2031AS-2051AS
2031S-2055S
2032A
2036A
2631-2648
2631-2655
2631L-2660L
2631LS-2660LS
3331-3360
3331A-3348A
3331AS-3355AS
3331S-3355S
4141

WB
3300,3600,3900,
4200,4500,4800,
5100,5400,6300

Vertical
LHD/RHD
Standard

Baumuster

930.013
930.014
930.016
930.083
930.142
930.143
930.145
930.162
930.163
930.182
930.183
930.242
930.243
930.244
930.319
934.012
934.013
934.082
934.141
934.161
934.182
934.241

Front pipe

25626
942.490.3019
942.490.4119

V6

21619
930.490.5419

V6, 230L

21611
930.490.0419

V6

21781
942.490.3119
942.490.4219

OM 501
Excl.B M 934.241

Silencer

28129
942.490.3401
942.490.1401

Tail pipe

21323
930.490.0021

25984
942.492.0404

21336
930.490.0121

21361
942.492.0504

Mounting Parts

1.
27401
942.997.0290

2.
00958
645.492.0440
071.555.130.500
942.492.0140

3.
27442
942.490.0141

Series ACTROS

Type

Euro II/III



- 2631
- 2635
- 2640
- 2643
- 2648
- 2653
- 2657
- 3231
- 3235
- 3240
- 3243
- 3331
- 3335
- 3340
- 3343
- 3348
- 4140
- 4143
- 4148



- 3331A K
- 3340A K
- 3343A K
- 3348A K
- 4140A K
- 4143A K

Baumuster

- 950.083
- 950.306
- 952.002
- 952.003
- 952.013
- 952.072
- 952.073
- 952.083
- 952.141
- 952.142
- 952.143
- 952.161
- 952.162
- 952.163
- 952.182
- 952.183
- 952.241
- 952.243
- 952.304
- 952.305
- 952.307
- 952.314
- 952.315
- 952.317
- 952.325
- 952.336
- 953.141
- 953.143
- 953.161
- 953.162
- 953.163
- 953.304
- 953.305
- 953.314
- 953.315
- 953.317

Front pipeT

21778
948.490.0819

►CHno 409.484

25768
948.490.4219
948.490.3219
948.490.4419
409.485 ►CHno

21789
948.490.1819

BM 952.072, 073, 083, 182, 183, 325, 336

Silencer

28195
948.490.0201
948.490.0601

27407
948.490.0030
930.490.3330

ail pipe

25938
948.492.0014

Mounting Parts

1.
27401
942.997.0290

2.
00958
645.492.0440
071.555.130.500
942.492.0140

3.
27405
942.492.0340

Vertical
LHD
Standard

Series ACTROS

Type

Euro II/III



20/32/41 ton.

OM 541

- 235K W/320H P
- 265K W/360H P
- 300K W/410H P
- 315K W/428H P
- 350K W/476H P

2032A

2036A

3241-3248

4141

Baumuster

930.083

930.306

930.319

Front pipeT

25769
948.490.3319
948.490.5119

┌ V6

21701
948.490.5519
948.490.3419

┌ V6
BM 930.083

Silencer

28195
948.490.0201
948.490.0601

ail pipe

25938
948.492.0014

21612
930.490.4119

┌ V6
Excl. 930.319

21709
948.490.5019
948.490.4519

┌ V6
High mounted engine
Excl. 930.319

28100
948.490.1001
948.490.0301
948.490.0701

┌ V8

Mounting Parts

1.
27401
942.997.0290

2.
27405
942.492.0340

3.
00969
071.555.124.501
655.492.01401

4.
00958
645.492.0440
071.555.130.500
942.492.0140

5.
27407
948.490.0030
930.490.3330

Vertical
LHD/RHD
Standard

Series ACTROS

Type

Euro II/III



- 2631
- 2635
- 2640
- 2643
- 2648
- 2653
- 2657
- 3231
- 3235
- 3240
- 3243
- 3331
- 3335
- 3340
- 3343
- 3348
- 4140
- 4143
- 4148



- 3331A K
- 3340A K
- 3343A K
- 3348A K
- 4140A K
- 4143A K

Vertical
LHD
Standard

Baumuster

- 952.072
- 952.073
- 952.083
- 952.141
- 952.142
- 952.143
- 952.161
- 952.182
- 952.183
- 952.241
- 952.243
- 952.304
- 952.305
- 952.307
- 952.314
- 952.315
- 952.325
- 952.336
- 652.162
- 652.163

Front pipe

25756
948.490.2119

V 6
▶CHno 409.484

21777
948.490.0919

V 6
▶CHno 409.484

25762
948.490.3719

V 6
409.484 ▶CHno

25755
948.490.3619

V 6
409.484 ▶CHno

25769
948.490.3319
948.490.5119

V 6
409.484 ▶CHno

25764
948.490.2218

V 6
BM. 952.072, 073, 083, 182, 183,
325, 336

21783
948.490.1719

V 6
High engine position
BM 952.072, 073, 083, 182, 183,
325, 326

25761
948.490.2319

V 6
▶CHno 409.484

Silencer

27588
948.490.0801

429.082 ▶CHno
BM. 952.141, 142, 143, 161, 162,
163, 182, 183, 241, 243, 304,
305, 307, 314, 315, 317, 325, 336

27407
948.490.0030
930.490.3330

Tail pipe

25938
948.492.0014

Mounting Parts

1.
27401
942.997.0290

2.
00958
645.492.0440
071.555.130.500
942.492.0140

Series ACTROS

Type

Euro II/III

- 1831
- 1835
- 1840
- 1843
- 1848
- 2031
- 2031A
- 2035A
- 2631
- 2635
- 2640
- 2643
- 2648
- 2653
- 2657
- 3231
- 3235
- 3240
- 3243
- 3331
- 3335
- 3340
- 3343
- 3348
- 4140
- 4143
- 4148
- 1831K
- 1831A K
- 2031A K
- 2040A K
- 3331A K
- 3340A K
- 3343A K
- 3348A K
- 4140A K
- 4143A K

Baumuster

- 950.083
- 950.306
- 952.002
- 952.003
- 952.013
- 952.072
- 952.073
- 952.083
- 952.141
- 952.142
- 952.143
- 952.161
- 952.162
- 952.163
- 952.182
- 952.183
- 952.241
- 952.243
- 952.304
- 952.305
- 952.307
- 952.314
- 952.315
- 952.317
- 952.325
- 952.336
- 953.141
- 953.143
- 953.161
- 953.162
- 953.163
- 953.304
- 953.305
- 953.314
- 953.315
- 953.317

Front pipe

25719
948.490.2719

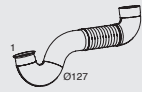
 $\varnothing 127$

V8,
High engine position
BM 952.073, 182, 335, 336

25760
948.490.1319

 $\varnothing 127$

V6
BM 952.003, 073, 141-143,
161-163, 182, 241, 243, 314,
315, 325, 336

25767
948.490.3919

 $\varnothing 127$

V8
BM 952.072, 073,
083, 182, 183, 325,
336

25758
948.490.2919

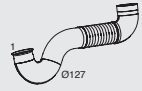
 $\varnothing 127$

V8,
Low engine position
BM 952.003, 141-143, 161-163,
314, 315

25765
948.490.2619

 $\varnothing 127$

V8,
High engine position
BM 952.073, 182, 325, 336

25766
948.490.2819

 $\varnothing 127$

V8,
Low engine position
BM 952.003,
141-143, 314, 315

25716
948.490.1619

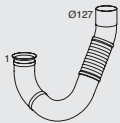
 $\varnothing 127$

V8
BM 952.003, 073, 141-143,
161-163, 182, 241, 243, 314, 315,
325, 336

25715
948.490.1419

 $\varnothing 127$

V8
BM 952.003, 073, 141-143,
161-163, 182, 241

Silencer

28100
948.490.1001
948.490.0301
948.490.0701

V 8
V 6

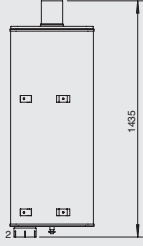
 1465

27407
948.490.0030
930.490.3330

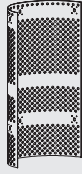

25938
948.492.0014

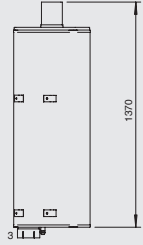

27582
Inox

 1270

27068
948.490.0030
Inox



07156
Inox



Mounting Parts

1.
27401
942.997.0290



2.
00958
645.492.0440
071.555.130.500
942.492.0140



3. Inox
00062



Vertical
LHD
Standard

SOYLU / EURO I, II, III

RENAULT

Midliner	248
Maxter	251
Midlum	253
Premium	256
Magnum	278
Kerax	286



Series MIDLINER

Type

Euro I/II



S150
S180
S210

Front pipe

31634
5010253519

Euro I, Silencerm ounted right hands ide

31630
5430046195

Euro I, Silencerm ounted left hand side

31697
5010342103

Euro II,S ilencerm ounted left hands ide

31698
5010342230

Euro II,S ilencerm ounted right hands ide

Silencer

31518
5010039826
5010163731
5010213815
Euro I

31516
5010317058
5001867404
5001867396
Euro II

Tail pipe

31336
5430246194

Silencerm ounted left hands ide

31950
5010342232

33137
5010253523

Silencerm ounted right hands ide

31320
5010327391

31335
5010253522

Silencerm ounted right hands ide

Mounting Parts

1.
00803
5003083065
5010317400
5801117294

2.
31481
5000750531
5000750497
5010570047

3.
31482
5010037316

4.
31483
5430349930
5010039685

5.
00849
5000544353
0035665142

6.
08890
5430032048
5430032047

Horizontal
LHD
Standard

Series MIDLINER

Type

Euro II



M150
M180
M210
M250

Horizontal
LHD
Standard

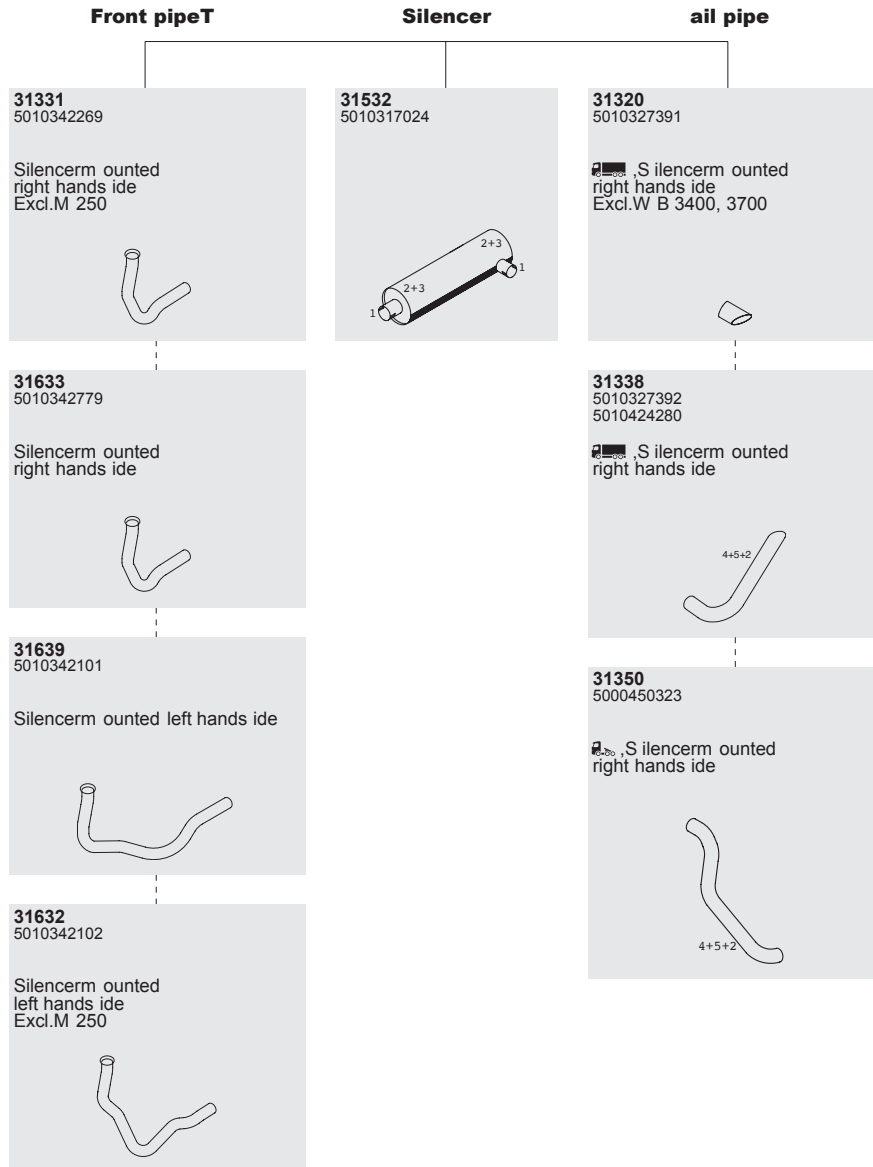

Mounting Parts

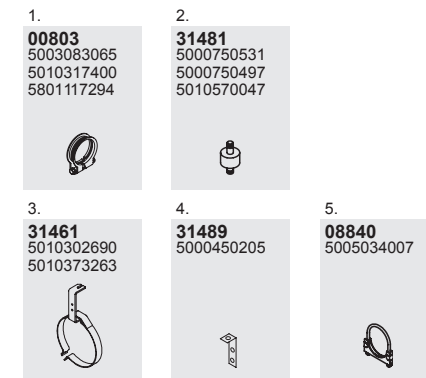

Series MIDLINER

Type

Euro II



M150
M180
M210
M250

Front pipe

Silencer

Tail pipe

31633
5010342779

Silencerm ounted
right hands ide

31639
5010342101

Silencerm ounted
left hands ide

31532
5010317024

31923
5010373938
5010342128

Excl.W B3 ,0/5,5
Steel/plastic

31926
5000454622

31914
5010267633

31631
5010342269

Silencerm ounted
right hands ide
Excl.M 250

31632
5010342102

Silencerm ounted
left hands ide
Excl.M 250

31920
5010342126
5010373936

WB 3,0
Steel/plastic

31924
5010373937

WB 5,5
Steel/plastic

Mounting Parts

1.
00803
5003083065
5010317400
5801117294

2.
31481
5000750531
5000750497
5010570047

3.
31461
5010302690
5010373263

Vertical
LHD
Standard

Series MAXTER

Type

Euro II
05/1996 →



G235
G260
G270
G300
G340TI



G300
G340TI

Front pipe

31699
5430122780



31788
5430125800

④X② ⑥X④ ⑧X④



31787
5430126521

④X② ⑥X④

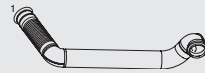

31786
5010334697

⑧X④

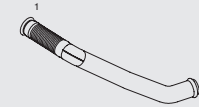

31785
5430125816

Telma



31781
5430125814

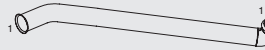

Silencer

31539
5010317120

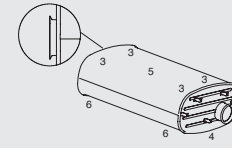

31534
5010317121

Sparka rrestor

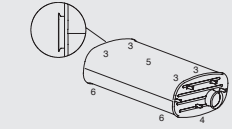

Mounting Parts

1.
31079
5001838015



2.
31076
0000704037



3.
31065
5005001185



4.
31452
5430125535



5.
31454
5430125715
5010497977



6.
31450
5430125719



Horizontal
LHD
Standard

Series MAXTER

Type

Euro II
05/1996 →



G235
G260
G270
G300
G340TI



G300
G340TI

Front pipe

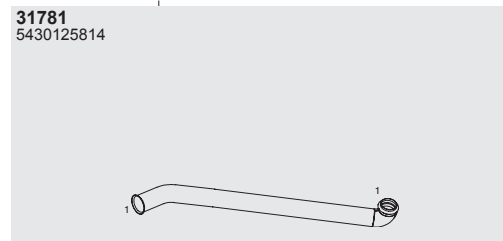
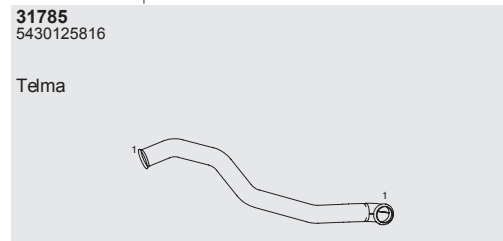
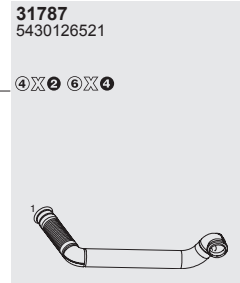
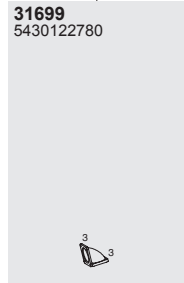

Silencer

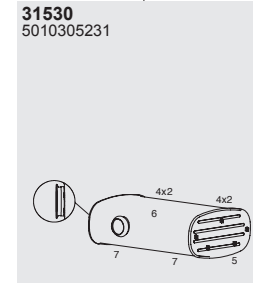

Tail pipe

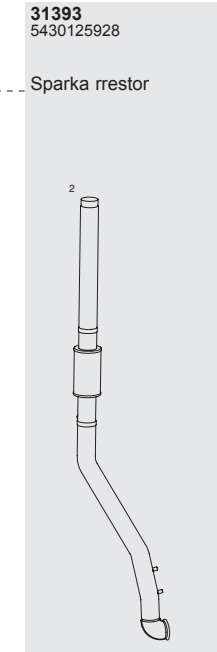
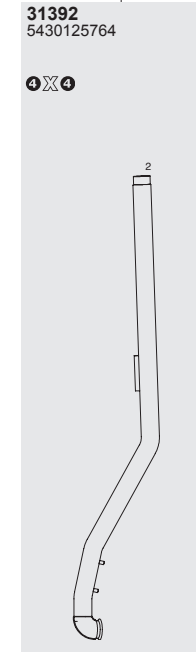

Mounting Parts

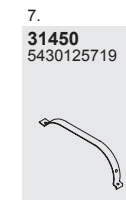
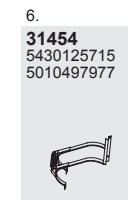
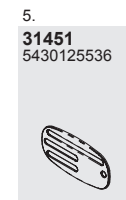
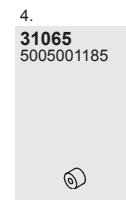
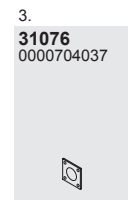
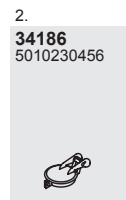
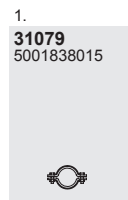

Vertical
LHD
Standard

Series MIDLUM

Type

Euro II/III



Fab.no. 42B1
Fab.no. 43E1
Fab.no. 43E2

150H P
170H P
220H P
270H P

Horizontal
LHD
Standard

Front pipe

Silencer

Tail pipe

31730
5010417199

Silencerm ounted right hands ide
Fab.no. 42B1

31114
5010317424

Fab.no. 42B1

31320
5010327391

All Fab.no.

31798
5010417198

Silencerm ounted left hands ide
Fab.no. 42B1

31937
5010496737

Fab.no. 42B1

31791
5010417169

Silencerm ounted right hands ide
Fab.no. 43E1, 43E2

31119
5010317423

Fab.no. 43E1, 43E2

31936
5010417683

Silencerm ounted right hands ide
Fab.no. 43E1, 43E2

31792
5010417500

Silencerm ounted left hands ide
Fab.no. 43E1, 43E2

31935
5010417936

Silencerm ounted left hands ide
Fab.no. 43E1, 43E2

Mounting Parts

1.
00803
5003083065
5010317400
5801117294

2.
31481
5000750531
5000750497
5010570047

3.
31425
5010355525

4.
31422
5010424257

5.
31423
5010424256

Series MIDLUM

Type

Euro II/III



Fab.no. 42B2
Fab.no. 43C1
Fab.no. 43C2
Fab.no. 43T

150H P
170H P
220H P
270H P

Front pipe

Silencer

Tail pipe

31797
5010417197

Fab.no. 42B2
Silencerm ounted
right hands ide

31791
5010417169

Fab.no. 43C1, 43C2
Silencerm ounted
right hands ide

31119
5010317423

Fab.no. 43C1, 43C2
Fab.no. 42B2

31320
5010327391

All Fab.no.

31796
5010463414

Fab.no. 42B2
Silencerm ounted
left hands ide
With elect.r etarder

31792
5010417500

Silencerm ounted
left hands ide
Fab.no. 43C1, 43C2

31936
5010417683

Silencerm ounted
right hands ide
Fab.nor. 43C1, 43C2

31795
5010417196

Fab.no. 42B2
Silencerm ounted
left hands ide
Withoute lect.r etarder

31935
5010417936

Silencerm ounted left hands ide
Fab.no. 43C1, 43C2

3. Fab.n o. 42B2 Front Silencer
Mounted right hand side With elect.
retarder

31427
5010463432

3. Fab.n o. 42B2 Front Silencer
Mounted left hand side. With elect.
retarder

31426
5010417189

Mounting Parts

1.
00803
5003083065
5010317400
5801117294

2. x2
31481
5000750531
5000750497
5010570047

3. Fab.n o. 43C1, 43C2 Silencer
Mounted left hand side

31423
5010424256

3. Fab.n o. 43C1, 43C2 Silencer
Mounted right hand side

31422
5010424257

3. Fab.n o. 42B2 Without elect. retarder

31421
5010355771
5010528795
5010327070

Horizontal
LHD
Standard

Series MIDLUM

Type

Euro II/III



Fab.no. 43C2
Fab.no. 43T

150H P
170H P
220H P
270H P

Front pipe

Silencer

Tail pipe

31791
5010417169

Fab.no. 43C2, 43T
Silencer mounted
right hands ide

OD 09 0

31113
5010317422

Fab.no. 43C2, 43T

1 2+3 2+3 02 81

31320
5010327391

AllIF ab.no.

1A2

31792
5010417500

Silencer mounted
left hands ide
Fab.no. 43C2, 43T

OD 09 0

31936
5010417683

Silencer mounted
right hands ide
Fab.no. 43C2, 43T

517

31935
5010417936

Silencer mounted
left hands ide
Fab.no. 43C2, 43T

518

Mounting Parts

1.
00803
5003083065
5010317400
5801117294

2. x2
31481
5000750531
5000750497
5010570047

3. Fab.n o. 43C2 Silencer mounted left
hand sidew ith steel tank right hand side
Fab.n o. 43T

31461
5010302690
5010373263

3. Fab.n o. 43C2. Silencer mounted right
hand sidew ith steel tank right hand side
Fab.n o. 43T

31428
5010380581

Horizontal
LHD
Standard

Series PREMIUM

Type

Euro II
PR 4X2
01.02.96 →
31.12.99

PR 4X2 FAB
22A
01.01.00 →
30.09.01

6X2 Pusher
FAB22A
01.07.97 →
31.07.99

MIDR 06.02.26
6.1l tr.
154K W/209H P
158K W/215H P
184K W/250H P

16/18/19 ton.

4X2

210.16
210.18D
250.16
250.18D
250.19

MIDR 06.23.56
11.1 ltr.

24 ton.

6X2

385.24T
400.24T

Horizontal
LHD/RHD
Standard

Front pipe

31625
5010349811
5010304375



31621
5010317210
5010230449



31622
5003083065
5010349813
5010389241

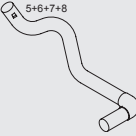

Silencer

31538
5010269366
5010230752
5010317669

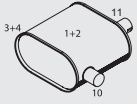

Tail pipe

31319
5010314110

→ 10.01.98
Insulation
Left hands ide



31931
5010389467

12.01.98 →
Left hands ide



31932
5010389476

05.97 →
Insulation
Right hands ide



31313
5010349319
5010282160

→ 04.97
Right hands ide



31962
5010282552
5010389478
5010497996

Left hands ide
Hydrocarbon



Mounting Parts

1.
31480
5010314097



2.
31478
5010230851



3.
31477
5010305029



4.
31476
5010314114



5.
00940
5010269114



6.
31475
5010304399



7.
31465
5000750529



8.
31471
5010282904



9.
00803
5003083065
5010317400
5801117294



10.
00784
5010317140
5010317148
5000472319



11.
00772
5010140898
0000798219
5010317399



12.
18474
5010213480



Series PREMIUM

Type

Euro II
PR 4X2, TR
4X2
6X2, 6X2/4
13.03.97 →
31.12.99
6X2 PUSHER
FAB 22A
01.07.99 →
31.07.99
FAB 22C
19.03.97 →
31.10.97
FAB 22A
01.01.00 →
30.09.01

MIDR 06.20.45
9.8l tr.
188K W/256H P
219K W/298H P
249K W/339H P
16/18/19/24/26
ton.

4X2 6X2
6X2/4
260.16
260.18
260.19
300.16, 300.16D
300.18, 300.18D
300.19
300.26D
340.18,3 40.18D
340.19,340.19D
340.24
340.26,3 40.26D

300.16T
300.18T
300.18D/T
300.19T
300.19D/T
340.18T
340.18D/T
340.19T
340.19D/T

Horizontal
LHD/RHD
Standard

Front pipe

31623
5010321860



31629
5010317056

→ 12.11.00



31624
5010349208
5010389829
5010467565

→ 12.11.00



31538
5010269366
5010230752
5010317669

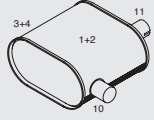

31319
5010314110

→ 10.01.98
Insulation
Left hands ide



31931
5010389467

12.01.98 →
Left hands ide



31962
5010282552
5010389478
5010497996

Left hands ide
Hydrocarbon



33765
5010497625

13.11.00 →

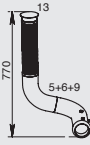

33671
5010547910

13.11.00 →



31932
5010389476

05.97 →
Insulation
Right hands ide



31313
5010349319
5010282160

→ 04.97
Right hands ide



Mounting Parts

1.
31480
5010314097



2.
31478
5010230851



3.
31477
5010305029



4.
31476
5010314114



5.
31474
5010367183



6.
31470
5010367182



7.
31468
5010349714



8.
31467
5010349738



9.
31479
5010366795
5000750630



10.
00784
5010317140
5010317148
5000472319



11.
00772
5010140898
0000798219
5010317399



12.
31076
0000704037



13.
31079
5001838015



14.
18474
5010213480



Series PREMIUM

Type

Euro III
FAB 22EE/HA
JJ/QQ/RR
01.01.01 →

④ dCi6 A
6.1l tr.
195K W/265H P
18 ton.

④ X ②
270.18

④ dCi1 1
11.1 ltr.
230K W/313H P
266K W/362H P
303K W/412H P
18/24/25/26 ton.

④ X ② ⑥ X ②
⑥ X ② / ④
320.18, 320.18D
320.24D
320.26D
370.18, 370.18D
370.24, 370.24D
370.26, 370.26D
420.18, 420.18D
420.24
420.26

④ X ② ⑥ X ②
320.18
370.18
420.18, 420.18T
420.24
420.25

Horizontal
LHD/RHD
Standard

Front pipeT

33767
5010467802

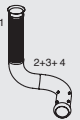

33671
5010547910



33768
5010317783

01.07.03 →

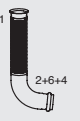

33675
5010317784

01.07.03 →

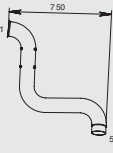

33676
5010317782

01.07.03 →

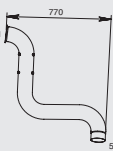

Silencer

31538
5010269366
5010230752
5010317669



ail pipe

31931
5010389467

Left hands ide



31932
5010389476

Right hands ide



31962
5010282552
5010389478
5010497996

Left hands ide
Hydrocarbon



Mounting Parts

1.
31079
5001838015



2.
31470
5010367182



3.
31474
5010367183



4.
31479
5010366795
5000750630



5.
00772
5010140898
0000798219
5010317399



6.
31441
5010317787



7.
31480
5010314097



8.
31478
5010230851



9.
00978
5010065349



10.
18474
5010213480



11.
31465
5000750529



12.
00784
5010317140
5010317148
5000472319



Series PREMIUM

Type

Euro III
 FAB 22HB
 01.01.01 →
 PR ④X② FAB
 22AB
 01.11.00 →

dCi6 A
 6.1l tr.
 195K W/265H P
 18 ton.

④X②
 270.18

dCi1 1
 11.1ltr.
 230K W/313H P
 266K W/362H P
 303K W/412H P

18 ton.
 24 ton.
 25 ton.
 26 ton.

④X②⑥X②
 ⑥X②/②

320.18,320.18D
 320.24D
 320.26D
 370.18,370.18D
 370.24,370.24D
 370.26,370.26D
 420.18,420.18D
 420.24
 420.26

④X②

320.18
 370.18
 420.18,420.18T
 420.24
 420.25

Horizontal
 LHD/RHD
 Standard

Front pipe

33766
 5010467905



33672
 5010562674

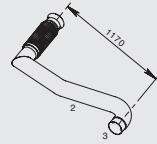

33677
 5010317781

01.07.03 →
 ForF AB 22AB

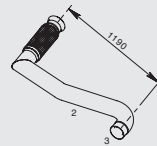

Silencer

31538
 5010269366
 5010230752
 5010317669

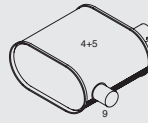

Tail pipe

31931
 5010389467

Left hands ide



31932
 5010389476

Right hahds ide
 Excl. 22HB

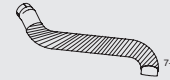

31962

5010282552
 5010389478
 5010497996
 Left hands ide
 Hydrocarbon



Mounting Parts

1.
 31079
 5001838015



2.
 08780
 5005034016
 5000951555



3.
 00772
 5010140898
 0000798219
 5010317399



4.
 31480
 5010314097



5.
 31478
 5010230851



6.
 18474
 5010213480



7.
 00978
 5010065349



8.
 31465
 5000750529



9.
 00784
 5010317140
 5010317148
 5000472319



Series PREMIUM

Type

Euro III
PR FAB
22AA
01.11.00 →

TR FAB
22CC
01.10.00 →

dCi 1
11.1 ltr.
230K W/313H P
266K W/362H P
303K W/412H P

18 ton.



320.18,320.18D
370.18,370.18D
420.18,420.18D



320.18
370.18
420.18
420.18T

dCi 6 A
6.1l tr.
195 KW/265 HP

18 ton.



270.18

Horizontal
LHD/RHD
Standard

Front pipeT

33767
5010467802

Incl. l ongd istance

33768
5010317783

Incl. l ongd istance

33671
5010547910

Incl. l ongd istance

33675
5010317784

Incl. l ongd istance

33676
5010317782

Incl. l ongd istance

Silencer

31538
5010269366
5010230752
5010317669

ail pipe

31931
5010389467

Left hands ide

31962
5010282552
5010389478
5010497996

Left hands ide
Hydrocarbon

31932
5010389476

Right hands ide

Mounting Parts

1.
31079
5001838015

2.
31470
5010367182

3.
31474
5010367183

4.
31479
5010366795
5000750630

5.
00772
5010140898
0000798219
5010317399

6.
31441
5010317787

7.
31480
5010314097

8.
31478
5010230851

X2

9.
00978
5010065349

10.
18474
5010213480

11.
31465
5000750529

12.
00784
5010317140
5010317148
5000472319

Series PREMIUM

Type

Euro II
PR 4X2, TR
6X2, 6X2/4
13.03.97 →
31.12.99

PusherF AB 22A
01.07.99 →
31.97.99

PusherC AD FAB
22C 19.03.97 →
31.10.97

FAB 22A
01.01.00 →
30.09.01

MIDR 06.23.56
11.1 ltr.
288K W/392H P
280K W/381H P
18/19/24/26t on.

4X2 6X2

385.18
385.19
385.24
385.26
400.18
400.18D
400.19
400.24
400.26

4X2 6X2

385.18T
385.19T
385.24T
400.18T
400.18D/T
400.19T
400.24T

Horizontal
LHD/RHD
Standard

Front pipe

31623
5010321860



31629
5010317056

→ 12.11.00



31624
5010349208
5010389829
5010467565

→ 12.11.00



33765
5010497625

13.11.00 →

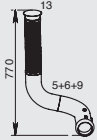

33761
5010547910

13.11.00 →



Silencer

31538
5010269366
5010230752
5010317669

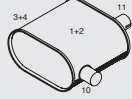

31319
5010314110

→ 10.01.98
Insulation
Left hands ide



31932
5010389476

05.97 →
Insulation
Right hands ide



Tail pipe

31931
5010389467

12.01.98 →
Left hands ide



31313
5010349319
5010282160

→ 04.97
Right hands ide



31962
5010282552
5010389478
5010497996

Left hands ide
Hydrocarbon



Mounting Parts

1.
31480
5010314097



2.
31478
5010230851

X2



3.
31477
5010305029



4.
31476
5010314114



5.
31474
5010367183



6.
31470
5010367182



7.
31468
5010349714



8.
31467
5010349738



9.
31479
5010366795
5000750630



10.
99784
5010317140
5010317148
5000472319



11.
00772
5010140898
0000798219
5010317399



12.
31076
0000704037



13.
31079
5001838015



14.
18474
5010213480



Series PREMIUM

Type

Euro II
TR ④X②
01.01.00 →
FAB 22E/H/J/Q/R
01.01.00 →
30.09.01

④ MIDR 06.20.45
9.8l tr.
219K W/298H P
249K W/339H P

16/18/19/24/26
ton.

④X② ⑥X②
⑥X②/④

300.16,300.16D
300.18,300.18D
300.19
300.26D
340.18,340.18D
340.19,340.19D
340.24
340.26,340.26D

④X②

300.16T
300.18T
300.18D/T
300.19T
300.19D/T
340.18T
340.18D/T
340.19T
340.19D/T

Horizontal
LHD/RHD
Standard

Front pipeT

31629
5010317056
→ 12.11.00

33765
5010497625
13.11.00 →

31624
5010349208
5010389829
5010467565
→ 12.11.00

33671
5010547910
13.11.00 →

Silencer

31538
5010269366
5010230752
5010317669

ail pipe

31931
5010389467
Left hands ide

31962
5010282552
5010389478
5010497996
Left hands ide
Hydrocarbon

31932
5010389476
Right hands ide

Mounting Parts

1.
31079
5001838015

2.
31470
5010367182

3.
31474
5010367183

4.
31468
5010349714

5.
31479
5010366795
5000750630

6.
00772
5010140898
0000798219
5010317399

7. TR 4x2
31480
5010314097

8. TR 4x2
31478
5010230851

9.
00978
5010065349

10.
18474
5010213480

11. Excl.T R 4x2
31477
5010305029

12. Excl.T R 4x2
31476
5010314114

13.
31465
5000750529

14.
00784
5010317140
5010317148
5000472319

Series PREMIUM

Type

Euro II
TR ④X②
01.01.00 →
FAB 22E/H/J/Q/R
01.01.00 →
30.09.01

④ MIDR 06.23.56
11.1 ltr.
280k W/381H P
288K W/392H P
18/19/24/26 ton.



385.18
385.19
385.24
385.26
400.18,400.18D
400.19
400.24
400.26



385.18T
385.19T
385.24T

400.18T,400.18D/T
400.19T
400.24T

Horizontal
LHD/RHD
Standard

Front pipe

31629
5010317056
→ 12.11.00

31624
5010349208
5010389829
5010467565
→ 12.11.00

33765
5010497625
13.11.00 →

33671
5010547910
13.11.00 →

Silencer

31538
5010269366
5010230752
5010317669

Tail pipe

31931
5010389467
Left hands ide

31932
5010389476
Right hands ide

31962
5010282552
5010389478
5010497996
Left hands ide
Hydrocarbon

Mounting Parts

1.
31079
5001838015

2.
31470
5010367182

3.
31474
5010367183

4.
31468
5010349714

5.
31479
5010366795
5000750630

6.
00772
5010140898
0000798219
5010317399

7. TR 4x2
31480
5010314097

8. TR 4x2
31478
5010230851

9.
00978
5010065349

10.
18474
5010213480

11. Excl.T R 4x2
31477
5010305029

12. Excl.T R 4x2
31476
5010314114

13.
31465
5000750529

14.
00784
5010317140
5010317148
5000472319

Series PREMIUM

Type

Euro III
TR 4X2
01.01.00 →
FAB 22E/H/J/Q/R
01.01.00 →
30.09.01

dCi1 1C
11.1 ltr.
303K W/412H P

18 ton.
24 ton.
25 ton.
26 ton.

4X2 6X2

420.18
420.18D
420.24
420.26

4X2 6X2

420.18
420.18T
420.24
420.25

Front pipeT

33767
5010467802

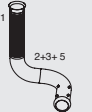

33671
5010547910



Silencer

31538
5010269366
5010230752
5010317669



ail pipe

31931
5010389467

Left hands ide



31932
5010389476

Right hands ide



31962
5010282552
5010389478
5010497996
Left hands ide
Hydrocarbon



Mounting Parts

1.
31079
5001838015



2.
31470
5010367182



3.
31474
5010367183



4.
31465
5000750529



5.
31479
5010366795
5000750630



6.
00772
5010140898
0000798219
5010317399



7. TR 4x2
31480
5010314097



8. TR 4x2
31478
5010230851



9.
00978
5010065349



10.
18474
5010213480



11. Excl.T R 4x2
31477
5010305029



12. Excl.T R 4x2
31476
5010314114



13.
00784
5010317140
5010317148
5000472319



Horizontal
LHD/RHD
Standard

Series PREMIUM

Type

Euro II
PR 4X2
01.02.96 →
31.12.99

PR 4X2 FAB
22A
01.01.00 →
30.09.01

6X2 Pusher
FAB 22A
01.07.97 →
31.07.99

MIDR 06.02.26
6.1l tr.
154K W/209H P
158k W/215H P
184K W/250H P

16/18/19 ton.



210.16
210.18D
250.16
250.18D
250.19

MIDR 06.23.56
11.1 ltr.
280K W/381H P
288K W/392H P

24 ton.



385.24T
400.24T

Vertical
LHD/RHD
Standard

Front pipe

31625
5010349811
5010304375



31478
5010317210
5010230449



00940
5003083065
5010349813
5010389241

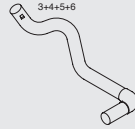

Silencer

31475
5010230770
5010317668

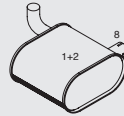

31465
5010141951
5010497374
5010317830



31471
5010141952
5010334779
5010389543
→ 03.99

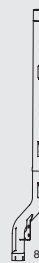

Tail pipe

00803
5010321030
5010421389
05.96 → 04.99



00772
5430122934
Heat shield



04186
5010421914
05.99 →



08783
5010421588
→ 04.99



Mounting Parts

1.
31480
5010314097



2.
31478
5010230851



3.
00940
5010269114



4.
31475
5010304399



5.
31465
5000750529



6.
31471
5010282904



7.
00803
5003083065
5010317400
5801117294



8.
00772
5010140898
0000798219
5010317399



9.
04186
5010230456



10.
08783
5000719629



Series PREMIUM

Type

Euro II
PR
 ,
13.03.97 →
31.12.99

Pusher
FAB22A
01.07.97 →
31.07.99

MIDR 06.20.45
9.8l tr.
188K W/256H P
219K W/298H P
249K W/339H P

16/18/19/24/26
ton.

260.16
260.18
260.19
300.16,300.16D
300.18,300.18D
300.19
300.26D
340.18,340.18D
340.19,340.19D
340.24
340.26,340.26D

300.16T
300.18T
300.18D/T
300.19T
300.19D/T
340.18T
340.18D/T
340.19T
340.19D/T

Vertical
LHD/RHD
Standard

Front pipe

31623
5010321860



31629
5010317056



31624
5010349208
5010389829
5010467565



31537
5010230770
5010317668



Silencer

31327
5010141951
5010497374
5010317830



31328
5010141952
5010334779
5010389543

→ 03.99



31253
5010421588

→ 04.99



Tail pipe

31326
5010321030
5010421389

→ 04.99



31381
5010421914

05.99 →

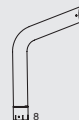

31473
5430122934



Mounting Parts

1.
31480
5010314097



2.
31478
5010230851



3.
31474
5010367183



4.
31470
5010367182



5.
31468
5010349714



6.
31467
5010349738



7.
31479
5010366795
5000750630



8.
00772
5010140898
0000798219
5010317399



9.
31079
5001838015



10.
04186
5010230456



11.
08783
5000719629



12.
31076
0000704037



Series PREMIUM

Type

Euro III
FAB 22HB
01.01.01 →
PR ④X② FAB
22AB
01.11.00 →

④ dCi6 A
6.1l tr.
195K W/265H P
18 ton.

④X②
270.18

④ dCi1 1
11.1 ltr.
230K W/313H P
266K W/362H P
303K W/412H P
18 ton.
24 ton.
25 ton.
26 ton.

④X② ⑥X②
⑥X②/④

320.18,320.18D
320.24D
320.26D
370.18,370.18D
370.24,370.24D
370.26,370.26D
420.18,420.18D
420.24
420.26

④X② ⑥X②

320.18
370.18
420.18,420.18T
420.24
420.25

Vertical
LHD/RHD
Standard

Front pipe

33766
5010467905

Incl.r efuset ruck



33672
5010562674

Incl.r efuset ruck



33677
5010317781

01.07.03 →
ForF AB 22AB



Silencer

31537
5010230770
5010317668

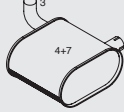

31327
5010141951
5010497374
5010317830



31264
5010317785

01.07.03 →



31253
5010421588



31254
5010530112

Forr efuse truck only



Tail pipe

31326
5010321030
5010421389



31381
5010421914

Incl.r efuse truck

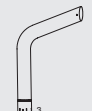

Mounting Parts

1.
31079
5001838015



2.
08780
5005034016
5000951555



3.
00772
5010140898
0000798219
5010317399



4.
31478
5010230851



5.
04186
5010230456



6.
08783
5000719629



7.
31486
5010314103



Series PREMIUM

Type

Euro III
 FAB(22EE/HA
 JJ/QQ/RR
 01.01.01 →
 PR ④X② FAB
 22AA
 01.11.00 →
 TR ④X② FAB
 22CC
 01.10.00 →

④ dCi6 A
 6.1l tr.
 195K W/265H P
 18 ton.

④X②
 270.18

④ dCi1 1
 11.1 ltr.
 230K W/313 HP
 266K W/362 HP
 303 KW/412 HP
 18/24/25/26 ton.

④X② ⑥X②
 ⑥X②/④

320.18,320.18D
 320.24D
 320.26D
 370.18,370.18D
 370.24,370.24D
 370.26,370.26D
 420.18,420.18D
 420.24
 420.26

④X② ⑥X②

320.18
 370.18
 420.18,420.18T
 420.24
 420.25

Vertical
 LHD/RHD
 Standard

Front pipe

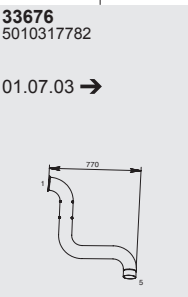
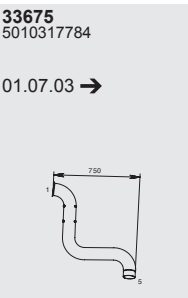
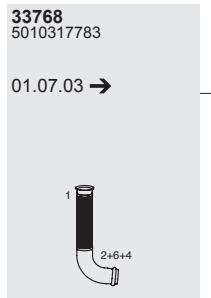
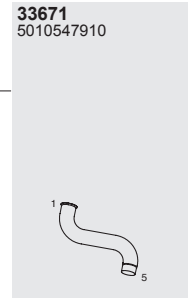
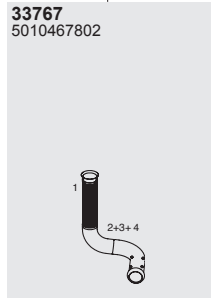

Silencer

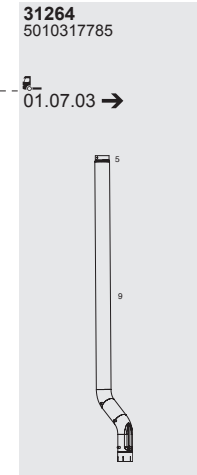
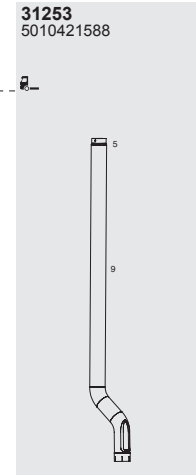
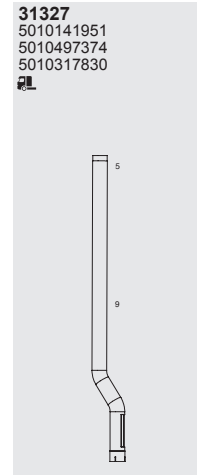
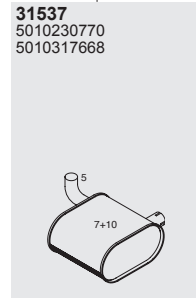

Tail pipe

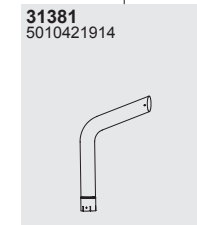
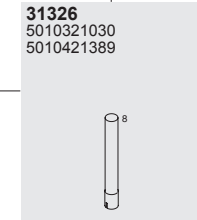

Mounting Parts

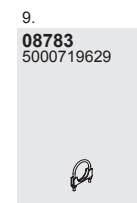
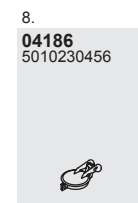
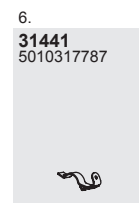
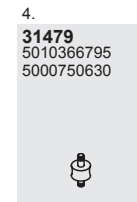
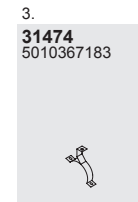
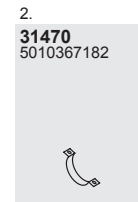
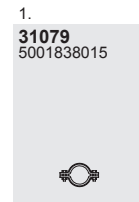

Series PREMIUM

Type

Euro II
TR 4X2
01.01.00 →
FAB 22E/H/J/Q/R
01.01.00 →
30.09.01

MIDR 06.20.45
9.8l tr.
219K W/298H P
249K W/339H P

16/18/19/24/26
ton.

4X2 6X2
6X2/4

300.16,300.16D
300.18,300.18D
300.19
300.26D
340.18,340.18D
340.19,340.19D
340.24
340.26,340.26D

4X2

300.16T
300.18T
300.18D/T
300.19T
300.19D/T
340.18T
340.18D/T
340.19T
340.19D/T

Front pipe

31629
5010317056
→ 12.11.00

31624
5010349208
5010389829
5010467565
→ 12.11.00

33765
5010497625
13.11.00 →

33671
5010547910
13.11.00 →

Silencer

31537
5010230770
5010317668

31253
5010421588
→ 12.11.00

Tail pipe

31326
5010321030
5010421389
22E/H/J/Q/R

31381
5010421914

Mounting Parts

1.
31079
5001838015

2.
31470
5010367182

3.
31474
5010367183

4.
31479
5010366795
5000750630

5.
00772
5010140898
0000798219
5010317399

6.
31478
5010230851

7.
04186
5010230456

8.
08783
5000719629

9.
31486
5010314103

Vertical
LHD/RHD
Standard

Series PREMIUM

Type

Euro II
TR ④X②
01.01.00 →
FAB 22E/H/J/Q/R
01.01.00 →
30.09.01

MIDR 06.23.56
11.1 ltr.
280K W/381H P
288K W/392H P
18/19/24/26 ton.

④X② ⑥X②
⑥X②/④

385.18
385.19
385.24
385.26
400.18
400.18D
400.19
400.24
400.26

④X② ⑥X②
⑥X②/④

385.18T
385.19T
385.24T
400.18T
400.18D/T
400.19T
400.24T

Front pipe

31626
5010317056
→ 12.11.00



31624
5010349208
5010389829
5010467565
→ 12.11.00



33765
5010497625
13.11.00 →

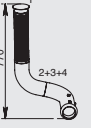

33671
5010547910
13.11.00 →



Silencer

31537
5010230770
5010317668



31253
5010421588



Tail pipe

31326
5010321030
5010421389
22E/H/J/Q/R



31381
5010421914



Mounting Parts

1.
31079
5001838015



2.
31470
5010367182



3.
31474
5010367183



4.
31479
5010366795
5000750630



5.
00772
5010140898
0000798219
5010317399



6.
31478
5010230851



7.
04186
5010230456



8.
08783
5000719629



9. 22H/Q
31486
5010314103



Vertical
LHD/RHD
Standard

Series PREMIUM

Type

Euro III
TR 4X2
01.01.00 →
FAB 22E/H/J/Q/R
01.01.00 →
30.09.01

dCi1 1C
11.1 ltr.
303K W/412H P

18 ton.
24 ton.
25 ton.
26 ton.

4X2 6X2

420.18
420.18D
420.24
420.26

4X2 6X2

420.18
420.18T
420.24
420.25

Front pipe

33767
5010467802

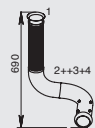

33671
5010547910



Silencer

31537
5010230770
5010317668

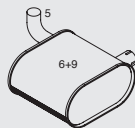

Tail pipe

31253
5010421588

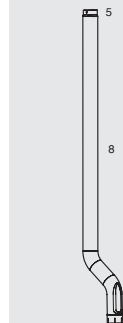

31326
5010321030
5010421389
22E/H/J/Q/R



31381
5010421914

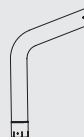

Mounting Parts

1.
31079
5001838015



2.
31470
5010367182



3.
31474
5010367183



4.
31479
5010366795
5000750630



5.
00772
5010140898
0000798219
5010317399



6.
31478
5010230851



7.
04186
5010230456



8.
08783
5000719629



9. 22H/Q
31486
5010314103



Vertical
LHD/RHD
Standard

Series PREMIUM

Type

Euro III
TR 4X2
01.01.00 →
FAB 22E/H/J/Q/R
01.01.00 →
30.09.01

dCi1 1C
11.1 ltr.
303K W/412H P

18 ton.
24 ton.
25 ton.
26 ton.

4X2 6X2

420.18
420.18D
420.24
420.26

4X2 6X2

420.18
420.18T
420.24
420.25

Front pipe

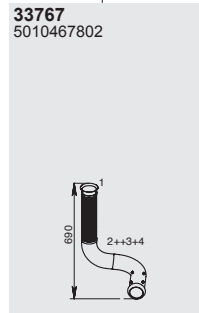

Silencer

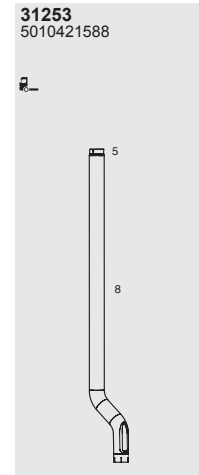
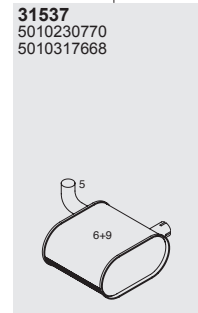

Tail pipe

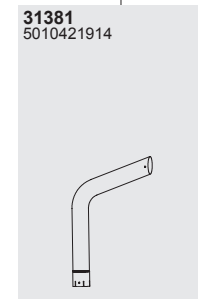
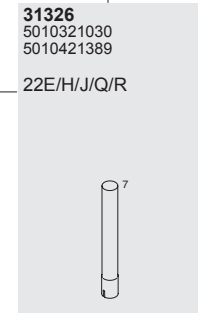

Mounting Parts

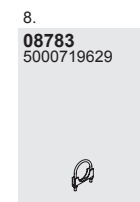
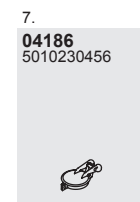
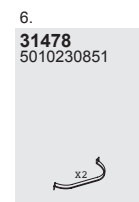
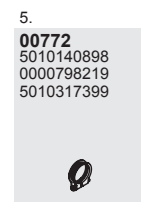
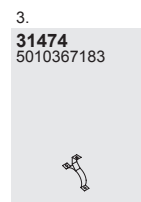
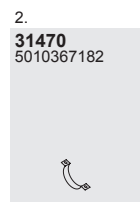
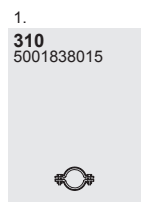

Vertical
LHD/RHD
Standard

Series PREMIUM

Type

Euro II
PR 4X2 FAB
22A
01.01.00 →
30.09.01

MIDR 06.20.45
9.8ltr.
188K W/256H P
219K W/298H P
249K W/339H P

16/18/19 ton.



260.16
260.18
260.19
300.16,300.16D
300.18,300.18D
300.19
340.18,340.18D
340.19,340.19D



300.16T
300.18T
300.18D/T
300.19T
300.19D/T
340.18T
340.18D/T
340.19T
340.19D/T

Vertical
LHD/RHD
Standard

Front pipe

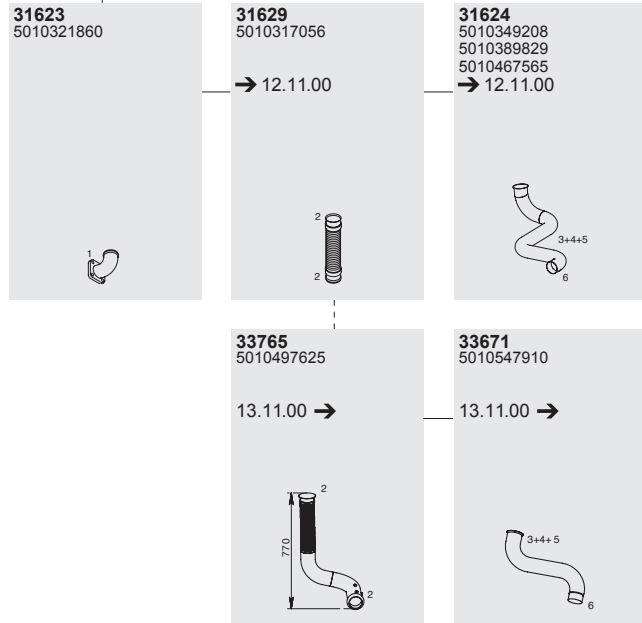

Silencer

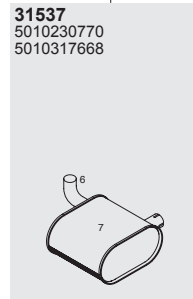

Tail pipe

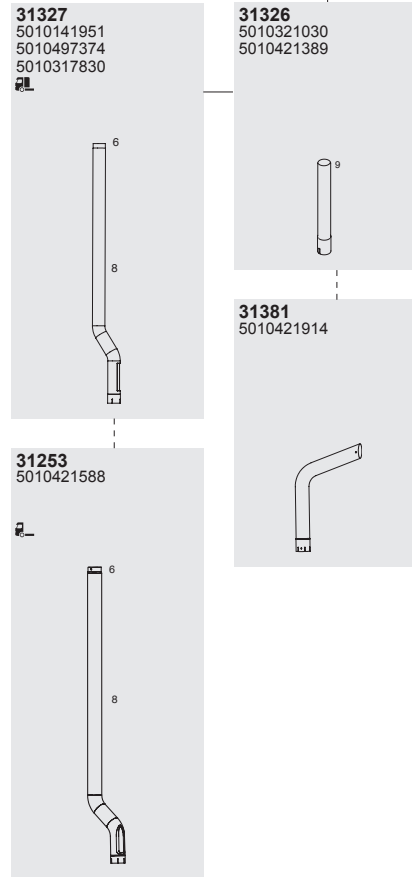

Mounting Parts



Series PREMIUM

Type

Euro II
PR 4X2 FAB
22A
01.01.00 →
30.09.01

MIDR 06.23.56
11.1 ltr.
280K W/381H P
288K W/392H P

18 ton.
19 ton.



385.18
385.19
400.18
400.18D
400.19



385.18T
385.19T
400.18T
400.18D/T
400.19T

Front pipe

31623
5010321860

31629
5010317056

→ 12.11.00

31624
5010349208
5010389829
5010467565

→ 12.11.00

31537
5010230770
5010317668

31327
5010141951
5010497374
5010317830

1326
5010321030
5010421389

33765
5010497625

13.11.00 →

33671
5010547910

13.11.00 →

31253
5010421588

31381
5010421914

Mounting Parts

1.
31076
0000704037

2.
31079
5001838015

3.
31470
5010367182

4.
31474
5010367183

5.
31479
5010366795
5000750630

6.
00772
5010140898
0000798219
5010317399

7.
31478
5010230851

8.
08783
5000719629

9.
04186
5010230456

Vertical
LHD/RHD
Standard

Series PREMIUM

Type

Euro II
PR 4X2
6X2 6X2/4
13.03.97 →
31.12.99

6X2 Pusher
FAB22A
01.07.97 →
31.07.99

MIDR 06.23.56
11.1 ltr.
280K W/381H P
288K W/392H P
18/19/24/26 ton.

4X2 6X2

385.18
385.19
385.24
385.26
400.18
400.19
400.24
400.26

4X2 6X2

385.18T
385.19T
385.24T
400.18T
400.19T
400.24T

Vertical
LHD/RHD
Standard

Front pipe

31623
5010321860



31629
5010317056



31624
5010349208
5010389829
5010467565



Silencer

31537
5010230770
5010317668

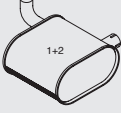

31327
5010141951
5010497374
5010317830
RL RL

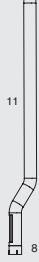

31328
5010141952
5010334779
5010389543
→ 03.99

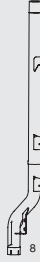

Tail pipe

31326
5010321030
5010421389
→ 04.99



31473
5430122934



31381
5010421914
05.99 →



31253
5010421588
→ 04.99



Mounting Parts

1.
31480
5010314097



2.
31478
5010230851



3.
31474
5010367183



4.
31470
5010367182



5.
31468
5010349714



6.
31467
5010349738



7.
31479
5010366795
5000750630



8.
00772
5010140898
0000798219
5010317399



9.
31079
5001838015



10.
04186
5010230456



11.
08783
5000719629



12.
31076
0000704037



Series PREMIUM

Type

Euro III
FAB2 7
JC/TC/RC/SC
10.2005 →

DXi 11
10.8l tr.
272K W/370H P
302K W/410H P
331K W/450H P

18 ton.
24 ton.
25 ton.
26 ton.



370.18D
370.26
410.18D
410.24
410.25
410.26
450.18D
450.24
450.25
450.26



410.18
410.18D
410.25
450.18
450.25

Horizontal
LHD/RHD
Left

Front pipe

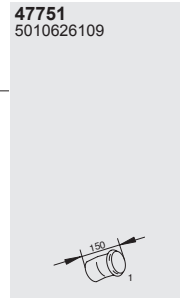
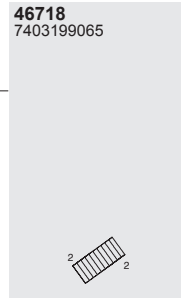
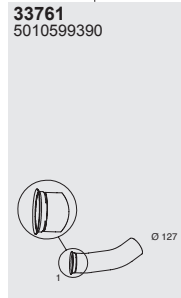

Silencer

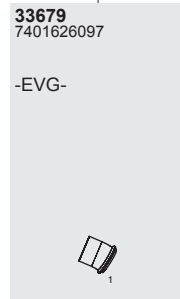
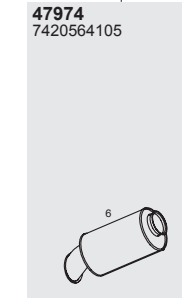
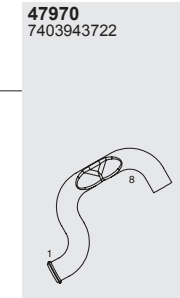
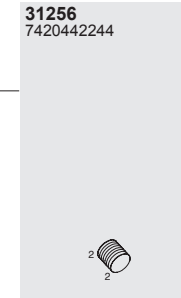
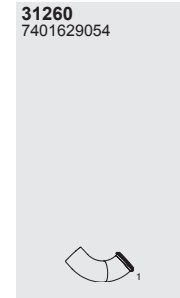
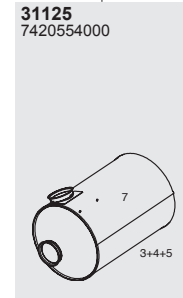

Mounting Parts

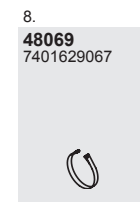
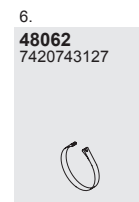
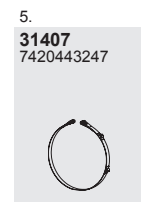
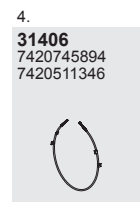
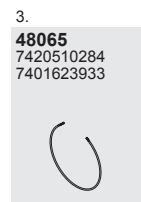
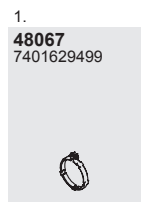

Series PREMIUM

Type

Euro III
FAB2 7
JC/TC/RC/SC
10.2005 →

DXi 11
10.8l tr.
272K W/370H P
302K W/410H P
331K W/450H P

18 ton.
24 ton.
25 ton.
26 ton.



370.18D
370.26
410.18D
410.24
410.25
410.26
450.18D
450.24
450.25
450.26



370.18D
410.18
410.18D
410.25
450.18
450.25

Front pipe

33761
5010599390

46718
7403199065

47751
5010626109

33679
7401626097

-EVG-

Silencer

31125
7420554000

31257
7408159458

With/without idemp rotation: tank 790L
With/without power take-off: tank 330L

31255
7420443348
5010617028
5010617029

With/without idemp rotation:
tank 255L,315L,330L,365L,415L,445L,
450L,505L,610L,650L,690L
With/without power take-off:
tank 255L,315L,415L,630L

Tail pipe

48182
7420564258

With/without idemp rotation: tank 790L,
With power take-off:
tank 255L,315L,330L,415L,630L

47966
7420534879

With/without idemp rotation:
tank 255L,315L,330L,365L,415L,
445L,450L,505L,610L,650L,690L
With/without power take-off:
255L,315L,330L,415L,630L

Mounting Parts

1.
48067
7401629499

2.
00564
7420455908

3.
48065
7420510284
7401623933

4.
31406
7420745894
7420511346

5.
31407
7420443247

6.
31446
7420506180

7.
31408
5010606811

8.
48062
7420743127

Horizontal
LHD/RHD
Right

Series **MAGNUM**

Type

Euro II



AE390
AE430
AE470

Front pipe

31627
5010370028
5010418818
④X② ⑥X②

31626
5010317223
5001864374

31727
5010370029
⑥X④

Silencer

31522
5010317118
→ 05.98

31596
5010317256
5010317418
5010317672
06.98 →

Tail pipe

31311
5010320504
5010370051

Mounting Parts

1.
00719
5010213799

2.
31072
5010273757

3.
31464
5001822078

4.
00769
5010211436

5.
31481
5000750531
5000750497
5010570047

Horizontal
LHD
Standard

Series **MAGNUM**

Type

Euro II

 AE420 TI

Front pipe

31610
5010273067



31614
5010269186



31667
5010211671
5010273064

84 db

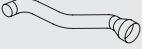

31028
5010273217

80 db



Silencer

31513
5010269600
5010213020
5001867399

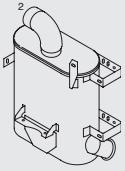

Mounting Parts

1.
31076
0000704037



2.
00164
5010213269



3.
00784
5010317140
5010317148
5000472319



4.
31464
5001822078



Horizontal
LHD
Standard

Series **MAGNUM**

Type

Euro II

 AE560

Front pipe

Silencer

31666
5010137902
5010211753



31770
5010213268



31513
5010269600
5010213020
5001867399

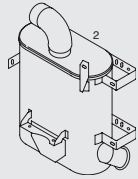

Mounting Parts

1.
00719
5010213799



2.
31464
5001822078



3.
31075
5010230700



Horizontal
LHD
Standard

Series **MAGNUM**

Type

Euro II



AE390
AE420 TI
AE430
AE470
AE560

Vertical
LHD
Standard

Front pipe

31627
5010370028
5010418818

AE 390, AE430
AE470



31626
5010317223
5001864374



31610
5010273067



31614
5010269186



31666
5010137902
5010211753



31770
5010213268



Silencer

31524
5010317127

AE390, AE430
AE470

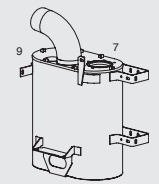

31529
5010140426

AE420 TI

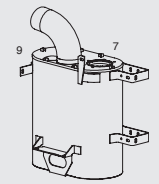

31520
5010269788

AE560

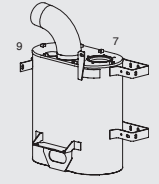

Tail pipe

31312
5010137858



31963
5010370120

CAM-FW ▶CHno
AE390, A E430
AE470

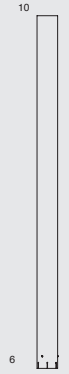

31969
5010370118

CAM-FW ▶CHno
AE390, A E430
AE470



Mounting Parts



1. 00719 5010213799	2. 00164 5010213269
3. 31076 0000704037	4. 31075 5010230700
5. 00784 5010317140 5010317148 5000472319	6. 00769 5010211436
7. 31073 5010051671	8. 31072 5010273757
9. 31460 5001822079	10. 04327

Series MAGNUM

Type

Euro III
08/2002 →

18 ton
④X②

 E.TECH 400.18
E.TECH 440.18
E.TECH 480.18
 E.TECH 400.18T
E.TECH 440.18T
E.TECH 480.18T

 **MACK**
E.TECH A46
12,0 ltr.
6 cyl.
295 KW/401 HP

 **MACK**
E.TECH B46
12,0l tr.
6 cyl.
324K W/441H P

 **MACK**
E.TECH C46
12,0l tr.
6 cyl.
347 KW/472 HP
353 KW/480 HP

11E/11F

Front pipe

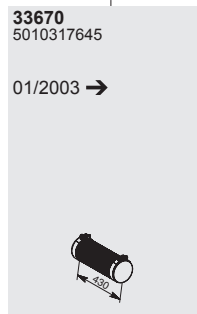
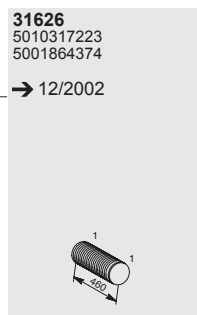
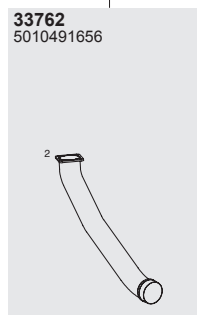

Silencer

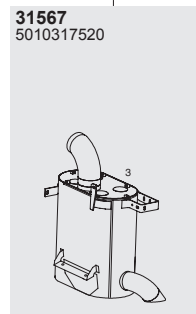
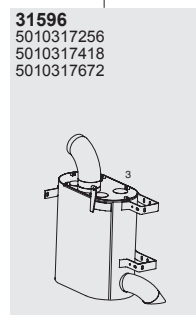

Mounting Parts

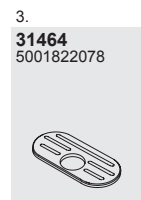
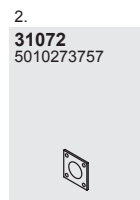
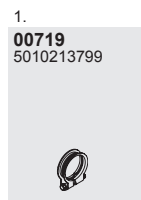

Horizontal
LHD/RHD
Standard

Series **MAGNUM**

Type

Euro III
08/2002 →

④X②
⑥X② ⑥X③

18 ton.
24 ton.
26 ton.

 E.TECH 400.18
E.TECH 400.24
E.TECH 400.26
E.TECH 440.18
E.TECH 440.24
E.TECH 440.26
E.TECH 480.18
E.TECH 480.24
E.TECH 480.26

 E.TECH 400.18T
E.TECH 440.18T
E.TECH 440.26T
E.TECH 480.18T
E.TECH 480.26T

 MACK
E.TECH A46
12,0l tr.
6 cyl.
295K W/401H P

 MACK
E.TECH B46
12,0l tr.
6 cyl.
324 KW/441 HP

 MACK
E.TECH C46
12,0l tr.
6 cyl.
347 KW/472 HP
353 KW/480 HP

11E/11H

Vertical
LHD/RHD
Standard

Front pipeS

33762
5010491656

11H

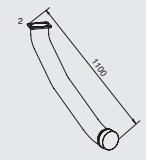

33763
5010491693

11E

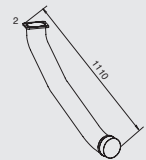

31626
5010317223
5001864374

→ 12/2002



33670
5010317645

01/2003 →



ilencer

31524
5010317127

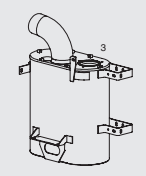

31969
5010370118

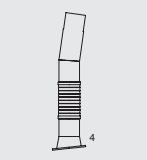

31259
5010418888

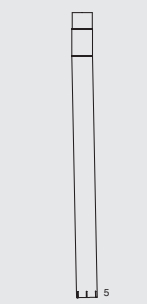

Tail pipe

31934
5010418881

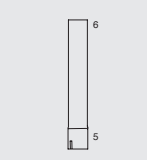

Mounting Parts

1.
00719
5010213799



2.
31072
5010273757



3.
31460
5001822079



4.
31073
5010051671



5.
00769
5010211436



6.
04169
5010317238



Series **MAGNUM**

Type

Euro III
10/04 → 04/06
DXi 12
12,1l tr.
6 cyl.
324K W/441H P
353K W/480H P

18 ton.
24 ton.
26 ton.



440.18
440.24
440.26
480.18
480.24
480.26



440.18 T
4402 6T
480.18 T
480.26 T

Horizontal
LHD/RHD
Left

Front pipe

47756
7401629939



1+2
Ø1 27

46718
7403199065



3
3

33679
7401626097



2

Silencer

31125
7420554000

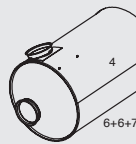

4
6+6+7

31260
7401629054

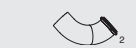

2

31256
7420442244



3
3

Tail pipe

47970
7403943722

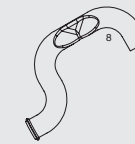

8

47966
7420534879

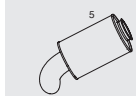

5
2

Mounting Parts

1.
48068
7401638168



2.
48067
7401629499



3.
00564
7420455908



4.
31446
7420506180



5.
48061
7401628246
7401629345



6.
48065
7420510284
7401623933



7.
31407
7420443247



8.
48069
7401629067



Series **MAGNUM**

Type

Euro III
10/04 → 04/06
DXi 12
12,1l tr.
6 cyl.
324K W/441H P
353K W/480H P

18 ton.
24 ton.
26 ton.



440.18
440.24
440.26
480.18
480.24
480.26



440.18 T
4402 6T
480.18 T
480.26 T

Front pipes

47756
7401629939

46718
7403199065

33679
7401626097

ilencer

31125
7420554000

31255
7420443348
5010617028
5010617029
With/without idep rotection:
With tank 415/445/505/610L,
With tank aluminium 650L

Withouts idep rotection, with tank 510L

31257
7408159458

With tank aluminium 715L.
with/without idep rotection

Tail pipe

48182
7420564258

With/without idep rotection:
With tank 415/610L
With tank aluminium 650/715L

Withouts idep rotection:
with tank 445/505/510L

47966
7420534879

With tank 445/505L.
with side protection

Mounting Parts

1.
48068
7401638168

2.
48067
7401629499

3.
00564
7420455908

4.
31446
7420506180

5.
31408
5010606811

6.
48065
7420510284
7401623933

7.
31407
7420443247

8.
48062
7420743127

Horizontal
LHD/RHD
Right

Series **KERAX**

Type

Euro II
→ 1999

33G, 33I, 33J
33K, 33L, 33Q
33H, 3 3P, 33M
33R, 33S, 33A
33B, 33C, 33D

18/26/32 ton.

4X2 4X4 6X6
6X4 8X4

6X4 8X4

6X4

MIDR 06.20.45
9.8l tr.
188K W/256 HP
219K W/298 HP
249K W/339 HP

4X2 4X4 6X6
6X4 8X4

6X4 8X4

4X2 4X4 6X6

MIDR 06.23.56
11,1 ltr.
280K W/381 HP

Horizontal
LHD/RHD
Standard

Front pipe

31699
5430122780



31784
5430127816
5430127482



31778
5010467712
33G/I/J/K/L/Q/H/P

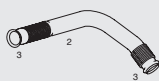

31780
5430127814
5430059910
33M/R/S

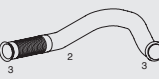

31777
5430128007
5010317650
8X4
33A/B/C/D

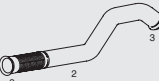

Mounting Parts

1.
31076
0000704037



2.
98780
5005034016
5000951555



3.
31079
5001838015



4.
31454
5430125715
5010497977



5.
31450
5430125719



6.
31452
5430125535



7.
31065
5005001185



Silencer

31590
5010317200
LHD

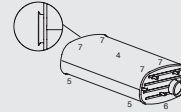

31548
5010317183
LHD

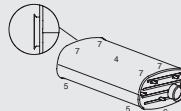

31592
5010317194
5010317268
RHD

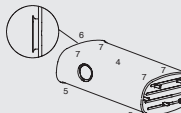

Tail pipe

31930
5430128238
RHD



31768
5430128712
8X4
33A/B/C/D



31776
5430128713
8X4
33A/B/C/D

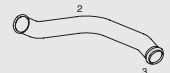

Series KERAX

Type

Euro III

2000 →



- ④X②
- ④X④
- ⑥X②
- ⑥X④
- ⑥X⑥
- ⑧X④

Front pipe

31699
5430122780



31784
5430127816
5430127482



31767
5010497548
5010317647

④X② ⑥X② ⑥X④

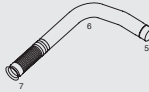

31766
5010497522
5010317649

④X④ ⑥X⑥



31777
5430128007
5010317650

⑧X④

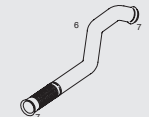

31765
5010497553



31761
5010497552



Silencer

31593
5010317508
5010317534

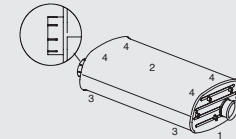

31594
5010317468

CAG

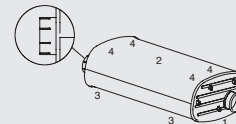

Mounting Parts

1.

31452
5430125535



2.

31454
5430125715
5010497977



3.

31450
5430125719



4.

31065
5005001185



5.

00772
5010140898
0000798219
5010317399



6.

08780
5005034016
5000951555



7.

31079
5001838015



8.

31076
0000704037



Horizontal
LHD
Standard

Series **KERAX**

Type

Euro III

FAB 33A → S
 2000 → 2002
 33G, 33J
 33K, 33Q
 33H, 33L
 33I
FAB 33A//I.R
 2003 → 2005
 33G, 33K, 33Q
 33H, 33L

18/26/32 ton.



MIDR 06.20.45
 9.8l tr.
 188K W/256H P
 219K W/298H P
 249K W/339H P



MIDR 06.23.56
 11.1 ltr.
 280K W/381H P
 288K W/392H P

Page 1/2
 Next page:
 (syst.164001013)

Vertical
 LHD/RHD
 Standard

Front pipe

31699
 5430122780



31784
 5430127816
 5430127482



31778
 5010467712

→ 16.10.00



31592
 5010317194
 5010317268

→ 20.11.00

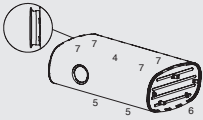

31767
 5010497548
 5010317647

16.10.00 →



31599
 5010317452

20.11.00 →

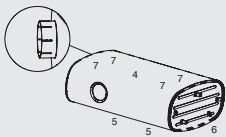

Mounting Parts

1.
31076
 0000704037



2.
08780
 5005034016
 5000951555



3.
31079
 5001838015



4.
31454
 5430125715
 5010497977



5.
31450
 5430125719



6.
31451
 5430125536



7.
31065
 5005001185



8.
00772
 5010140898
 0000798219
 5010317399



Series **KERAX**

Type

Euro III

FAB 33A → S
 2000 → 2002
 33G, 33J
 33K, 33Q
 33H, 33L
 33I
FAB 33A//I.R
 2003 → 2005
 33G, 33K, 33Q
 33H, 33L

18/26/32 ton.

4X2 4X4 6X4 6X6
6X4 6X6

6X4 6X6

6X4

MIDR 06.20.45
 9.8l tr.
 188K W/256H P
 219K W/298H P
 249K W/339H P

4X2 4X4 6X4 6X6
6X4 6X6

6X4 6X6

4X2 4X4 6X4 6X6

MIDR 06.23.56
 11.1 ltr.
 280K W/381H P
 288K W/392H P

Page 2/2
 Previous page:
 (syst.164001012)

Vertical
 LHD/RHD
 Standard

Silencer

31592
 5010317194
 5010317268
 → 20.11.00

31599
 5010317452
 20.11.00 →

31349
 5430128327
33K/L

31343
 5430128496
33K/L

31342
 5430128237

31341
 5430128236

33661
 5010497587
33H 2003 →

33669
 5010497588
33H 2003 →

Tail pipe

31344
 5430127014

64689
 5010421268

Mounting Parts

1.
31065
 5005001185

2.
00772
 5010140898
 0000798219
 5010317399

3.
31079
 5001838015

4.
31454
 5430125715
 5010497977

5.
31450
 5430125719

6.
31451
 5430125536

7.
04186
 5010230456

Series **KERAX**

Type

Euro III

FAB 33A → S
2000 → 2002
33M
33N
33R
33S

FAB 33A/.I/.R
2003 → 2005
33M
33N
33R

16/26/32 ton.

 **4X2 4X4 6X6**
6X4 8X4

 **6X4 8X4**

 **6X4**

 **MIDR 06.20.45**
9.8l tr.
188K W/256H P
219K W/298H P
249K W/339H P

 **4X2 4X4 6X6**
6X4 8X4

 **6X4 8X4**

 **4X2 4X4 6X4**

 **MIDR 06.23.56**
11.1 ltr.
280K W/381H P
288K W/392H P

Vertical
LHD/RHD
Standard

Front pipe

31699
5430122780



31784
5430127816
5430127482



31766
5010497522
5010317649

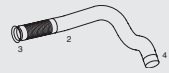

33684
5010317648

33M/N
33R 2003 →



Silencer

31599
5010317452

20.11.00 →

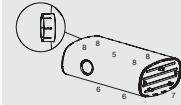

31342
5430128237



31341
5430128236

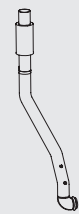

Tail pipe

31344
5430127014



31340
5010421268



Mounting Parts

1.
31076
0000704037



2.
08780
5005034016
5000951555



3.
31079
5001838015



4.
00772
5010140898
0000798219
5010317399



5.
31454
5430125715
5010497977



6.
31450
5430125719



7.
31451
5430125536



8.
31065
5005001185



9.
04186
5010230456



Series **KERAX**

Type

Euro III

FAB 33A → S
2000 → 2002
FAB 33A.I.I.R
2003 → 2005

18/26/32 ton.

33P

 4X2 4X4 6X6
6X4 8X4

 6X4 8X4

 6X4

 MIDR 06.20.45
9.8l tr.
188K W/256H P
219K W/298H P
249K W/339H P

 4X2 4X4 6X6
6X4 8X4

 6X4 8X4

 4X2 4X4 6X4

 MIDR 06.23.56
11.1 ltr.
280K W/381H P
288K W/392H P

Page 1/2
Next page:
(syst.164001016)

Vertical
LHD/RHD
Standard

Front pipe

Silencer

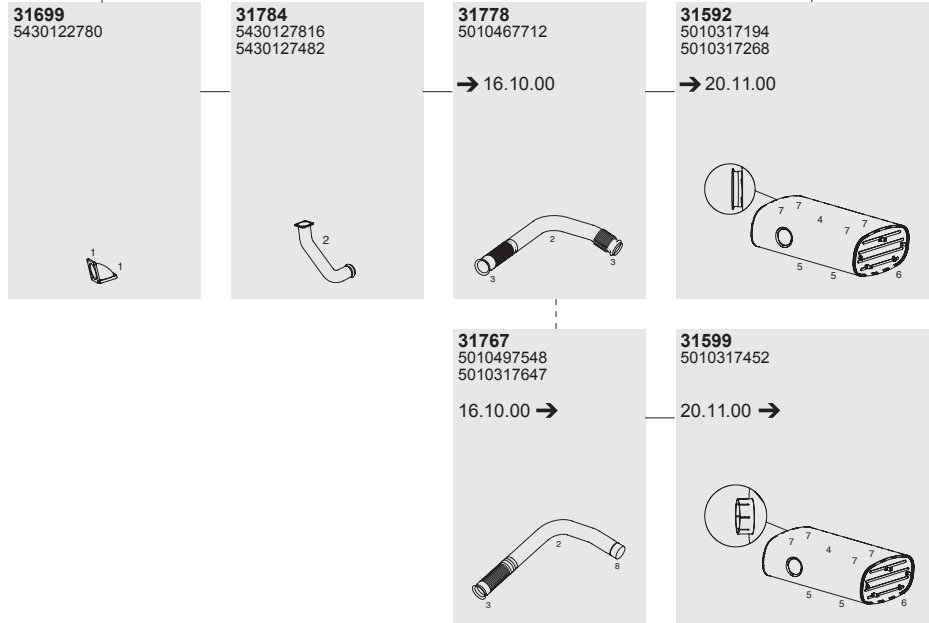

Mounting Parts

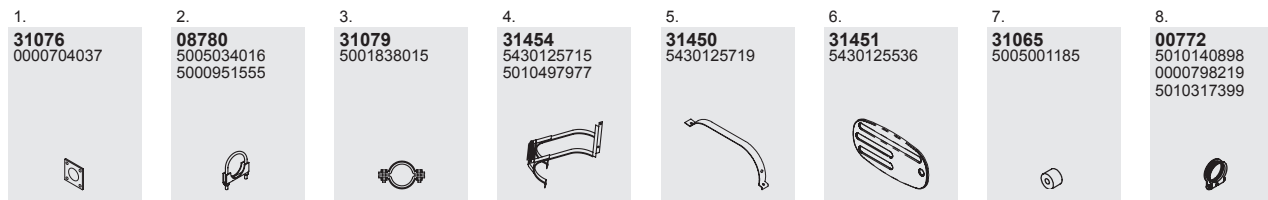

Series **KERAX**

Type

Euro III

FAB 33A → S
2000 → 2002
FAB 33A/././R
2003 → 2005

18/26/32 ton.

33P

 **4X2 4X4 6X6**
6X4 8X4

 **6X4 8X4**

 **6X4**

 **MIDR 06.20.45**
9.8l tr.
188K W/256H P
219K W/298H P
249K W/339H P

 **4X2 4X4 6X6**
6X4 8X4

 **6X4 8X4**

 **4X2 4X4 6X4**

 **MIDR 06.23.56**
11.1 ltr.
280K W/381H P
288K W/392H P

Page 2/2
Previous page:
(syst.164001015)

Vertical
LHD/RHD
Standard

Silencer

31592
5010317194
5010317268
→ 31.08.00

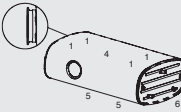

31349
5430128327
→ 31.08.00



31342
5430128237
→ 31.08.00



31343
5430128496
→ 31.08.00



31341
5430128236
→ 31.08.00

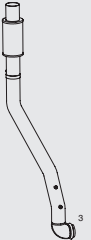

31599
5010317452
04.09.00 →

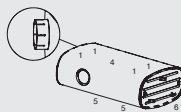

33669
5010497588
04.09.00 →



33661
5010497587
04.09.00 →



Tail pipe

31344
5430127014
→ 2002



31340
5010421268



Mounting Parts

1.
31065
5005001185



2.
00772
5010140898
0000798219
5010317399



3.
31079
5001838015



4.
31454
5430125715
5010497977



5.
31450
5430125719



6.
31451
5430125536



7.
04186
5010230456



Series **KERAX**

Type

Euro III

FAB 33A → S
2000 → 2002
33G, 33I, 33J
33K, 33L, 33Q
33H, 33P

FAB 33A/.R
2003 →
33G, 33H, 33K
33L, 33P, 33Q

18/26/32 ton.



MIDR 06.20.45
9.8l tr.
188K W/256H P
219K W/298H P
249K W/339H P



MIDR 06.23.56
11,1 ltr.
280K W/381H P
288K W/392H P

Horizontal
LHD/RHD
Standard

Front pipe

31699
5430122780



31784
5430127816
5430127482



31778
5010467712
→ 16.10.00

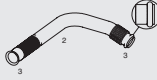

31767
5010497548
5010317647
33G/Q/H/P 16.10.00 →
33K/L 16.10.00 → 03.10.05



33665
5430066143
NOTE DTI 2870-318
2003 →

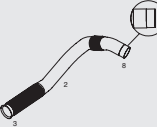

Silencer

31590
5010317200
→ 16.10.00
LHD

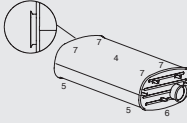

31548
5010317183
→ 16.10.00
LHD

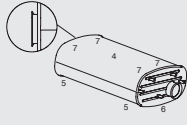

31592
5010317194
5010317268
→ 16.10.00
RHD

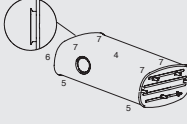

31593
5010317508
5010317534
33G/H/K/L/Q 16.10.00 →
33P 04.09.00 →
Incl.NOTED TI 2870-318

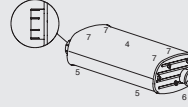

31594
5010317468
33G/H/K/L/Q 16.10.00 →
33P 04.09.00 →



31587
5010317581
33G/H/K/L/Q 16.10.00 →
33P 04.09.00 →

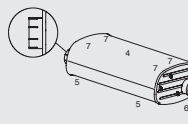

Tail pipe

31930
5430128238
RHD



Mounting Parts

1.
31076
0000704037



2.
08780
5005034016
5000951555



2a.
08783
5000719629



3.
31079
5001838015



4.
31454
5430125715
5010497977



5.
31450
5430125719



6.
31452
5430125535



7.
31065
5005001185



8.
00772
5010140898
0000798219
5010317399



Series KERAX

Type

Euro III
 FAB 33AA../..SS
 2000 →
 DAY CAB

 33GG
 33II
 33KK
 33LL
 33HH
 33PP
 33QQ

 18/26/32 ton.

 4X2 4X4 6X4
 6X6 8X4

 6X4 8X4

 4X2 4X4 6X4

dCi 1
 11.1 ltr.
 195K W/265 HP
 230K W/313 HP
 266K W/362 HP
 303K W/412 HP

Front pipe

Silencer

Tail pipe

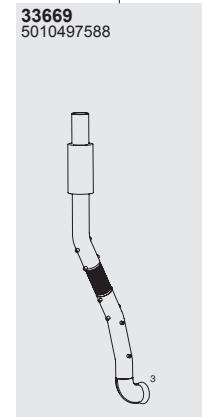
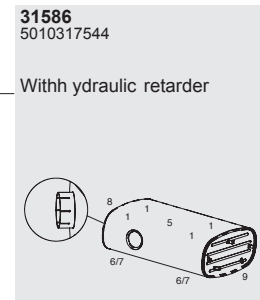
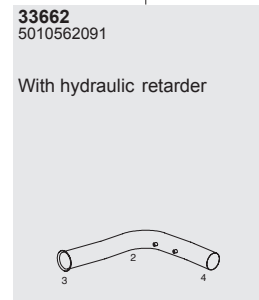
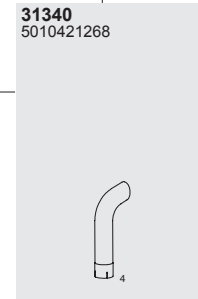
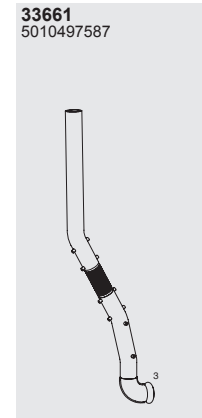
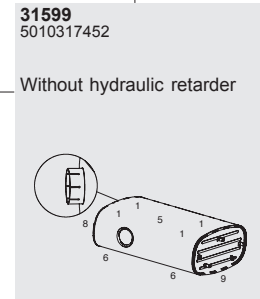
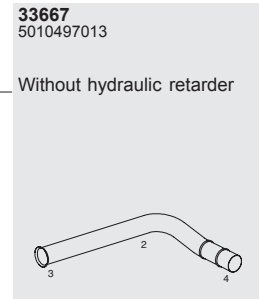
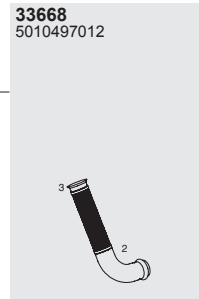
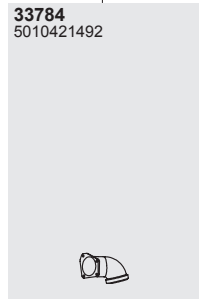

Mounting Parts

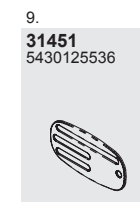
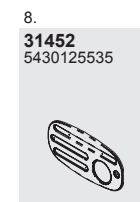
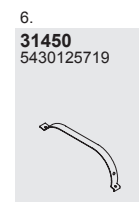
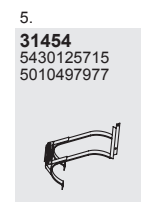
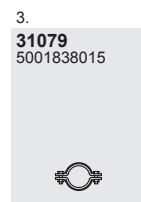
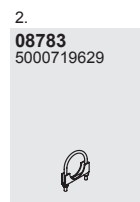
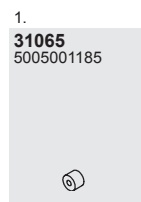

Vertical
 LHD/RHD
 Standard

Series **KERAX**

Type

Euro III

FAB 33A → S
2000 → 2002

33M
33N
33R
33S

18/26/32 ton.

 **4X2 4X4 6X6**
6X4 6X4

 **6X4 6X4**

 **6X4**

 **MIDR 06.20.45**
9.8l tr.
188K W/256H P
219K W/298H P
249K W/339H P

 **4X2 4X4 6X6**
6X4 6X4

 **6X4 6X4**

 **4X2 4X4 6X6**

 **MIDR 06.23.56**
11.1 ltr.
280K W/381H P
288K W/392H P

Front pipe

31699
5430122780



31784
5430127816
5430127482



31766
5010497522
5010317649



33684
5010317648

33M/N



Silencer

31594
5010317468

20.11.00 →

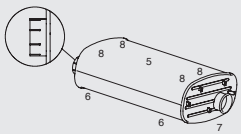

31593
5010317508
5010317534

20.11.00 →

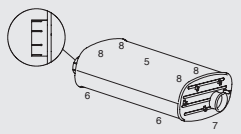

31587
5010317581

20.11.00 →

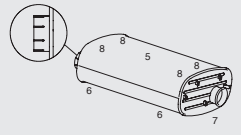

Mounting Parts

1.
31076
0000704037



2.
08780
5005034016
5000951555



3.
31079
5001838015



4.
00772
5010140898
0000798219
5010317399



5.
31454
5430125715
5010497977



6.
31450
5430125719



7.
31452
5430125535



8.
31065
5005001185



Horizontal
LHD/RHD
Standard

SOYLU / EURO I, II, III

SCANIA

93	298
113	302
143	310
4 Series	317
P, R, T Series	326

Series 93

Type

Euro II

1166899SSS
 ▶CHno

4290090SN
 ▶CHno

G93
 P93
 R93
 T93

Page 1/2
 Next page:
 (syst. 168100041)

Front pipe

Silencer

34738
1303221

G93: DS-DSC-engine (Turbo/intercooler), ④X②

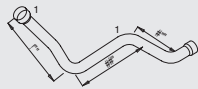

34741
1303204

T93: DN9-Engine
 801

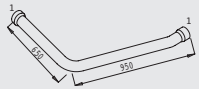

34679



34652

Alternative, L=100



34568
1302861
1338128
1338071

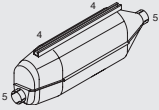

34731
1114168

P93, R93: DS-DSC-engine (Turbo/intercooler),
 801, ④X② ⑥X② ⑥X④ ⑥X②/④
 P93, R93(Cat.), W B 3800. 4200-6200.
 T93: DS-DSC-engine (Turbo/intercooler),
 ④X② ⑥X② ⑥X④

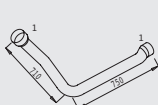

34687
1336131

P93: ④X② 93M, 93H.
 ⑥X② 93M, 93H.
 ⑥X④ 93M, 776



34737
1115282

L=300



34653

Alternative, L=210



34736
1115283

L=430



Mounting Parts

1.
34484
153474



2.
00171
1117067



3.
00768
1335720



4.
34470
1300367



5.
34468
1335618
1338273



Horizontal
 LHD
 Standard

Series 93

Type

Euro II



 116899SSS
 ▶CHno

4290090SN
 ▶CHno

G93
 P93
 R93
 T93

Page 2/2
 Previous page:
 (syst. 168100017)

Horizontal
 LHD
 Standard

Silencer

34568
 1302861
 1338128
 1338071
 TUV/KBA2 1196





Tail pipe

34310
 1114166

Standard



34325
 1121536

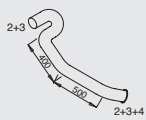

 rear







34330
 1320939

P93, R93
 WB 4700
 1x200l tr.t ank



34322
 1114161

 front
 WB 3400-3600, 3800, 4200-6200.
 P93, R93:
 front
 ML 
 1161081SSS ▶CHno .
 P93, R93:
 front / r ear

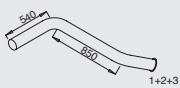
 1161081SSS ▶CHno

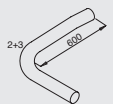

34329
 384321



34327
 1114159

 WB 3400-3600,
 3800, 4200-6200



34328
 1114157

G93, P93, R93:

 WB 3100



34312
 374113



34326
 1114153

 WB 3100, 3400-3800



Mounting Parts

1.
34474
 328928
 1384745



2.
34478
 215881
 1302844



3.
34477
 1114180
 207550
 1114182



4.
34088
 40607



5.
34470
 1300367



6.
34468
 1335618
 1338273



Series 93

Type

Euro II

G93
 P93
 R93
 T93

Front pipe

34686
1344785
389013

34688
1315204

Silencer

34568
1302861
1338128
1338071
TUV/KBA2 1196

34330
1320939

P93, R93: WB 5400-5900
2x300, 2x400l tr.t ank

34329
384321

P93, R93: WB 5400-5900
2x300& 2x400l tr.t ank

Tail pipe

34312
374113

34396
1329857
1319537

Mounting Parts

1.
34088
40607

2.
34477
1114180
207550
1114182

3.
34478
215881
1302844

4.
34474
328928
1384745

5.
00770

5. Alternative.
34470
1300367

6.
34468
1335618
1338273

Horizontal
LHD
Standard

Series 93

Type

Euro II

 1192433 SSS
▶CHno

9000673 SAN
▶CHno
DS-DSC9 engine
GR801

T93

Front pipe

34626
1345747



N.A.
1345756

34666
1335252

CT13 = 



Silencer

34565
1305509
1338160
1361983
84 db



Tail pipe

34336
1318583

▶CHno 1201284



34349
1168264

Ejector





34337
391112

▶CHno 1201284
Inox



34665
1335253

CT19 = 



34302
1363703

1201285 ▶CHno



34348
1315657

1201285 ▶CHno



Mounting Parts

1.
34474
328928
1384745



2.
34470
1300367



3.
00770



4.
34477
1114180
207550
1114182



Vertical
LHD
Standard

Series 113

Type

Euro II

1166899SSS
 ▶CHno
 4290090SN
 ▶CHno

P113
 R113
 T113

Page 1/2
 Next page:
 (syst. 168100035)

Horizontal
 LHD
 Standard

Front pipe

34732
1114170

P113,R 113: ④X②⑥X②⑥X④⑥X②/④
 T113: ④X②⑥X②⑥X④
 ▶ G770,G S771-772,G R-R871-T, GR-GRS900/R

34739
1303208

R113,T 113: ④X②⑥X②⑥X④
 ▶ GRH880

34733
1114174

P113,R 113: ④X②⑥X②.D SC11.T urbo. ▶
 ▶ G770,G S771-772,G R-E871-T, GR-GRS900/R

34682
1118481
1340024

R113: Streamline, DTC1 1. Turbo. ▶ GRS900

34685
1319277
1319257

Mounting Parts

1.
34468
1335618
1338273

2.
00171
1117067

3.
00768
1335720

4.
34470
1300367

5.
34477
1114180
207550
1114182

6.
34474
328928
1384745

Silencer

34737
1115282

L=300.
 Alternatives:
 68162L =430.
 68163L =800

34568
1302861
1338128
1338071
84db

34616
1351908

▶ GR-GRS900R
 L=987

34615
1351957

▶ GR-GRS900R,
 L=915

34679
Alternative

34652
L=100.
 Alternatives:
 68236L =210.
 68237L =620

Series 113

Type

Euro II



 1166899SSS
 ▶CHno

4290090SN
 ▶CHno

P113
 R113
 T113

Page 2/2
 Previous page:
 (syst. 168100010)

Horizontal
 LHD
 Standard

Silencer

Tail pipe

34568
 1302861
 1338128
 1338071
84 db

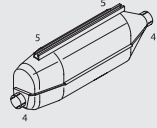

34310
 1114166



34391
 1342951

P113,R 113, T113:

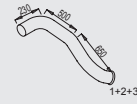
 WB 3100
 1187685SSS ▶CHno
 4320442SN ▶CHno
 9000065SAN ▶CHno



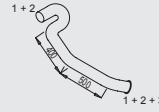

34325
 1121536

P113,R 113:

 rear



34327
 1114159

P113,R 113, T113:

 WB 3400-3600, 3800, 4200-6200
 ▶CHno 1187681SSS
 ▶CHno 4320441SN
 ▶CHno 9000064SAN



34328
 1114157

P113,R 113:

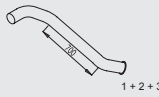
 WB 3100



34340
 1333650

P113,R 113, T113:

 WB 3600, 3800

 1185715SSS ▶CHno
 4318979SN ▶CHno



34326
 1114153

P113,R 113:

 WB 3100, 3400-3800
 ▶CHno 1187684SSS
 ▶CHno 4320441SN
 ▶CHno 9000064SAN



34322
 1114161

P113,R 113, T113:

 WB 3400-3600, 3800, 4200-6200
 1187685SSS ▶CHno
 4320442SN ▶CHno
 9000065SAN ▶CHno

 front.
 P113,R 113:

 front/rear



Mounting Parts

1.
34478
 215881
 1302844



2.
34477
 1114180
 207550
 1114182



3.
34088
 40607



4.
34470
 1300367



5.
34468
 1335618
 1338273



Series 113

Type

Euro II

 
1166899SSS
▶CHno

4290090SN
▶CHno

P113
R113
T113

Page 2/2
Previous page:
(syst. 168100010)

Horizontal
LHD
Standard

Silencer

34568
1302861
1338128
1338071
84db

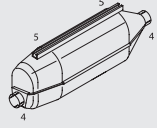

Tail pipe

34310
1114166



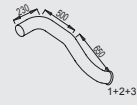

34391
1342951

P113,R 113, T113:
 WB 3100
1187685SSS ▶CHno
4320442SN ▶CHno
9000065SAN ▶CHno



34325
1121536

P113,R 113:
 rear



34327
1114159

P113,R 113, T113:
 WB 3400-3600, 3800, 4200-6200
▶CHno 1187681SSS
▶CHno 4320441SN
▶CHno 9000064SAN



34328
1114157

P113,R 113:
 WB 3100

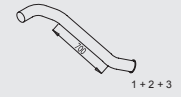

34340
1333650

P113,R 113, T113:
  WB 3600, 3800
 1185715SSS ▶CHno
4318979SN ▶CHno



34326
1114153

P113,R 113:
 WB 3100, 3400-3800
▶CHno 1187684SSS
▶CHno 4320441SN
▶CHno 9000064SAN



34322
1114161

P113,R 113, T113:
 WB 3400-3600, 3800, 4200-6200
1187685SSS ▶CHno
4320442SN ▶CHno
9000065SAN ▶CHno
 front.
P113,R 113:
  front/rear



Mounting Parts

1.
34478
215881
1302844



2.
34477
1114180
207550
1114182



3.
34088
40607



4.
34470
1300367



5.
34468
1335618
1338273



Series 113

Type

Euro II



P113
R113

Front pipe

Silencer

Tail pipe

34628
1364021

113M WB 3600, 3800, low chassis
1199484SSS ▶CHno
4334055SNL ▶CHno
90002352SAN ▶CHno

34679

34652
L=100

34565
1305509
1338160
1361983
84 db

34398
1337664

P113, R 113 WB 3600,

34392
1329735
1331800

113M WB 3600, 3800, low chassis
Voith-/Telma Retrader

34383
1324800

113M WB 3600, 3800, low chassis
▶CHno 1193611SSS
(Voith-/Telma etader)

34612
1364025
L=185

34653
L=210

34397
1335294

113M, WB 3600, 3800,
1185715SSS ▶CHno
4318979SN ▶CHno

34659
L=620

34682
1118481
1340024

113M WB 3600, 3800
DTC1 1T urbo compound-engine

34675
1331833

Mounting Parts

1.
34477
1114180
207550
1114182

2.
34470
1300367

3.
34088
40607

4.
34460
1315559

5.
00768
1335720

6.
34478
215881
1302844

7.
34454
1319879

8.
00171
1117067

Horizontal
LHD
Standard

Series 113

Type

Euro II



P113
R113

Front pipe

Silencer

Tail pipe

34732
1114170

113M.1 13H: WB 3600, 3800
113M: low chassis
WB 3600, 3800
 GR-GRS900/R
1133612SSS CHno

34619
1349196

WB 3600

34565
1305509
1338160
1361983
84 db

34310
1114166

WB 3600

34614
1349198

WB 3800

34305
1349199

WB 3800
1x560l tr.t ank

34398
1337664

WB 3800

Mounting Parts

1.
34477
1114180
207550
1114182

2.
34470
1300367

3.
34088
40607

4.
00171
1117067

5.
34450
1349938

6.
34468
1335618
1338273

7.
34478
215881
1302844

Horizontal
LHD
Standard

Series 113

Type

Euro II



R113

Front pipe

Silencer

Tail pipe

34681
1327856

GR-GRS900

34688
1315204

34568
1302861
1338128
1338071
TUV/KBA2 1196

34330
1320939

WB 4700
1x200l tr.t ank.
WB 5400-5900
2x300l tr., 2x400l tr.t ank

34329
384321

WB 4700
1x200l tr.t ank.
WB 5400-5900
2x300, 2x400l tr.t ank

34312
374113

34793
346617

GRH880

34396
1329857
1319537

Mounting Parts

1.
34088
40607

2.
34477
1114180
207550
1114182

3.
34478
215881
1302844

4.
34474
328928
1384745

5.
00770

5. Alternative.
34470
1300367

6.
34468
1335618
1338273

Horizontal
LHD
Standard

Series 113

Type

Euro II

RL
P93
R93
P113
R113

Front pipe

Silencer

Tail pipe

34663
1335503

P113,R 113, GR-GRS900, 4X2 6X2 6X4 6X2/4 8X2 8X4



34661
1335361



34679



34674
1315184



34565
1305509
1338160
1361983
84db

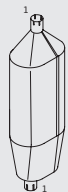

34348
1315657



34669
1335504

P93H, GR-GRS900, 4X2 6X2 6X4 6X2/4 8X2 8X4

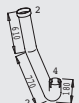

34662
1335363



34657
1315641

P113,R 113 4X2 6X2 6X4 8X2 8X4



34671
1315181



34708
1107155

P93, R93, 4X2 6X2 6X4 8X2 8X4

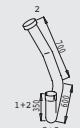

34672
1319018



34673
1319020



Mounting Parts

1.
34470
1300367



2.
34477
1114180
207550
1114182



3.
34478
215881
1302844



4.
34474
328928
1384745



5.
48497



Vertical
LHD
Standard

Series 113

Type

Euro II



T93
DS-DSC9 engine

T113
DS-DSC11 engine

Front pipe

34708
1107155

T93

34670
385759

T113

34740
397383

34742
1318593

CT13 =

34627
1325928
1345756

T93H P
High chassis

34707
1325929

T113 HP
High chassis

34749
353031

34743
1318595

CT19 =

Silencer

34565
1305509
1338160
1361983

Tail pipe

34336
1318583

►CHno 1201284

34337
391112

►CHno 1201284,
Inox

34349
1168264

Ejector

34302
1363703

1201285 ►CHno

34348
1315657

1201285 ►CHno

Mounting Parts

1.
34478
215881
1302844

2.
34477
1114180
207550
1114182

3.
48497

4.
34470
1300367

5.
34474
328928
1384745

6.
34484
153474

Vertical
LHD
Standard

Series 143

Type

Euro II

1166899SSS
 ▶CHno

4290090SN
 ▶CHno

R143
 T143

Page 1/2
 Next page:
 (syst. 168100037)

Horizontal
 LHD/RHD
 Standard

Front pipe

34730
1303210

GRH 880 ④X② ⑥X② ⑥X④

34736
1347402

GRH 900 ④X② ⑥X② ⑥X④

34734
1114172
1341733
1348179

GR 880-T, GRS900, ④X② ⑥X② ⑥X④ ⑥X②/④

34737
1115282

L=300 mm

34660
1115283

L=430 mm

34735
1115284

L=800 mm

34679

34616
1351908

GR-GRS900R
L=987

34615
1351957

GR-GRS900R
L=915

34652

Alternative L=100

34653

Alternative L=210

34659

Alternative L=620

Silencer

34568
1302861
1338128
1338071
84dbTUV/KBA2 1196

Mounting Parts

1.
34468
1335618
1338273

2.
34477
1114180
207550
1114182

3.
00171
1117067

4.
00768
1335720

5.
00770

5. Alternative.
34470
1300367

Series 143

Type

Euro II

1166899SSS
▶CHno

4290090SN
▶CHno

R143
T143

Page 2/2
Previous page:
(syst. 168000049)

Horizontal
LHD
Standard

Silencer

34568
1302861
1338128
1338071
84dbTUV/KBA2 1196

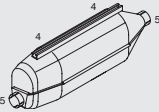

Tail pipe

34310
1114166



34328
1114157

R143:
WB 3100



34391
1342951

WB 3100
187685SSS ▶CHno
4320442SNL ▶CHno
9000065SAN ▶CHno



34340
1333650

WB 3600, 3800
1185715 SSS ▶CHno
4318979 ▶CHno



34326
1114153

WB 3100
1187684SSS ▶CHno
4320441SNL ▶CHno
9000064SAN ▶CHno
WB 3400-3800



34325
1121536

R143:
rear

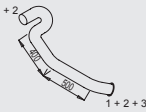

34308

Special end pipe

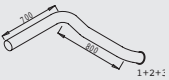

34322
1114161

R143.T 143:
WB 3400-3600, 3800, 4200-6200
1187684SSS ▶CHno
4320441SNL ▶CHno
9000064SAN ▶CHno
front.

R143 ML:
1161081SSS ▶CHno



34327
1114159

R143.T 143:
WB 3400-3600, 3800, 4200-6200
1187684S SS ▶CHno
4320441 SNL ▶CHno
9000064S AN ▶CHno
front

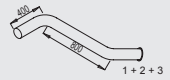

Mounting Parts

1.
34088
40607



2.
34477
1114180
207550
1114182



3.
34478
215881
1302844



4.
34468
1335618
1338273



5.
00770



5. Alternative.
34470
1300367



Series 143

Type

Euro II



R143

Front pipe

Silencer

Tail pipe

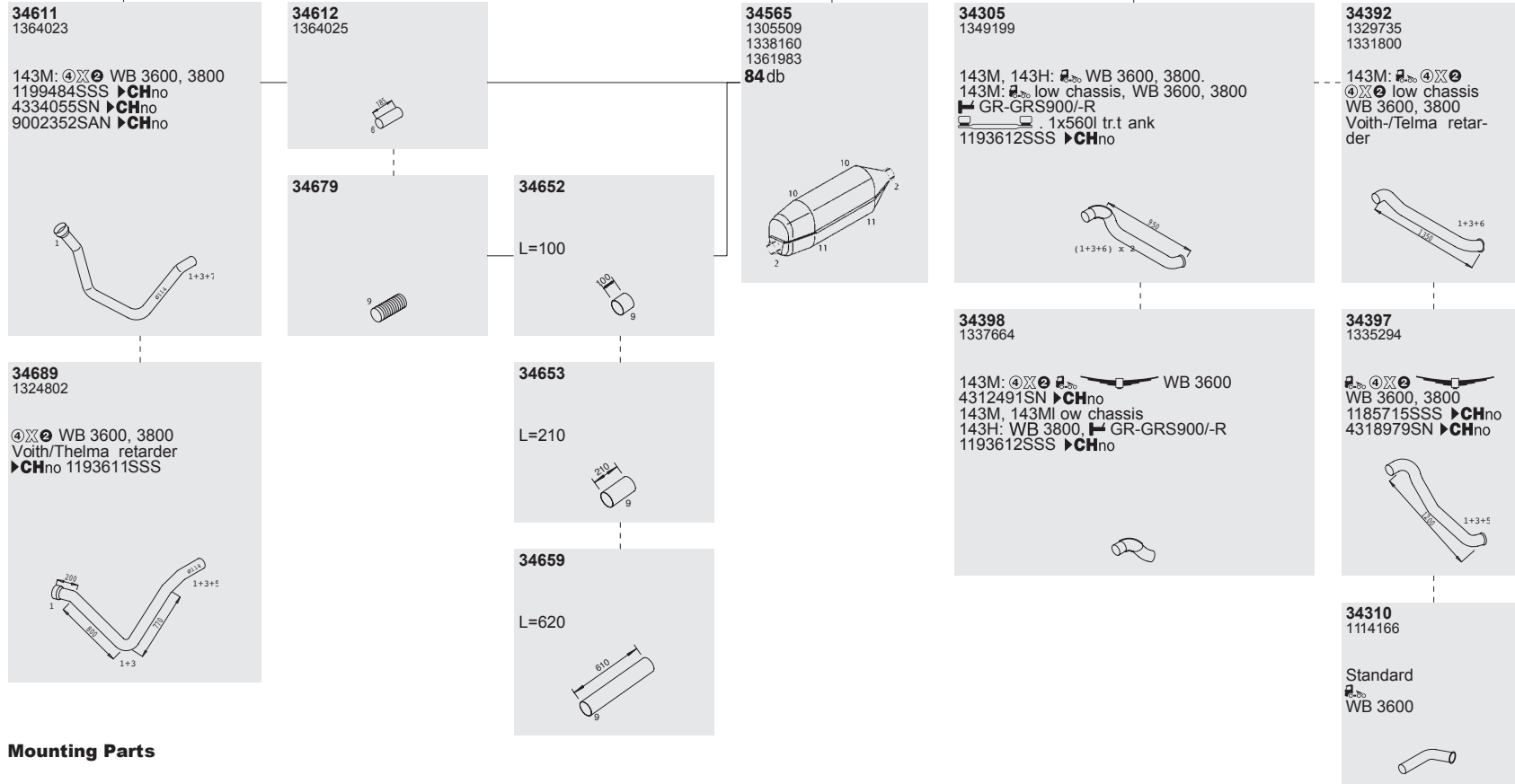

Mounting Parts

- | | | | | | | | | | |
|-------------------------------|-------------------------------|-----------------------------|-------------------------------|---|-------------------------------|-------------------------------|-------------------------------|---|--------------------------------|
| 1.
34466
1300367 | 2.
34470
1300367 | 3.
34088
40607 | 5.
34467
1335299 | 6.
34478
215881
1302844 | 7.
34454
1319879 | 8.
00171
1117067 | 9.
00768
1335720 | 10.
34468
1335618
1338273 | 11.
34450
1349938 |
|-------------------------------|-------------------------------|-----------------------------|-------------------------------|---|-------------------------------|-------------------------------|-------------------------------|---|--------------------------------|

Horizontal
LHD
Standard

Series 143

Type

Euro II



R143

Front pipe

34734
1114172
1341733
1348179
lowc hassis
WB 3600, 3800
GR-GRS900-R
1193612SSS ▶CHno

34619
1349196
WB 3600

34614
1349198
WB 3800

Silencer

34565
1305509
1338160
1361983

34305
1349199
143M, 143H, lowc, WB 3600, 3800
143M lowc hassis, WB 3600, 3800
GR-GRS900-R
1x560l tr.t ank
1193612 ▶CHno

34392
1329735
1331800
143M, lowc, WB 3600, 3800
Voith-/Telmar etarder

Tail pipe

34397
1335294
143M, WB 3600, 3800
1185715SSS ▶CHno
4318979SN ▶CHno

34398
1337664
143M, WB 3600
4312491SN ▶CHno
143M, 143M lowc hassis
143H, W B 3800
GR-GRS900-R
1193612SSS ▶CHno

34310
1114166
WB 3600

Mounting Parts

1.
34466
1300367

2.
34470
1300367

3.
34088
40607

4.
34468
1335618
1338273

5.
34467
1335299

6.
34478
215881
1302844

7.
34450
1349938

8.
00171
1117067

Horizontal
LHD
Standard

Series 143

Type

Euro II

Ⓜ
Ⓧ
Ⓧ

R143

Front pipe

Silencer

Tail pipe

34797
333423

GRS900

34688
1315204

34568
1302861
1338128
1338071

34330
1320939

WB 4700
1x200l tr.t ank.
WB 5400-5900
2x300, 2x400l tr.t ank

34329
384321

WB 4700
1x200l tr.t ank.
WB 5400-5900
2x300l tr., 2x400l tr.t ank

34312
374113

WB 4700
1x200l tr.t ank.
WB 5400-5900
2x300, 2x400l tr.t ank

34613
1348941
1348981

GR-GRS900
1190253SSS ▶CHno,
4324154SN ▶CHno,
Dual circuits tearing

34396
1329857
1319537

34796
335924

GRH880

Mounting Parts

1.
34088
40607

2.
34477
1114180
207550
1114182

3.
34478
215881
1302844

4.
34474
328928
1384745

5.
00770

5. Alternative.
34470
1300367

6.
34468
1335618
1338273

Horizontal
LHD
Standard

Series 143

Type

Euro II

-
-
-
-
-
-
- GRH900
- 84**db

R143

Front pipe

34668
1315643

CR13=



34679



34674
1315184



Silencer

34565
1305509
1338160
1361983



Tail pipe

34348
1315657



34667
1332957

CR19=



34343
1322044

Ejector

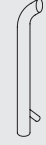

Mounting Parts

1.
34477
1114180
207550
1114182



2.
00578



3.
34470
1300367



Vertical
LHD
Standard

Series 143

Type

Euro II

 DSC14 engine

T143

Front pipe

34744
397381



34794
353031



34742
1318593

CT13, 



34743
1318595

CT19, 



Silencer

34765
1305509
1338160
1361983
84 db



Tail pipe

34336
1318583

►CHno 1201284



34349
1168264

Ejector



34337
391112

►CHno 1201284
Inox



34302
1363703

1201285 ►CHno



34348
1315657

1201285 ►CHno



Mounting Parts

1.
34477
1114180
207550
1114182



2.
00578



3.
34470
1300367



4.
34088
40607



5.
34474
328928
1384745



Vertical
LHD
Standard

Series 4 SERIES

Type

Euro II/III



C144
G144
L144

Front pipe

34650
1428892
1364355



34618
1364290



34617
1364288

144s eries



34692
1482615

144s eries
Underr un
protection



34693
1502090

144s eries



Silencer

34569
1420278
1378553
1500455

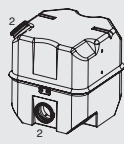

Tail pipe

34936
1375814

   ,E jector



34937
1375817

Ejector,
high chassisL +E



34303
1344153



34938
1375811

Ejector,
high chassisN +H



34986
1405350
1483280

80db ACC.92/97 EEC.
235759SSS ▶**CH**no
4385405SNL ▶**CH**no
9028648SAN ▶**CH**no
ADR:
1248285SSS ▶**CH**no
4408570SNL ▶**CH**no
9040439SAN ▶**CH**no

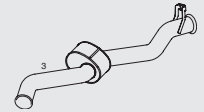

34307
1373201
1397273

80dB ACC.92/97 EEC
ADR:
▶**CH**no 1235758SSS
▶**CH**no 4385404SNL
▶**CH**no 9028647SAN

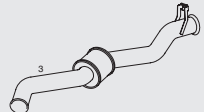

34306
1397052
1344151
1483278



Mounting Parts

1.
34453
1360294



2.
34452
1335618
1422474
1387136



3.
34459
1344150



3A.
34433
1514959



Horizontal
LHD
Standard

Series 4 SERIES

Type

Euro II/III



C94
C114
C124

D94

G94
G114
G124

L94
L114
L124

Front pipe

34695
1477000
1505748

94, 114, 124 serie
1278128SSS ▶CHno
4466697SNL ▶CHno
9067911SAN ▶CHno
3532582SLA ▶CHno
Engine D9, DC11
DT12,DSC/DC12

34650
1428892
1364355

34618
1364290

34623
1364358

94 series
▶CHno 1240179

34631
1413619

94 series
1240180 ▶CHno

34654
1364356

114, 124 series

34629
1380748

114 series
Turbo intercooler

Mounting Parts

1.
34453
1360294

2.
34452
1335618
1422474
1387136

3.
34459
1344150

3A.
34433
1514959

Horizontal
LHD
Standard

Silencer

34569
1420278
1378553
1500455

Tail pipe

34936
1375814

② ③ ④ ⑤ ⑥ ⑦ ⑧ ⑨ ⑩ ⑪ ⑫ ⑬ ⑭ ⑮ ⑯ ⑰ ⑱ ⑲ ⑳ ㉑ ㉒ ㉓ ㉔ ㉕ ㉖ ㉗ ㉘ ㉙ ㉚ ㉛ ㉜ ㉝ ㉞ ㉟ ㊱ ㊲ ㊳ ㊴ ㊵ ㊶ ㊷ ㊸ ㊹ ㊺ ㊻ ㊼ ㊽ ㊾ ㊿

Ejector

34307
1373201
1397273

80dB ACC.92/97 EEC
Incl. ADR
▶CHno 1235758SSS
▶CHno 4385404SNL
▶CHno 9028647SAN

34303
1344153

34986
1405350
1483280

80db ACC.92/97 EEC.
235759SSS ▶CHno
4385405SNL ▶CHno
9028648SAN ▶CHno
Incl. ADR
1248285SSS ▶CHno
4408570SNL ▶CHno
9040439SAN ▶CHno

34937
1375817

Ejector,
high chassisL +E

34938
1375811

Ejector,
high chassisN +H

34306
1397052
1344151
1483278

Series 4 SERIES

Type

Euro II/III



C94
C114
C124
C144

D94

G94
G114
G124
G144

L94
L114
L124
L144

Page 1/2
Next Page:
(syst. 168101009)

Vertical
LHD
Standard

Front pipe

Silencer

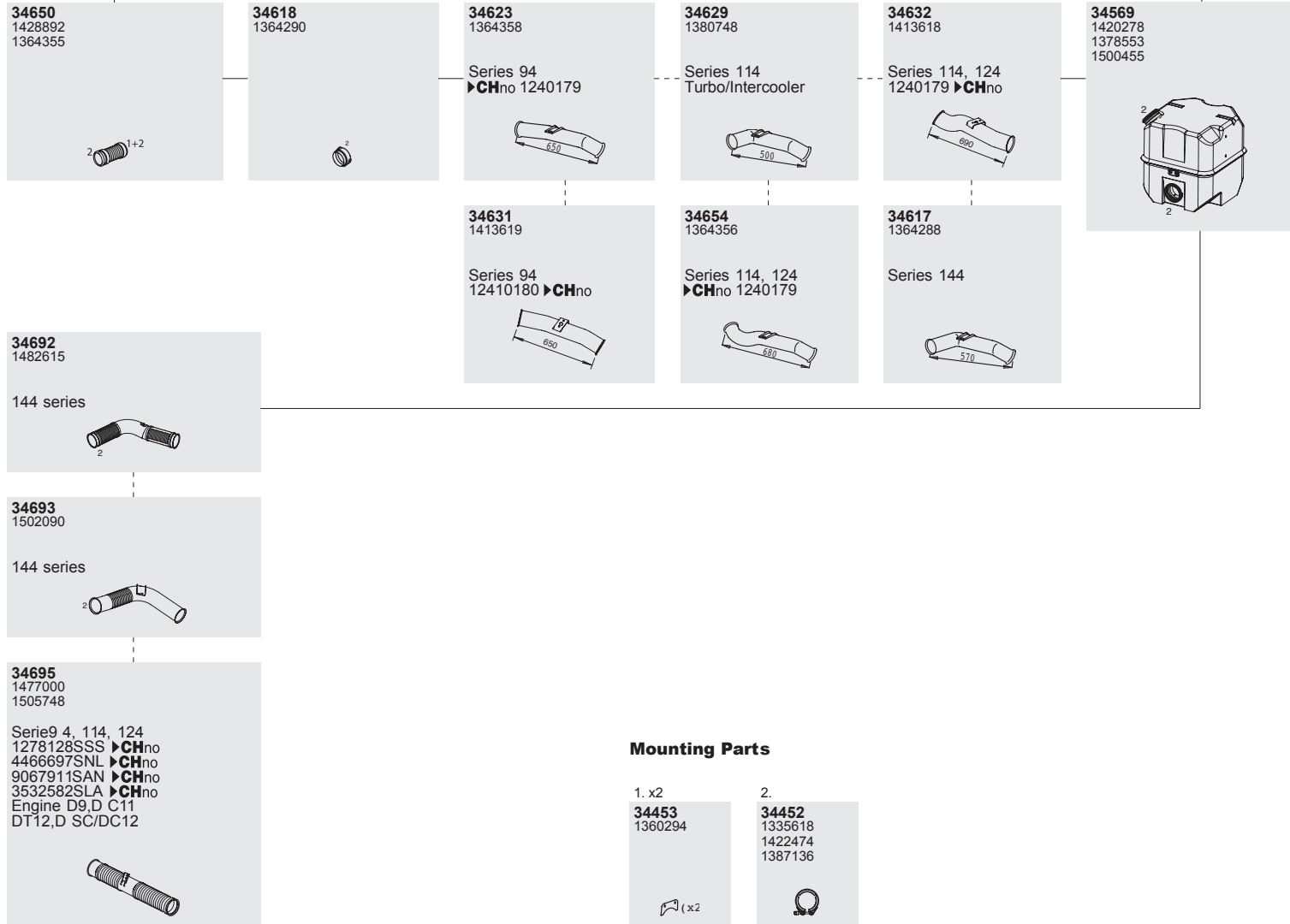

Series 4 SERIES

Type

Euro II/III



C94
C114
C124
C144

D94

G94
G114
G124
G144

L94
L114
L124
L144

Page 2/2
Previous page:
(syst. 168101008)

Vertical
LHD
Standard

Silencer

34569
1420278
1378553
1500455

34984
1413893
1340470

34985
1413892

34930
1409822
1340463

34989
1427839

1242206SSS ▶CHno
4397542SNL ▶CHno
9034865SAN ▶CHno

34931
1340461

34933
1340462

Tail pipe

34939
1340469

L=570 mm

34418
1395727

34934
1340468

L=900mm

34427
1413633

1242206SSS ▶CHno
4397542SNL ▶CHno
9034865SAN ▶CHno

Mounting Parts

1.
34474
328928
1384745

1. Inox
34428
1420480

2.
34452
1335618
1422474
1387136

Series 4 SERIES

Type

Euro II/III



164

Front pipe

34698
1387983



34630
1387982



34696
1433667
529196



Silencer

34553
1387823
1497013

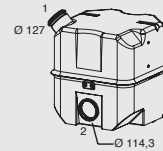

Tail pipe

34979
1445905
1445925
1483281

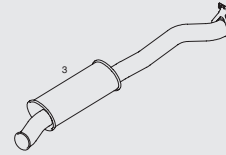

Mounting Parts

1.

34424
1431579



2.

34452
1335618
1422474
1387136



3.

34438
1446097



Horizontal
LHD
Standard

Series 4 SERIES

Type

Euro II / III
1996 → 2004
CT14,C T19

C94
D94
G94
L94
DC 9
DSC9
9,0l tr.
6 cyl.
162K W/220H P
169K W/230H P
191K W/260H P
220K W/300H P
228K W/310H P

C114
G114
L114
DC11
10,6l tr.
6 cyl.
250K W/340H P
280K W/380H P

C 124
G124
L124
DC 12
DSC1 2
11,7 ltr.
6 cyl.
265K W/360H P
294K W/400H P
309K W/420H P

C144
G144
L144
DSC1 4
14,1l tr.
V8 cyl.
338K W/460H P
391K W/530H P

Vertical
LHD/RHD
Standard

Front pipe

34650
1428892
1364355



34618
1364290



Mounting Parts

1.
34452
1335618
1422474
1387136



2.
34453
1360294



34631
1413619

1240180S SS ▶CHno
4393485 SNL ▶CHno
9033532S AN ▶CHno

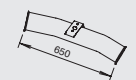

34654
1364356

▶CHno 1240179S SS
▶CHno 4393484S NL
▶CHno 9033531S AN



34623
1364358

▶CHno 1240179S SS
▶CHno 4393484S NL
▶CHno 9033531S AN

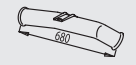

34617
1364288

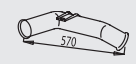

Silencer

34569
1420278
1378553
1500455

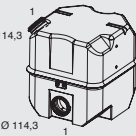

34984
1413893
1340470



34289
1487830



34985
1413892



34976
1427838

CT 19:
1247100S SS ▶CHno
4406577S NL ▶CHno
CT14:
1241770S SS ▶CHno
4396498S NL ▶CHno

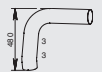

34289
1487830



34985
1413892



Tail pipe

34980
1405298

CT 14



34278
1728100
1422766

CT 19



3.
34428
1420480



3. Alternative.
34474
328928
1384745



4.
00067
1779825
1445015



34934
1340468

L=900 mm,
steel



34939
1340469

L=570 mm,
steel



34987
1397607

L=1135 mm,
steel



Series 4 SERIES

Type

Euro II / III
1996 → 2004
CP19,CR19

C94
D94
G94
L94
DSC9
9l tr.
6 cyl.
162K W/220H P
169K W/230H P
191K W/260H P
228K W/310H P

C114
G114
L114
DC11
10,6l tr.
6 cyl.
250K W/340H P
280K W/380H P

C124
G124
L124
DC 12
DSC 12
11,7 ltr.
6 cyl.
265K W/360H P
294K W/400H P
309K W/420H P

C144
G144
L144
DSC1 4
14,1l tr.
V8 cyl.
338K W/460H P
391K W/530H P

Vertical
LHD/RHD
Standard

Front pipe

34650
1428892
1364355



34631
1413619

1240180 SSS ▶CHno
4393485 SNL ▶CHno
9033532 SAN ▶CHno

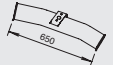

34618
1364290



34654
1364356

▶CHno 1240179 SSS
▶CHno 4393484 SNL
▶CHno 9033531 SAN



34623
1364358

▶CHno 1240179 SSS
▶CHno 4393484 SNL
▶CHno 9033531 SAN



34617
1364288



Silencer

34569
1420278
1378553
1500455

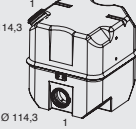

34984
1413893
1340470



34289
1487830

170 mm



34985
1413892

140 mm



34284
1515905



34273
1741818



34283
1515906

3515886S LA ▶CHno
1253434 SSS ▶CHno
4418947S NL ▶CHno

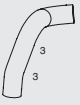

Tail pipe

34939
1340469

L=570 mm,
steel



34934
1340468

L=900 mm,
steel



34887
1397607

L=1135 mm,
steel



Mounting Parts

1.
34452
1335618
1422474
1387136



2.
34453
1360294

(x2)



3. Alternative.
34474
328928
1384745



3.
34428
1420480



4.
00067
1779825
1445015



5.
34498
1722843



Series 4 SERIES

Type

Euro II / III
1996 → 2004
CP14, CR14

C94
D94
G94
L94
DC 9
DSC9
9,0l tr.
6 cyl.
162K W/220H P
169K W/230H P
191K W/260H P
221K W/300H P
228K W/310H P

C114
G114
L114
DC11
10,6l tr.
6 cyl.
250K W/340H P
280K W/380H P

C124
G124
L124
DC 12
DSC1 2
11,7 ltr.
6 cyl.
265K W/360H P
294K W/400H P
309K W/420H P

C144
G144
L144
DSC1 4
14,2l tr.
V8 cyl.
338K W/460H P
391K W/530H P

Vertical
LHD/RHD
Standard

Front pipe

34650
1428892
1364355



34618
1364290



34617
1364288

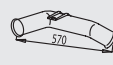

34631
1413619
1240180 SSS ▶CHno
4393485 SNL ▶CHno
9033532 SAN ▶CHno



34654
1364356
▶CHno 1240179S SS
▶CHno 4393484 SNL
▶CHno 9033531S AN



34623
1364358
▶CHno 1240179S SS
▶CHno 4393484 SNL
▶CHno 9033531S AN



34632
1413618
1240180 SSS ▶CHno 1277992 SSS
4393485 SNL ▶CHno 4466324 SNL
9033532 SAN ▶CHno 9067727S AN
▶CHno 3532763S LA



Silencer

34569
1420278
1378553
1500455



34931
1340461
▶CHno 1242205 SSS
▶CHno 4397541 SNL
▶CHno 9034864 SAN



34984
1413893
1340470
1242206S SS ▶CHno
4397542S NL ▶CHno
9034865S AN ▶CHno



Mounting Parts

1.
34452
1335618
1422474
1387136



2.
34453
1360294

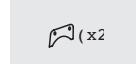

34933
1340462



34418
1395727



34427
1413633

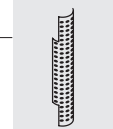

3.
34428
1420480



34384
1420848
L=550 mm



34939
1340469
L=570 mm
Inox

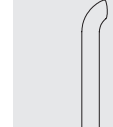

34995
1384755
L=311 mm
Inox



3. Alternative.
34474
328928
1384745



Tail pipe

34389
1420847
L=900 mm
Inox



34934
1340468
L=900 mm



34987
1397607
L=1135 mm,
Inox

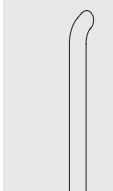

Series 4 SERIES

Type

Euro III
05.2000 → 2004

CP19, CR19

C164
G164
L164

DC 16
16.2l tr.
V8 cyl.
353K W/480H P
426K W/580H P

Front pipe

34698
1387983

►CHno 1289937 SSS
►CHno 4495079 SNL
►CHno 9080902 SAN
►CHno 3543033S LA

D16

34630
1387982

34696
1433667
529196

NA
1431693

34694
1488556

1289938 SSS ►CHno 2002333S SS
4495080 SNL ►CHno 5106746 SNL
9080903 SAN ►CHno 9092530 SAN
3543034S LA ►CHno

DC16

Silencer

34553
1387823
1497013

34984
1413893
1340470

34284
1515905

34273
1741818

34283
1515906

1253434S SS ►CHno
4418947 SNL ►CHno
3515886S LA ►CHno

34930
1409822
1340463

1239800S SS ►CHno
4392551 SNL ►CHno
9032215S AN ►CHno

Tail pipe

34939
1340469

L- 570mm
Inox

34934
1340468

L- 900mm
Inox

34987
1397607

L- 1135mm
Inox

Mounting Parts

1.
34424
1431579

2.
34452
1335618
1422474
1387136

3. Alternative.
34474
328928
1384745

3.
34428
1420480

4.
00067
1779825
1445015

5.
34498
1722843

34985
1413892

34289
1487830

Vertical
LHD/RHD
Standard

Series P, R, T

Type

Euro III
03.2004 →

18/19 ton.
23,8/25,7t on.
26 ton.

P230,P270,P310,
P340,P380
R230,R310,R340,
R380,R420,
R470,
R480,R500
T470

④X②⑥X②/②
⑥X②/④⑥X④

④X②⑥X②
⑥X②/④⑥X④

⑥X②

☞ DC 9
8,9l tr
169K W/230H P
198K W/270H P
228K W/310H P

☞ DC 11
10,6l tr.
250K W/340H P
279K W/380H P

☞ DC 12
11,7 ltr.
309K W/420H P

☞ DT 12
11,7 ltr
345K W/470H P

☞ DC 16
15,6l tr
368K W/500H P
426K W/580H P

Horizontal
LHD/RHD
Standard

Front pipe

34759
1533946

D9,D 11,D 12
AWD
1291877 SSS ▶CHno
3544688S LA ▶CHno
4500365 SNL ▶CHno
9083195 SAN ▶CHno



34849
1726291

D9,D 11,D 12
AWD
Air intake rear,
high mounted
1291877 SSS ▶CHno
3544688S LA ▶CHno
4500365 SNL ▶CHno
9083195 SAN ▶CHno



34806
1753639



34849
1726291



34699
1505749

DC 9/11/12

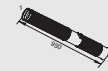

34695
1477000
1505748

DT 12

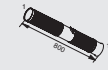

34808
1484095

DC 16
2002334 SSS ▶CHno
5106747 SNL ▶CHno
9092531 SAN ▶CHno



34807
1734040



Silencer

34569
1420278
1378553
1500455

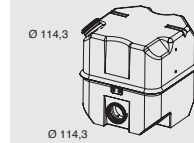

Mounting Parts

1.
34452
1335618
1422474
1387136



2.
34438
1446097



3.
34424
1431579



Tail pipe

34986
1405350
1483280

D11, D12, D16
80/82 dB
▶CHno 2010136S SS
▶CHno 5128409S NL
▶CHno 9102002S AN

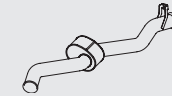

34306
1397052
1344151
1483278

D11, D12, D16
▶CHno 2010136S SS
▶CHno 5128409S NL
▶CHno 9101002S AN



34971
1435720
1483286

POINTING DOWN TO THEIR EARE /L



34975
1400987

RIGHTWARDS



34979
1445905
1445925
1483281

D16
▶CHno 2010136S SS
▶CHno 5128409S NL
▶CHno 9102002S AN

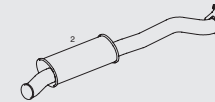

34974
1510575

2010137 SSS ▶CHno 2014271S SS
5128410 SNL ▶CHno 5139835 SNL
9102003 SAN ▶CHno 9106792S AN

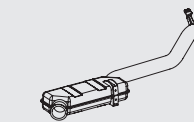

34968
1549217
1780120

2014272 SSS ▶CHno
5139836S NL ▶CHno
9106793 SAN ▶CHno

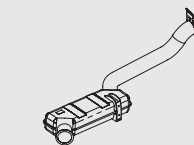

Series P, R, T

Type

Euro III
03.2004 →

18/19 ton.
23,8/25,7t on.
26 ton.

P230,P270,P310,
P340,P380
R230,R310,R340,
R380,R420,R470
R480,R500,
T470

4X2 6X2/2
6X2/4 6X4
 4X2 6X2
6X2/4 6X4
 6X2

DC 9
8,9l tr.
169K W/230H P
198K W/270H P
228K W/310H P

DC 11
10,6l tr.
250K W/340H P
279K W/380H P

DC 12
11,7 ltr.
309K W/420H P

DT 12
11,7 ltr.
345K W/470H P

DC 16
15,6l tr.
368K W/500H P
426K W/580H P

Horizontal
LHD/RHD
Standard

Front pipe

34844
1547488
1771141

34849
1726291

34807
1734040

Silencer

34569
1420278
1378553
1500455

34806
1753639

AWD

34842
1726289

AWD
Airi ntake rear,
high-mounted

Tail pipe

34986
1405350
1483280

80/82 dB
▶CHno 2010136S SS
▶CHno 5128409 SNL
▶CHno 9102002S AN

34979
1445905
1445925
1483281

D16
▶CHno 2010136 SSS
▶CHno 5128409S NL
▶CHno 9102002 SAN

34306
1397052
1344151
1483278

▶CHno 2010136S SS
▶CHno 5128409 SNL
▶CHno 9102002S AN

34974
1510575

2010137S SS ▶CHno 2014271S SS
5128410 SNL ▶CHno 5139835S NL
9102003 SAN ▶CHno 9106792S AN

34971
1435720
1483286

POINTING DOWN TO THER EAR
E/L

34968
1549217
1780120

2014272S SS ▶CHno
5139836 SNL ▶CHno
9106793S AN ▶CHno

Mounting Parts

1.
34452
1335618
1422474
1387136

2.
34438
1446097

34975
1400987

RIGHTWARDS

Series P, R, T

Type

Euro III
03.2004 →

18/19 ton.
23,8/25,7t on.

R500,R 580

④X②
⑥X②
⑥X②/④

DC16
15,6l tr.
368K W/500H P
426K W/580H P

Front pipeT

34690
1488557

DC 16
▶CHno 2002333 SSS
▶CHno 5106746 SNL
▶CHno 9092530 SAN

Silencer

34553
1387823
1497013

ail pipe

34974
1510575

2010137 ▶CHno 2014271 SSS
5128410 ▶CHno 5139835 SNL
9102003 ▶CHno 9106792 SAN

34979
1445905
1445925
1483281

▶CHno 2010136S SS
▶CHno 5128409S NL
▶CHno 9102002S AN

34986
1405350
1483280

80/82 dB
▶CHno 2010136 SSS
▶CHno 5128409 SNL
▶CHno 9102002 SAN

34306
1397052
1344151
1483278

▶CHno 2010136S SS
▶CHno 5128409S NL
▶CHno 9102002S AN

34975
1400987

RIGHTWARDS

34971
1435720
1483286

POINTING DOWN TO THER EARE /L

Mounting Parts

1.
34452
1335618
1422474
1387136

2.
34424
1431579

3.
34438
1446097

Horizontal
LHD/RHD
Standard

Series P, R, T

Type

Euro III
03.2004 →

18/19/23,8t on.
26/32 ton.

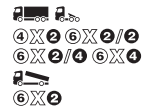

CP14
CP19
CR19

DC9
8,9l tr.
169K W/230H P
198K W/270H P
228K W/310H P

DC11
10,6l tr.
250K W/340H P
279K W/380H P

DC12
11,7 ltr.
309K W/420H P

CR19

DT 12
11,7 ltr.
345K W/470H P

Page 1/2
Next page:
(syst.168001002)

Vertical
LHD/RHD
Standard

Front pipe

Silencer

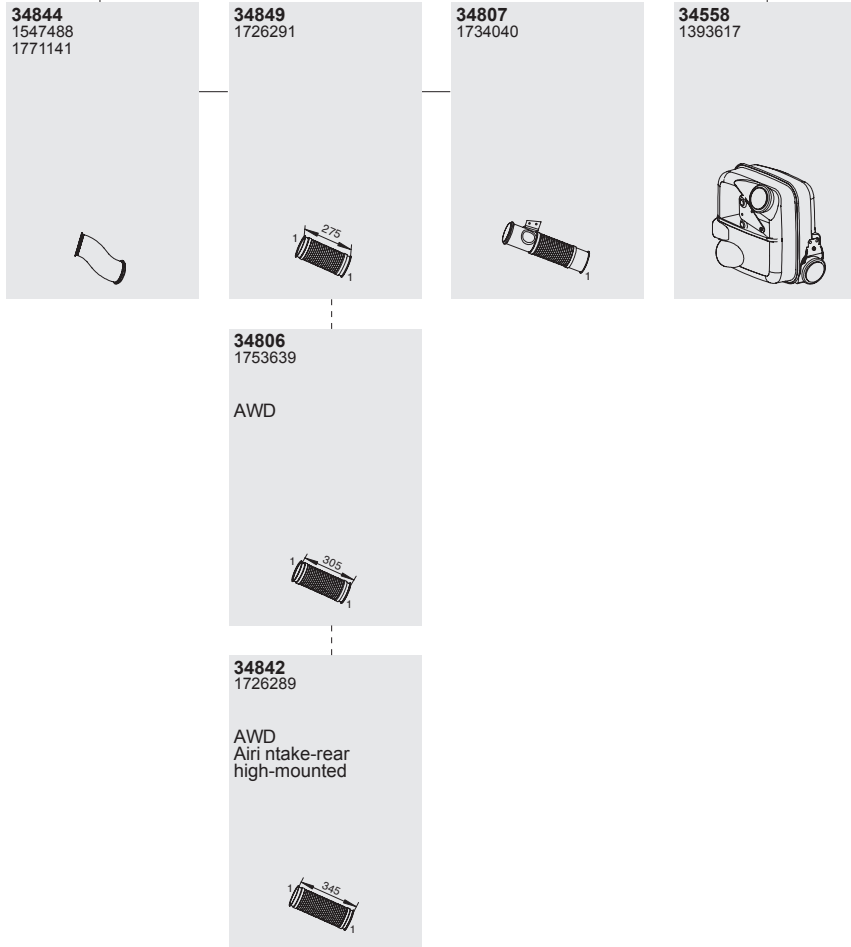

Mounting Parts

- 1. **34452**
1335618
1422474
1387136



Series P, R, T

Type

Euro III
03.2004 →

18/19/23,8t on.
26/32 ton.

④X②⑥X②/②
⑥X②/④⑥X④
⑥X②

CP14
CP19
CR19

☞ DC9
8,9l tr.
169K W/230H P
198K W/270H P
228K W/310H P

☞ DC11
10,6l tr.
250K W/340H P
279K W/380H P

☞ DC12
11,7 ltr.
309K W/420H P

CR19

☞ DT 12
11,7 ltr.
345K W/470H P

Page 2/2
Previous page
(syst.168001001)

Vertical
LHD/RHD
Standard

Silencer

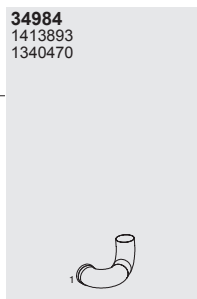
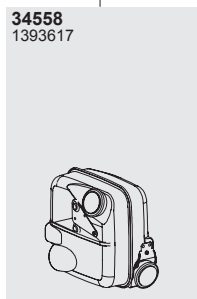

Mounting Parts

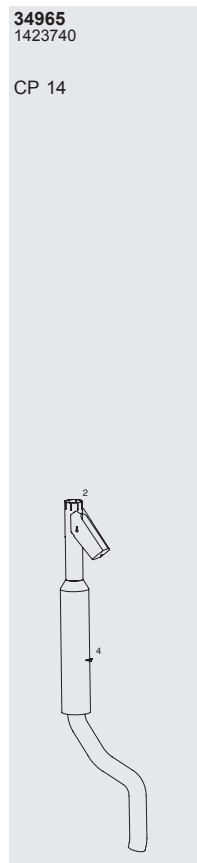
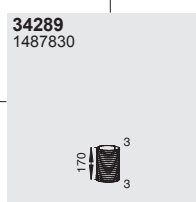
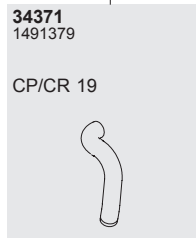
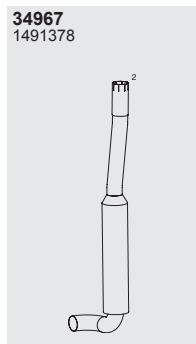
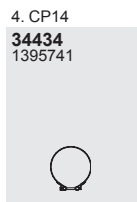
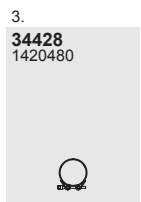
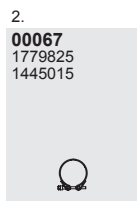

Tail pipe

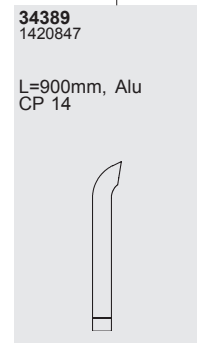
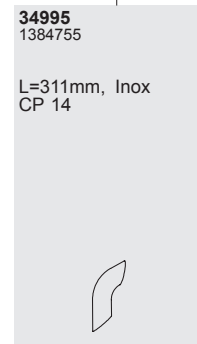
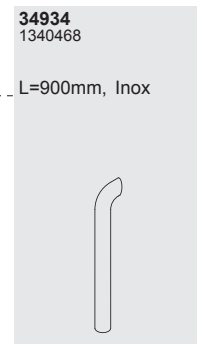
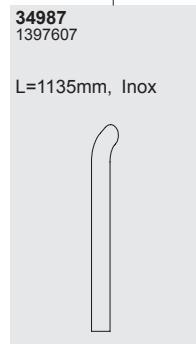
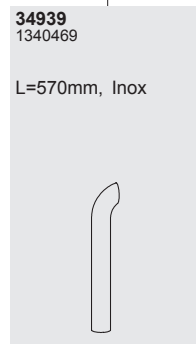

Series P, R, T

Type

Euro III
03.2004 →

18/19/23,8t on.
26/32 ton.

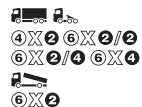

CP14
CP19
CR19

DC9
8,9l tr.
169K W/230H P
198K W/270H P
228K W/310H P

DC11
10,6l tr.
250K W/340H P
279K W/380H P

DC12
11,7 ltr.
309K W/420H P

CR19

DT 12
11,7 ltr.
345K W/470H P

Page 1/2
Next page:
(syst.168001004)

Vertical
LHD/RHD
Standard

Front pipe

Silencer

344759
1533946

DC9,DC11,DC12
AWD
1291877 SSS ▶CHno
3544688S LA ▶CHno
4500365 SNL ▶CHno
9083195 SAN ▶CHno



34699
1505749

DC9,DC11,DC12

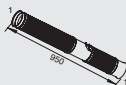

34849
1726291

DC9,DC11,DC12
AWD
Air intake rear,high mounted
1291877 SSS ▶CHno
3544688S LA ▶CHno
4500365 SNL ▶CHno
9083195 SAN ▶CHno



34695
1477000
1505748

DT12

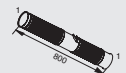

34849
1726291



34806
1753639



34807
1734040



34558
1393617



Mounting Parts

1.

34452
1335618
1422474
1387136



Series P, R, T

Type

Euro III
03.2004 →

18/19/23,8t on.
26/32 ton.

④X②⑥X②/②
⑥X②/④⑥X④
⑥X②

CP14
CP19
CR19

DC9
8,9l tr.
169K W/230H P
198K W/270H P
228K W/310H P

DC11
10,6l tr.
250K W/340H P
279K W/380H P

DC12
11,7 ltr.
309K W/420H P

CR19

DT 12
11,7 ltr.
345K W/470H P

Page 2/2
Previous page
(syst.168001003)

Vertical
LHD/RHD
Standard

Silencer

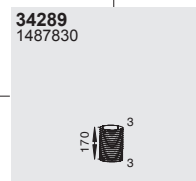
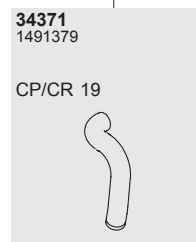
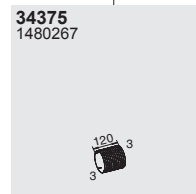
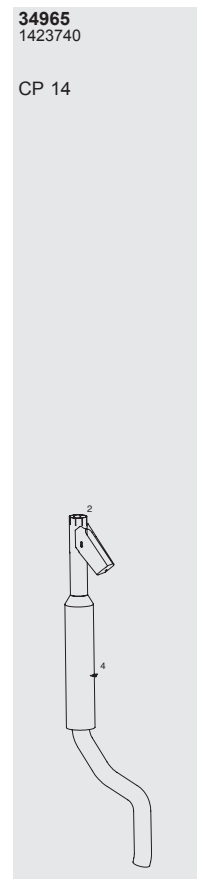
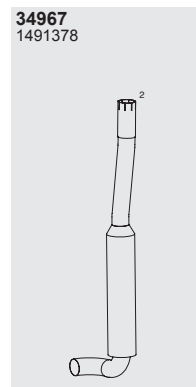
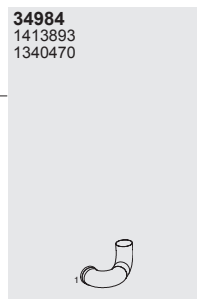
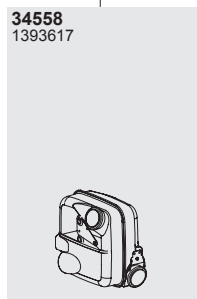

Mounting Parts

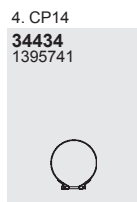
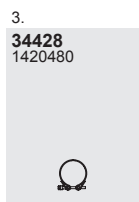
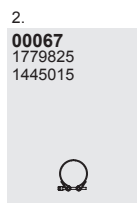

Tail pipe

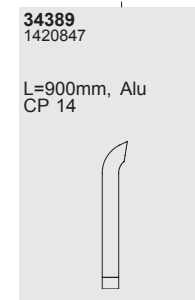
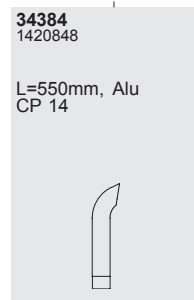
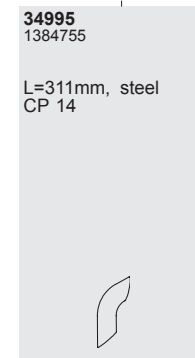
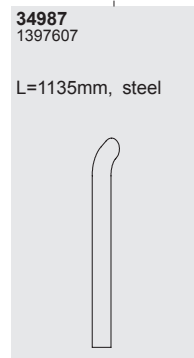
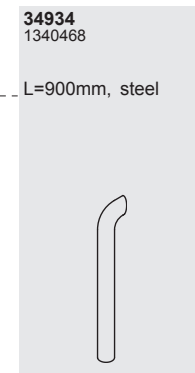

SOYLU / EURO I, II, III

VOLVO



FL C 334

FL 335

FM 356

FH 373

Series FL C

Type

Euro II
1996 →

 FL C

Front pipeT

46788
3953428
3952776
3953530



Silencer

48114
3950740

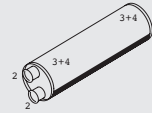

ail pipe

47324
3951375

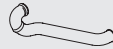

Mounting Parts

1.

48090
6779639



2.

48048
3950829



3.

48047
3952925



4.

48028
6850149
477130800
70305823



Horizontal
LHD
Standard

Series FL

Type

Euro III

FL6
 B265000 ▶CHno
 S921941 ▶CHno
 1921636 ▶CHno
 1921928
 2921849 ▶CHno
 2929187
 2921666 ▶CHno
 2921987

D6B
 138K W/180H P
 170K W/220H P
 192K W/250H P

Page 1/2
 Next page:
 (syst.180001015)

Vertical
 LHD/RHD
 Standard

Front pipe

Silencer

46794
20401991

mech. Air suspension front
E-Medium



46732
3953590

H-Medium

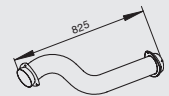

46733
3953591

E-Medium



48138
20386056

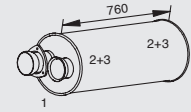

46799
20401990



46737
3953586

H-Medium
WB 2800, L-Medium

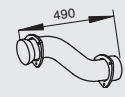

46736
3953587

H-Medium
L-Medium

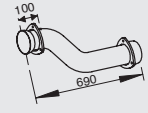

46731
3953589

E-Medium
mech.

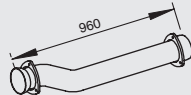

46735
3953588

H-Medium
mech.

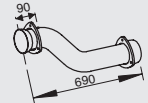

Mounting Parts

1.
48078
 3033054
 9522798



2.
47084
 20496601



3.
31481
 20496809



Series FL

Type

Euro III

FL6
 B265000 ▶CHno
 S921941 ▶CHno
 1921636 ▶CHno
 1921928
 2921849 ▶CHno
 2929187
 2921666 ▶CHno
 2921987

✎ D6B
 138K W/180H P
 170K W/220H P
 192K W/250H P

Page 2/2
 Previous page:
 (syst.180001014)

Vertical
 LHD/RHD
 Standard

Silencer

48138
20386056

47323
3951220

E-Medium
H-Medium

47329
3950039
20442228

47981
20350436

47987
3182098

47988
3182094

47326
3950136

47985
20350147

E-Medium
H-Medium

47986
3182099

Tail pipe

Mounting Parts

1.
48078
3033054
9522798

2.
47084
20496601

3.
41481
20496809

4.
00586
8151616
1079026
20871332

5.
00784
475499

6. x2
48099
977192
3123214

7.
08782
1071577
3122287
3123843

Series FL

Type

Euro III

FL6
 B265000 ▶CHno
 S921941 ▶CHno
 1921636 ▶CHno
 1921928
 2921849 ▶CHno
 2929187
 2921666 ▶CHno
 2921987

♻️ D6B
 138K W/180H P
 170K W/220H P
 192K W/250H P

Front pipe

46794
20401991

mech. Air suspension front
E-Medium



46732
3953590

H-Medium

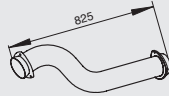

46733
3953591

E-Medium



46799
20401990

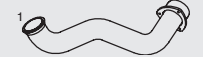

46737
3953586

H-Medium
WB 2800, L-Medium

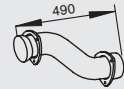

46736
3953587

H-Medium
L-Medium

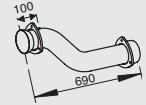

46731
3953589

E-Medium
mech.

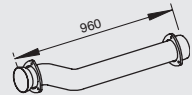

46735
3953588

H-Medium
mech.

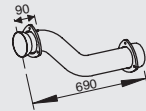

Silencer

48138
20386056

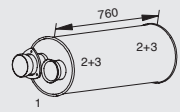

Tail pipe

48949
3121739

Right side



47982
20400170

Left side



Mounting Parts

1.
48078
3033054
9522798



2.
47084
20496601



3.
31481
20496809



Horizontal
LHD/RHD
Standard

Series FL

Type

Euro II
1996 →

B166080 ▶CHno
Bulti nB elgium

FL608
FL609
FL610
FL611

Horizontal
LHD
Standard

Front pipe

47696
3950038
3954416



46755
3172178
20442230
1070460



47691
3950360



L=940

47692
3950040



L=465

47693
3950257



WB 2800
L=402

Silencer

48119
8149232
3162349



Tail pipe

47361
3127360

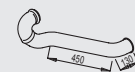

Incl.T railerV alve

47362
3126829



Excl.T railer Valve

Mounting Parts

1.
48078
3033054
9522798



2.
00586
8151616
1079026
20871332











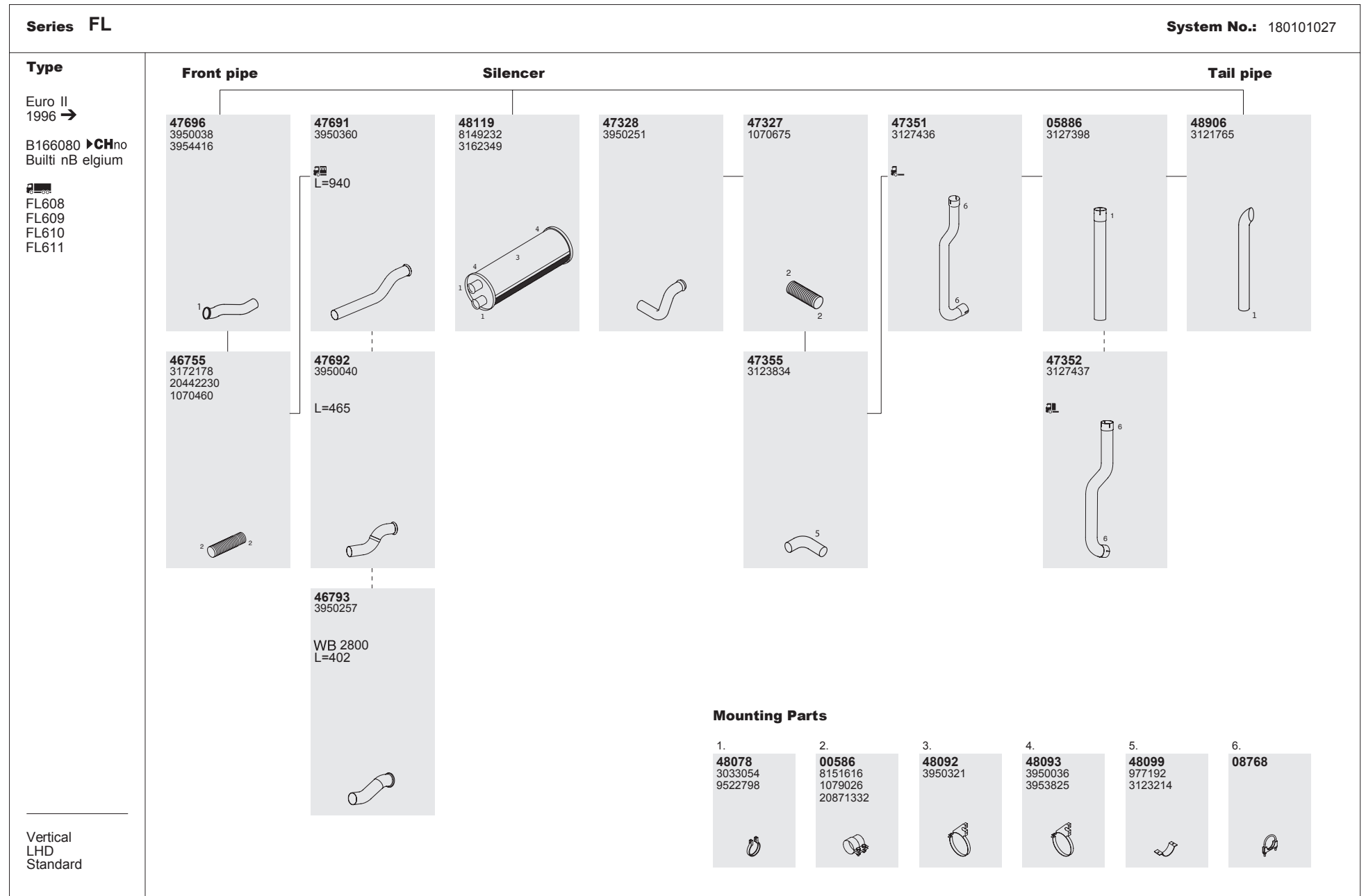







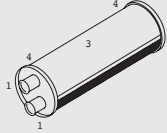
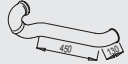









3.
48092
3950321



4.
48093
3950036
3953825





Series FL		Front pipe			Silencer		Tail pipe								
Type Euro II 1996 → B166080 ▶CHno Builti nB elgium  FL612 FL613 FL614 FL615	47696 3950038 3954416 FL612-614 ▶ AT545 WB 3000 L=569 		47655 3172178 20442230 1070460 		47641 3950134 FL615 L=431 		47649 3950256 FL612-614 WB 2600 L=353 		47647 3950513 FL612-614 ▶ MD3060P 5 L=892 		48119 8149232 3162349 		47361 3127360 Incl. Trailer valve 		
	47690 3950252 3954418 FL615, L=625 		47642 3950135 FL615, ▶ Aut. L=607 		47693 3950257 FL612-614 WB 2800 L=402 		47691 3950360 FL612-614  L=940 		47362 3126829 Excl. Trailer valve 						
	47694 3950624 3954417 FL612-614: ▶ MT643/MT653 WB 3000. FL615: ▶ Manual L=534 		47329 3950039 20442228 ▶ MT643/MT653 		47643 3950362 FL615, ▶ Aut.,  L=1082 		47692 3950040 FL612-614 ▶ AT545 L=465 		47645 3950361 FL612-614  ▶ MT643/MT653 L=1082 						
			46777 3950359 FL615,  L=906 		47646 3950042 FL612-614 ▶ MT643/MT653 L=606 		Mounting Parts 1. 48078 3033054 9522798 				2. 00586 8151616 1079026 20871332 		3. 48092 3950321 		4. 48093 3950036 3953825 
Horizontal LHD Standard															

Series FL

Type

Euro II
1996 →

B166080 ▶CHno
BUILT nB elgium

FL612
FL613
FL614
FL615

Page 1/2
Next page:
(syst. 180101040)

Vertical
LHD
Standard

Front pipe

47696
3950038
3954416

FL612-614
┌ AT545
WB 3000
L=569

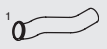

46755
3172178
20442230
1070460



47649
3950256

FL612-614
WB 2600
L=353



47646
3950042

FL612-614
┌ MT643/MT653
L=606



47645
3950361

FL612-614
┌ MT643/MT653
L=1082



46777
3950359

FL615
L=906



47690
3950252
3954418

FL615
L=625

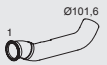

47329
3950039
20442228

┌ MT643/MT653



47693
3950257

FL612-614
WB 2800
L=402



47647
3950513

FL612-614
┌ MD3060P 5
L=892



47641
3950134

FL615
L=431



47643
3950362

FL615
┌ Aut.
L=1082



47694
3950624
3954417

FL612-614:
┌ MT643/MT653
WB 3000
FL615:
┌ Manual
L=534

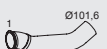

47329
3950039
20442228

┌ MT643/MT653



47692
3950040

FL612-614
┌ AT545
L=465



47691
3950360

FL612-614
L=940



47642
3950135

FL615
┌ Aut.
L=607



Silencer

48119
8149232
3162349

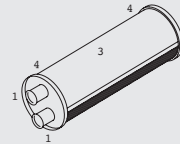

Mounting Parts

1.
48078
3033054
9522798



2.
00586
8151616
1079026
20871332



3.
48092
3950321



4.
48093
3950036
3953825



Series FL

Type

Euro II
1996 →

B166080 ▶CHno
Bulti nB elgium

FL612
FL613
FL614
FL615

Page 2/2
Previous page:
(syst. 180101028)

Silencer

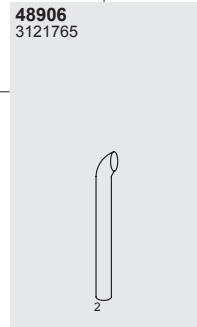
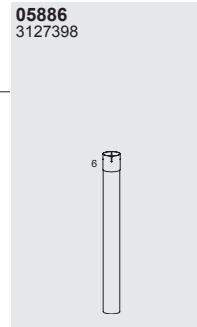
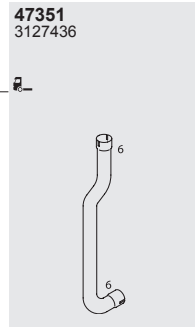
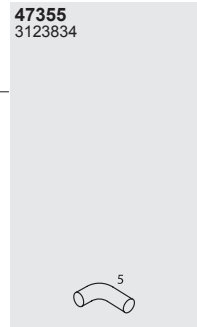
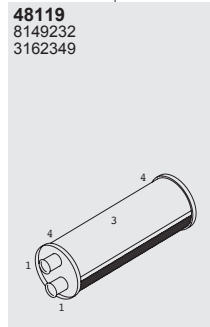

Tail pipe

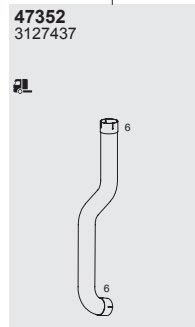
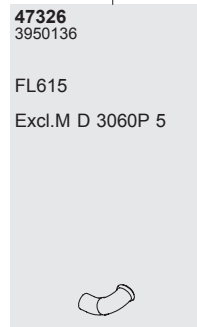

Mounting Parts

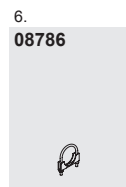
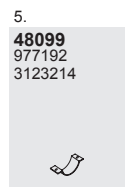
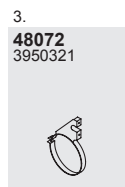
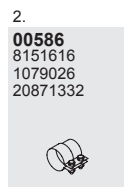
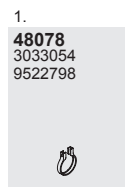

Vertical
LHD
Standard

Series FL

Type

Euro II
1996 →

B166080 ▶CHno
Bulti nB elgium

- FL616
- FL617
- FL618
- FL619
- FL620
- FL621
- FL622
- FL623
- FL624
- FL625
- FL626

Horizontal
LHD
Standard

Front pipe

47696
3950038
3954416
WB 3000
L=569



47694
3950624
3954417
Aut. front, WB 3400
manual, ④X②, ④X④



47690
3950252
3954418



47608
3950625
3954421
3181302
Air suspension front
L=798



47607
3951206
3954420
④X②, ④X④
manual



46755
3172178
20442230
1070460



47329
3950039
20442228
rear



47692
3950040
Air suspension rear
L=500



47604
3951227
Air suspension front
L=497



47600
3953428
WB 3000
L=372



47601
3950253
Air suspension front
L=798



47602
3951207
④X②, ④X④
Aut. L=631



47605
3950043
Aut., front
L=858



47606
3950041
L=781



47603
3951219
④X②, ④X④
manual WB 3400
Air suspension front
L=650



Silencer

48119
8149232
3162349



Tail pipe

47379
3124910



Mounting Parts

1.
48078
3033054
9522798



2.
00586
8151616
1079026
20871332



3.
48092
3950321



4.
48093
3950036
3953825



Series FL

Type

Euro II
1996 →

B166080 ▶CHno
Bulti nB elgium

- FL616
- FL617
- FL618
- FL619
- FL620
- FL621
- FL622
- FL623
- FL624
- FL625
- FL626

Page 1/2
Next page:
(syst. 180101042)

Vertical
LHD
Standard

Front pipe

47696
3950038
3954416

WB 3000
L=569



47329
3950039
20442228

rear



47604
3951227

front
L=497



47606
3950041

L=781



47694
3950624
3954417

④ X ②, Aut.
front, WB 3400
manual, ⑥ X ②, ⑥ X ④



46755
3172178
20442230
1070460



47692
3950040

rear
L=500



47601
3950253

front
L=798



47690
3950252
3954418



47602
3951207

⑥ X ②, ⑥ X ④
Aut.
L=631



47605
3950043

Aut., front
L=858



47608
3950625
3954421
3181302

front
L=798



47603
3951219

⑥ X ②, ⑥ X ④, manual, WB 3400
④ X ②, front
L=650



47607
3951206
3954420

⑥ X ②, ⑥ X ④
manual



Silencer

48119
8149232
3162349

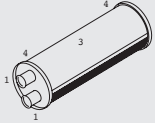

Mounting Parts

1.
48078
3033054
9522798



2.
00586
8151616
1079026
20871332



3.
48092
3950321



4.
48093
3950036
3953825



Series FL

Type

Euro II
1996 →

B166080 ▶CHno
Bulti nB elgium

- FL616
- FL617
- FL618
- FL619
- FL620
- FL621
- FL622
- FL623
- FL624
- FL625
- FL626

Page 1/2
Next page:
(syst. 180101042)

Vertical
LHD
Standard

Front pipe

47696
3950038
3954416

WB 3000
L=569



47329
3950039
20442228

rear



47604
3951227

front
L=497



47606
3950041

L=781



47694
3950624
3954417

4X2, Aut.
front, WB 3400
manual, 4X2, 4X4



46755
3172178
20442230
1070460



47692
3950040

rear
L=500



47601
3950253

front
L=798



47690
3950252
3954418



47602
3951207

6X2, 6X4
Aut.
L=631



47605
3950043

Aut.
L=858
front



47608
3950625
3954421
3181302

front
L=798



47603
3951219

6X2, 6X4, manual, WB 3400
4X2, front
L=650



47607
3951206
3954420

6X2, 6X4
manual



Silencer

48119
8149232
3162349

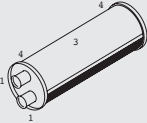

Mounting Parts

1.
48078
3033054
9522798



2.
00586
8151616
1079026
20871332



3.
48092
3950321



4.
48093
3950036
3953825



Series FL

Type

Euro II
1996 →

B166080 ▶CHno
Builti nB elgium

- FL616
- FL617
- FL618
- FL619
- FL620
- FL621
- FL622
- FL623
- FL624
- FL625
- FL626

Page 2/2
Previous page:
(syst. 180101032)

Vertical
LHD
Standard

Silencer

Tail pipe

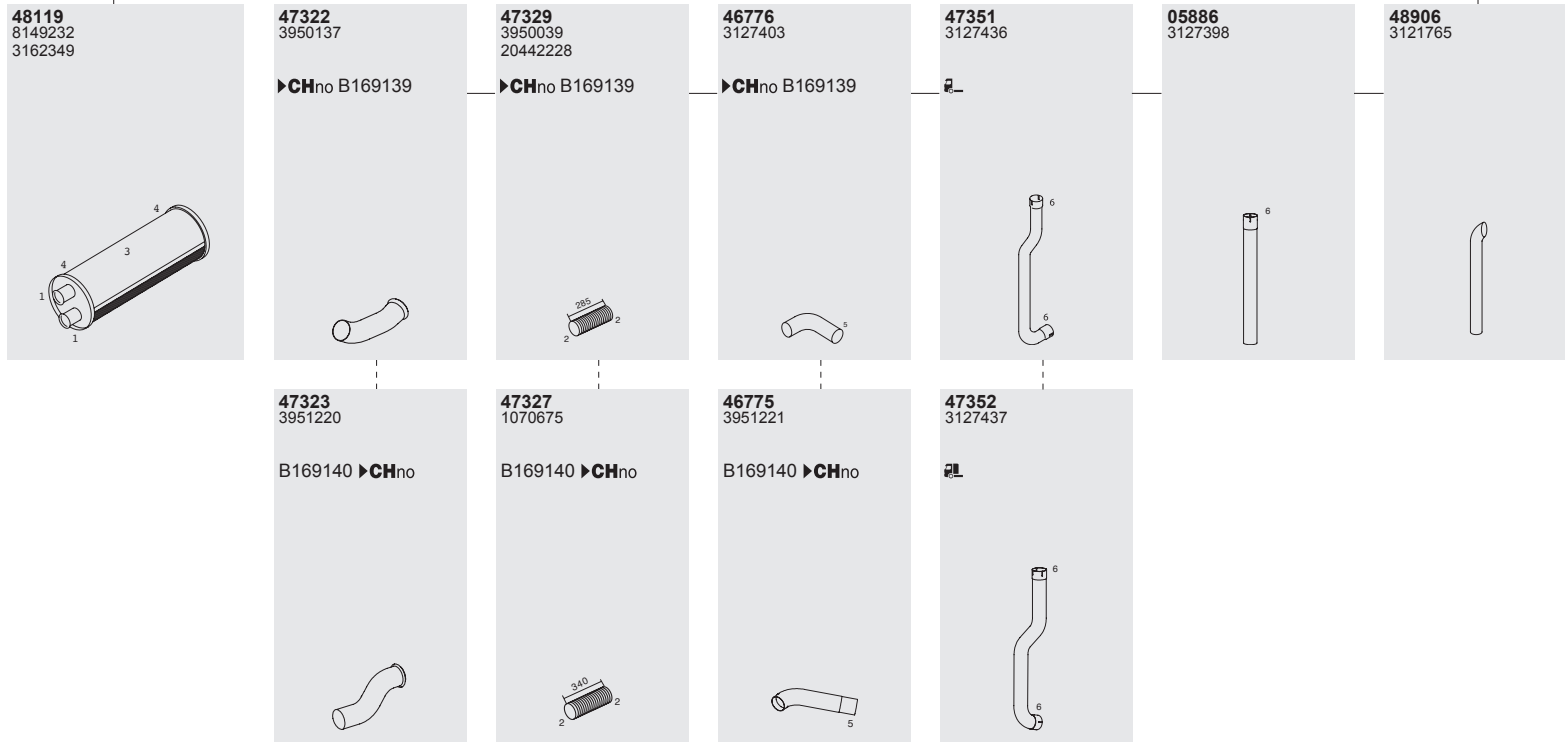

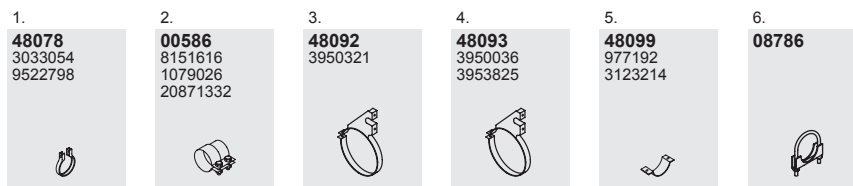

Mounting Parts



Series FL

Type

Euro II

  
 TD71 engine
 TD73 engine

FL7

Front pipe

48638
1625710
TD71



48729
1608108
1588638
20422024



Ø90 L=398

48620
1613283



47701
1624998



Ø90 L=375

47705
1625708



47702
81556718
8156718
TD73



48757
1586825
1609345



Ø115 L=400mm

48637
1624915
8151632



47707
8152560
1078119
20442239



Ø115 L=316mm

Silencer

48512
11665618
1665618
1544915
TD71

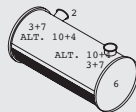

48300
1083721
TD71



48303
1078123
1614285
8152566



Ø115 L=270mm

48591
1614275
1674004
1676640
TD71, T D73

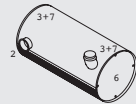

48314
1608460
3963334
TD71, T D73



47661
8152558
1608080
22442237



Ø115 L=320mm

48304
8151633
1624916



48337
1607521



L=1035

48332
1607522



L=535

Mounting Parts

1.
48082
1624613
471355



2.
48414
508850
1624612
9522768



3.
48403
1594782
1608387



4.
48039
3963378



5.
00768
1589141



6.
48402
1605164
3943974
20409127



6. Inox
48053
1588971



7.
48024
1594267
8157516



8.
00803
1193870



9.
48054
1607616



10.
48033
3963371





Vertical
LHD
Standard

Series FL

Type

Euro II

 
 TD71 engine
 TD73 engine

FL7

Front pipe

Silencer

Tail pipe

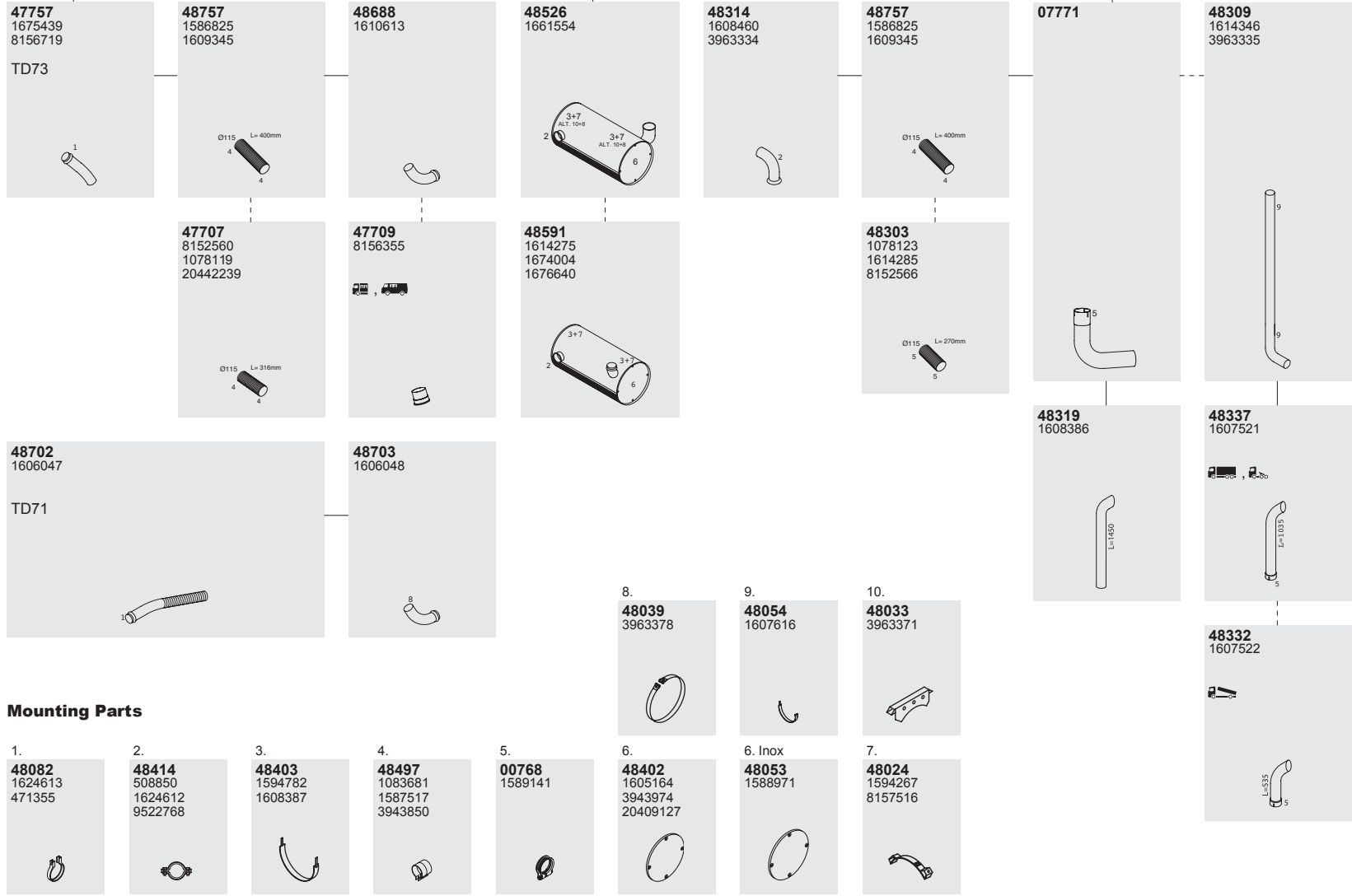







Vertical
 LHD
 Standard

Series FL

Type

Euro II

-   
-  
-  
- TD73 engine

FL7

Front pipe

47710
1675569
8152589
8156720



47728
1675498

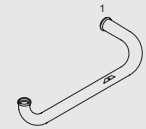

47721
1675564
8156715



47703
8152562
1078120
20442238



47726
1675565



47725
1675571
1078118
20442241



Silencer

48527
1661420



48020
1605600



Tail pipe

48313
1608385



48319
1608386



Mounting Parts

1.
48414
508850
1624612
9522768



2.
00768
1589141



3.
48497
1083681
1587517
3943850



4.
08768
1581047
1581046



5.
48038
1608389



Vertical
LHD
Standard

Series FL

Type

Euro II



FL10

Front pipe

48618
1080018



48757
1586825
1609345



48617
1080198
8154091

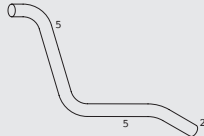

48616
470696
1078127



48615
1626377



Silencer

48512
11665618
1665618
1544915

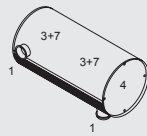

Tail pipe

48353
1609192



47707
8152560
1078119
20442239



47312
8159336



Mounting Parts

1.
48414
508850
1624612
9522768



2.
48497
1083681
1587517
3943850



3.
48403
1594782
1608387



4.
48402
1605164
3943974
20409127



4. Inox
48053
1588971



5.
08768
1581047
1581046



6.
00768
1589141



7.
48024
1594267
8157516



8.
48042
3943785



9.
48049
8159337



10.
48041
3943364





Horizontal
LHD
Standard

Series FL

Type

Euro II

 
 TD101 engine
 ▶CHno338170

FL10

Front pipe

48683
1607603
1626143



48684
1605629
8152590



48689
1605454

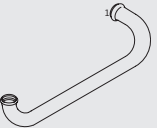

48680
1605632
1626144



Silencer

48527
1661420









48020
1605600



Tail pipe

48319
1608386

 , E xcl.  ,  ,  , 



48313
1608385



Mounting Parts

1.
48414
508850
1624612
9522768



2.
00768
1589141



3.
08768
1581047
1581046



4.
48038
1608389



Vertical
LHD
Standard

Series FL

Type

Euro II



FL10



FL12

Front pipe

47632
3943615



47755
8156350
1078110
3199065



47631
3943616



Silencer

48112
8149900

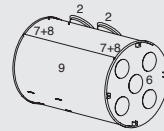

47314
1678532



47755
8156350
1078110
3199065



47310
1678519



Tail pipe

47374
8157498



Mounting Parts

1.
00569



2.
48067
1629499



3.
00752
1674248



4.
48030
1607294



5.
04169
8081852
21042291



6.
48402
1605164
3943974
20409127



6. Inox
48053
1588971



7.
48033
3963371



8.
48039
3963378















9.
48097
1678604

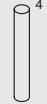

10.
48068
1638168



Vertical
LHD
Standard

Series FL						
Type	Front pipe		Silencer		Tail pipe	
Euro II						
 D12A engine						
FL12						
	47685 8157499 8157953 	47755 8156350 1078110 3199065 	47681 8157501 	48171 1665198 	48020 1605600 	47374 8157498 
	Mounting Parts					
	1. 48068 1638168 	2. 48067 1629499 	3. 00564 20455908 8156156 	4. 04169 8081852 21042291 	5. 00358 20743152 	6. 48038 1608389 
Vertical LHD Standard						

Series FL

Type

Euro II/III



D12A engine

FL12

Front pipe

47700
8157449



47755
8156350
1078110
3199065



47688
8157450



Silencer

48187
1676496
3979909
3979599
TUV/KBA 21206



48939
1629054



48934
8147410
8156351
20442244



48997
8147305



Tail pipe

48186
1676499

Euro II/III
TUV/ KAB 21207

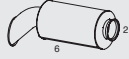

47974
3183953

Euro III



47966
20564260

Euro IV/V



Mounting Parts

1.
48068
1638168



2.
48067
1629499



3.
00564
20455908
8156156



4.
48024
1594267
8157516



5.
48403
1594782
1608387



6.
48061
1629345
1628246
20743127



7.
48402
1605164
3943974
20409127



7. Inox
48053
1588971



8.
48069
1629067



Horizontal
LHD
Standard

Series FL

Type

Euro II/III



D12A engine

FL12

Front pipe

47687
8157493

47755
8156350
1078110
3199065

47751
1626097

Silencer

48187
1676496
3979909
3979599
TUV/KBA 21206

48268
8157494

48934
8147410
8156351
20442244

48266
3943609

Tail pipe

48186
1676499

Euro II/III
TUV/KBA 21207

47974
3183953

Euro III

47966
20564260

Euro IV/V

47686
8157491

48934
8147410
8156351
20442244

Mounting Parts

1.
48068
1638168

2.
48067
1629499

3.
00564
20455908
8156156

4.
48024
1594267
8157516

5.
48403
1594782
1608387

6.
48061
1629345
1628246
20743127

7.
48402
1605164
3943974
20409127

7. Inox
48053
1588971

8.
48058
1674585

Horizontal
LHD
Standard

Series FM

Type

Euro II/III



FM7
FM10

PTOFLY
With power take off, flywheel housing.

UPTOFLY
Without power take off n flywheel housing.

NR-BASIC
Sound level, basic requirements.

NR-80EC
Sound level 80dB.

Horizontal
LHD
Standard

Front pipe

46752
3171352
20442226



46764
1076136



46718
3199065



47751
1626097



Silencer

48187
1676496
3979909
3979599
TUV/KBA 21206

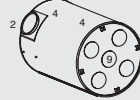

48933
1628883



48939
1629054



Low chassis
=810 mm.

48934
8147410
8156351
20442244



48998
1628052
20429020
20535530
NR-BASIC
PTOFLY



48996
1629057

NR-BASIC
UPTOF



47615
1629055

NR-80EC
UPTOF



48997
8147305

NR-80EC
PTOFLY



Tail pipe

48186
1676499
Euro II/III
TUV/KBA 21207

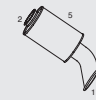

47974
3183953

Euro III



47966
20564260

Euro IV/V



Mounting Parts

1.
48044
8156575



2.
48067
1629499



3.
00564
20455908
8156156



4.
48065
1623933
20510284



5.
48061
1629345
1628246
20743127



6.
48069
1629067



7.
00586
8151616
1079026
20871332



8.
00085
1076493



9.
48402
1605164
3943974
20409127



9. Inox
48053
1588971



Series FM

Type

Euro II/III



FM12

PTOFLY
With power take off, flywheel housing.

UPTOFLY
Without power take off on flywheel housing.

NR-BASIC
Sound level, basic requirement.

NR-80EC
Sound level 80dB.

Front pipe

47756
1629939



46718
3199065



47751
1626097



Silencer

48187
1676496
3979909
3979599
Euro II/III
TUV/KBA 21206

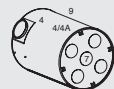

48933
1628883



48939
1629054

Low chassis
=810 mm.



48434
8147410
8156351
20442244



48998
1628052
20429020
20535530
NR-BASIC
PTOFLY



48996
1629057



Tail pipe

48186
1676499



Euro II/III
TUV/KBA 21207

47974
3183953



Euro III

47615
1629055

NR-80EC
UPTOFLY



47966
20564260

Euro IV/V



48997
8147305

NR-80EC
PTOFLY



Mounting Parts

1.
48068
1638168



2.
48067
1629499



3.
00564
20455908
8158156



4.
48065
1623933
20510284



4A.
48018
20506176



5.
48061
1629345
1628246
20743127



6.
48069
1629067



7.
48402
1605164
3943974
20409127



7. Inox
48053
1588971



8.
48044
8156575



9.
31407
20443247



Horizontal
LHD
Standard

Series FM

Type

Euro II

 Rear outlet

FM7
FM10

Horizontal
LHD
Standard

Front pipe

46752
3171352
20442226



46764
1076136



46756
1078456

⊗X 2 , ⊗X 4



46718
3199065



47751
1626097



Silencer

48187
1676496
3979909
3979599

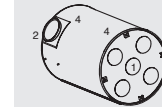

47337
3962786

⊗X 2
Air suspension rear
6a irbellows



47347
3988977

⊗X 2
Air suspension rear
⊗X 2 , rear



48182
1675864

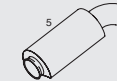

48995
1625965
8190133



47346
20374312

4X 4 , 6X 6 , 8X 8



47336
8159458

4X 2
Air suspension rear
⊗X 2 ⊗X 2
rear



Mounting Parts

1.
48402
1605164
3943974
20409127



1. Inox
48053
1588971



2.
48067
1629499



3.
00564
20455908
8156156



4.
48065
1623933
20510284



5.
48062
1629345



6.
00586
8151616
1079026
20871332



7.
00085
1076493



Series FM

Type

Euro II

 
Rear outlet

FM12

Front pipe

Silencer

Tail pipe

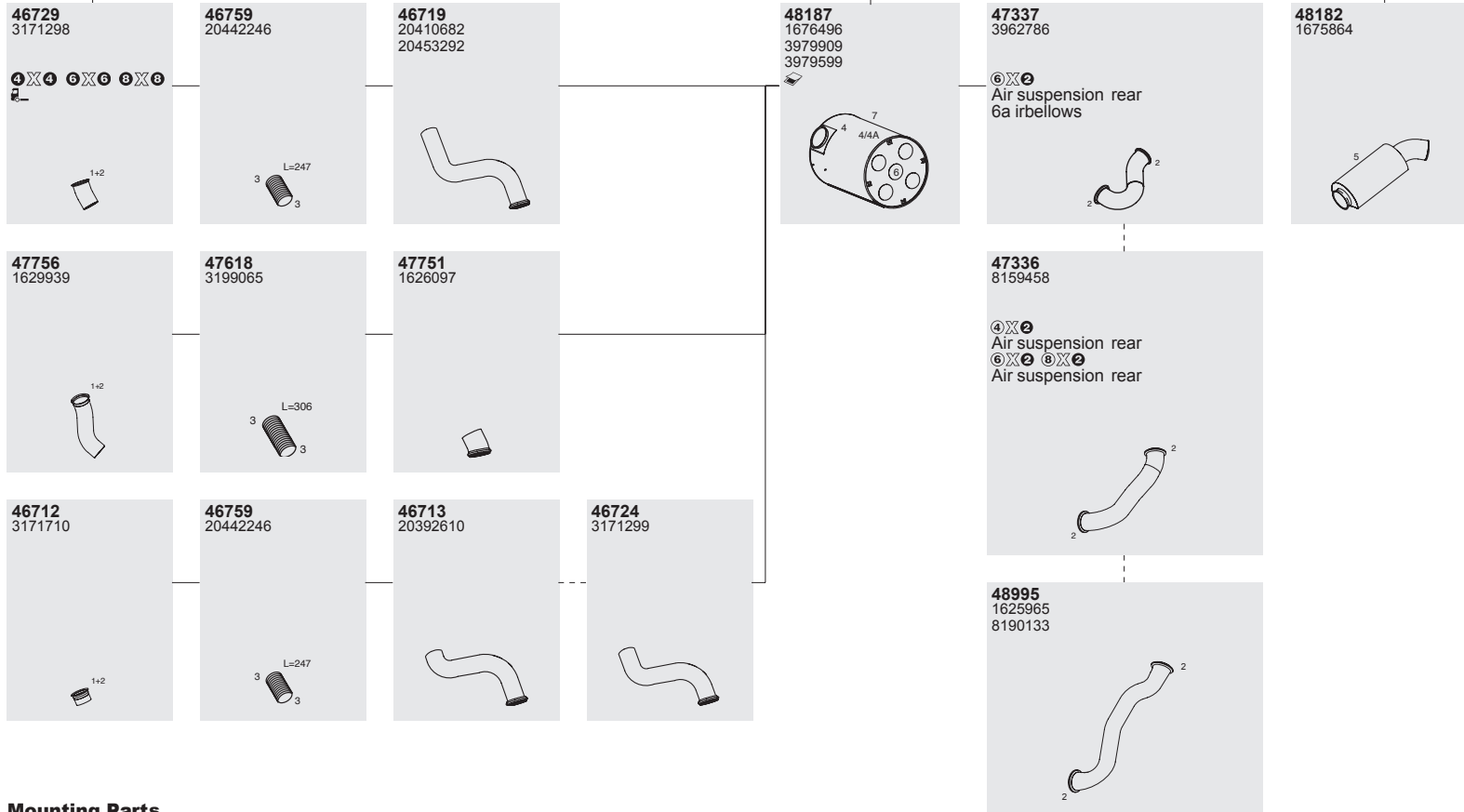

Mounting Parts

- | | | | | | | | | |
|-------------------------------|-------------------------------|---|---|---------------------------------|-------------------------------|--|------------------------------------|--------------------------------|
| 1.
48068
1638168 | 2.
48067
1629499 | 3.
00564
20455908
8156156 | 4.
48065
1623933
20510284 | 4A.
48018
20506176 | 5.
48062
1629345 | 6.
48402
1605164
3943974
20409127 | 6. Inox
48053
1588971 | 7.
35407
20443247 |
|-------------------------------|-------------------------------|---|---|---------------------------------|-------------------------------|--|------------------------------------|--------------------------------|

Horizontal
LHD
Standard

Series FM

Type

Euro II/III



FM7
FM10
FM12

Page 1/2
Next page:
(syst. 180100068)

Front pipe

47753
1088969
8157257

46752
3171352
20442226

46756
1078456

46718
3199065

FM12

47343
20428993

A544696 ▶CHno
B311774 ▶CHno

Silencer

48185
8157258
8151798
8149655

48990
8154822

47759
8184513
8154893
8156660
FM12

46718
3199065

FM12

47753
1088969
8157257

Mounting Parts

1.
48068
1638168

2.
48067
1629499

3.
00564
20455908
8156156

4.
48063
1088995

5.
00085
1076493

6.
48069
1629067

7.
48402
1605164
3943974
20409127

7. Inox
48053
1588971

8.
48060
1075184

9.
48094
3962698
20367256

10.
00586
8151616
1079026
20871332

Horizontal
LHD
Standard

Series FM

Type

Euro II/III



FM7
FM10
FM12

Page 2/2
Previous page:
(syst. 180100062)

Silencer

48185
8157258
8151798
8149655

47753
1088969
8157257

48934
8147410
8156351
20442244

48990
8154822

Tail pipe

48186
1676499

Euro II/III
TUV/KBA 21207

47974
3183953

Euro III

47966
20564260

Euro IV/V

47343
20428993

A544696 ▶CHno
B311774 ▶CHno

48126
3944237

Rear outlet

47399
3944238

Rear outlet

Mounting Parts

1.
48044
8156575

2.
48067
1629499

3.
00564
20455908
8156156

4.
48063
1088995

5.
48061
1629345
1628246
20743127

6.
48069
1629067

7.
48402
1605164
3943974
20409127

7. Inox
48053
1588971

8.
48094
3962698
20367256

Horizontal
LHD
Standard

Series FM

Type

Euro II

 FM7
FM10

Front pipe

46752
3171352
20442226



46764
1076136



46718
3199065



47751
1626097



Silencer

48181
1676497
20431610

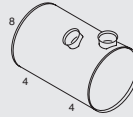

48948
1626484



46718
3199065



48946
1626488



48945
1628493
1629738



Mounting Parts

1.
00085
1076493



2.
48067
1629499



3.
00564
20455908
8156156



4.
48065
1623933
20510284



5.
00752
1674248



6.
48064
1628993
1629056



7.
00586
8151616
1079026
20871332



8.
48402
1605164
3943974
20409127



8. Inox
48053
1588971



9.
04169
8081852
21042291



Vertical
LHD
Standard









Series FM

Type



Euro II

 FM12



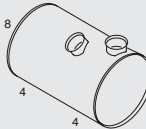

Front pipe

<p>47756 1629939</p> 	<p>46718 3199065</p> 	<p>47751 1626097</p> 
<p>46729 3171298</p> <p>4 X 4 6 X 6 8 X 8</p> 	<p>46759 20442246</p> <p>L=247</p> 	<p>46724 3171299</p> <p>4 X 4 6 X 6 8 X 8</p> 
<p>46712 3171710</p> <p>4 X 4 6 X 6 8 X 8</p> 	<p>46713 20392610</p> <p>4 X 4 6 X 6 8 X 8</p> 	









Silencer

<p>48181 1676497 20431610</p> 	<p>48948 1626484</p> 
	<p>47305 3987968</p> <p>4 X 4 6 X 6 8 X 8</p> 

Tail pipe

<p>48946 1626488</p> 	<p>47302 20367402</p> <p>4 X 4 6 X 6 8 X 8</p> 
<p>47301 3171288</p> <p>4 X 4 6 X 6 8 X 8</p> 	<p>48945 1628493 1629738</p> 

Mounting Parts

<p>1. 48068 1638168</p> 	<p>2. 48067 1629499</p> 	<p>3. 00564 20455908 8156156</p> 	<p>4. 48065 1623933 20510284</p> 	<p>5. 00752 1674248</p> 	<p>6. 48064 1628993 1629056</p> 	<p>8. 48402 1605164 3943974 20409127</p> 	<p>8. Inox 48053 1588971</p> 	<p>9. 04169 8081852 21042291</p> 
--	--	---	---	---	--	---	---	---

Vertical
LHD
Standard

Series FM

System No.: 180101034

Type

Euro II

 FM7
FM10

Front pipe

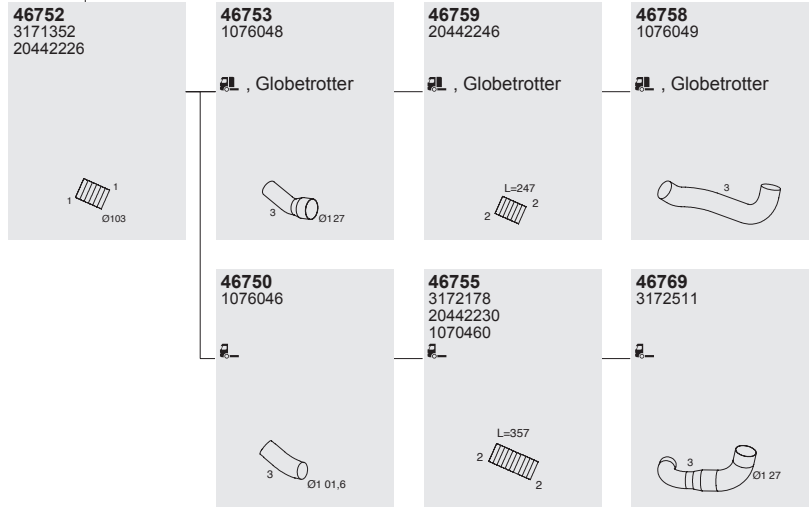

Silencer

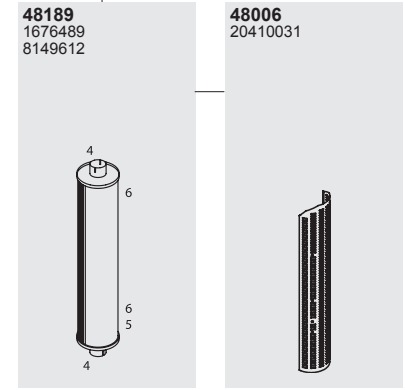

Tail pipe

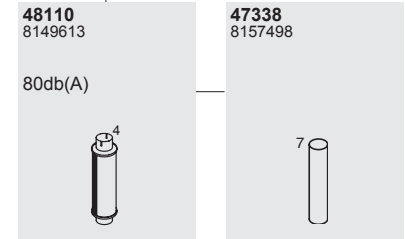

Mounting Parts

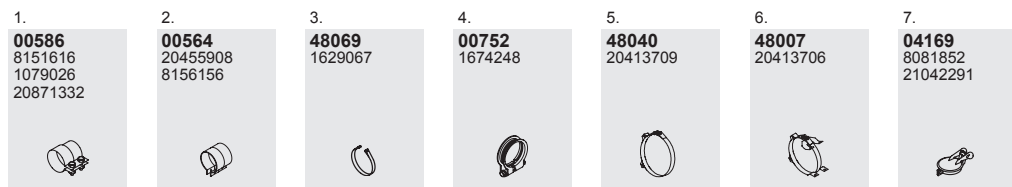

Vertical
LHD
Standard

Series FM

Type

Euro III



☞ D9A6 cyl.
9,4l tr.
191K W/260H P
221K W/300H P
250K W/340H P
279K W/380H P

☞ D12D 6 cyl.
12,1l tr.
250K W/340H P
279K W/379H P
309K W/420H P
338K W/460H P

☞ D13A 6 cyl.
294K W/400H P
324K W/440H P
353K W/480H P
382K W/520H P

FAA 10-one
non-driven front
axle
FAA 20-two
non-driven front
axle

EXHP-SAC
Aluminized
coated steel
exh.pipe

EXHP-SCP
Painted carbon
steel exh.pipe

PTOFLY With
power take off,
flywheel housing

UPTOFLY
Without power
take off on
flywheel housing

Horizontal
LHD
Standard

Front pipe

47756
1629939

EXHP-SAC
FAA1 0
FAA2 0 ☞ D9A,
D13A

46718
3199065

47751
1626097

EXHP-SAC

48187
1676496
3979909
3979599

☞ D9A,D13A

48939
1629054

48934
8147410
8156351
20442244

48998
1628052
20429020
20535530
FAA10
UPTOFLY,EXHP-SAC
FAA20U PTOFLY

47974
3183953

Without aerodynamic
device

46705
20409095

TURBO-C
FAA1 0

46700
20535469

EXHP-SCP
FAA1 0

48185
8157258
8151798
8149655
FAA2 0

47964
20974489

47970
3943722

PTOFLY

47966
20564260

Aerodynamic device
extended chassis
fairing

46709
20506999

FAA1 0

Mounting Parts

1.
48068
1638168

2.
48067
1629499

3.
00564
20455908
8156156















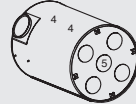

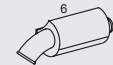

4.
48065
1623933
20510284















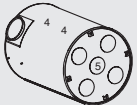

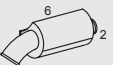

5.
48402
1605164
3943974
20409127

6. FAA2 0
48063
1088995

7.
48069
1629067

8.
48061
1629345
1628246
20743127

Series FM									
Type	Front pipe			Silencer	Tail pipe				
Euro III FAA1 0  D9A6 cyl. 191K W/260H P 221K W/300H P 250K W/340H P 280K W/380H P D12D 6 cyl. 250K W/340H P 279K W/379H P 309K W/420H P 338K W/460H P D13A 6 cyl. 294K W/400H P 324K W/440H P 353K W/480H P 382K W/520H P REAR OUTLET FAA 10-one non-driven front axle EXHP-SAC Aluminized coated steel exh.pipe EXHP-SCP Painted carbon steel exh.pipe PTOTRA-S Single power take off transmission PA-FIXED Fixed pusher axle FUELTS71 Fuel tank semi rectangular for diam.71b rackets BBOX-RB attery box rights ide	47756 1629939 			46718 3199065 	47751 1626097 EXHP-SAC 	48187 1676496 3979909 3979599 	47979 20443348 FUELTS5 6 PTOTRA-D/PTOTRA-S 	47969 20745251 FUELTS7 1 UPTOTRA 	48182 1675864 
	46705 20409095 D12A TURBO-C 	46700 20535469 EXHP-SCP 			47336 8159458 FUELTS7 1 PTOTRA-D/PTOTRA-S 	47337 3962786 D9A, D13A PA-FIXED, BBOX-R 			
	Mounting Parts								
	1. 48068 1638168 	2. 48067 1629499 	3. 00564 20455908 8156156 	4. 48065 1623933 20510284 	5. 48402 1605164 3943974 20409127 	5. Inox 48053 1588971 	6. 48061 1629345 1628246 20743127 		
Horizontal LHD/RHD Standard									

Series FM	Front pipe			Silencer		Tail pipe	
<p>Type</p> <p>Euro III</p> <p>FAA1 0</p>  <p>D9A6 cyl. 191K W/260H P 221K W/300H P 250K W/340H P 280K W/380H P</p> <p>D12D 6 cyl. 250K W/340H P 279K W/379H P 309K W/420H P 338K W/460H P</p> <p>D13A 6 cyl. 294K W/400H P 324K W/440H P 353K W/480H P 382K W/520H P</p> <p>REAR OUTLET FAA 10-one non-driven front axle EXHP-SAC Aluminized coated steel exh.pipe EXHP-SCP Painted carbon steel exh.pipe PTOTRA-S Single power take off transmission PA-FIXED Fixed pusher axle FUELTS71 Fuel tank semi rectangular for diam.71b rackets BBOX-RB attery box rights ide</p> <p>Horizontal LHD/RHD Standard</p>	<p>47756 1629939</p> 	<p>46718 3199065</p> 	<p>47751 1626097</p> <p>EXHP-SAC</p> 	<p>48187 1676496 3979909 3979599</p> 	<p>47979 20443348</p> <p>FUELTS5 6 PTOTRA-D/PTOTRA-S</p> 	<p>47969 20745251</p> <p>FUELTS7 1 UPTOTRA</p> 	<p>48182 1675864</p> 
	<p>46705 20409095</p> <p>D12A TURBO-C</p> 		<p>46700 20535469</p> <p>EXHP-SCP</p> 		<p>47336 8159458</p> <p>FUELTS7 1 PTOTRA-D/PTOTRA-S</p> 	<p>47337 3962786</p> <p>D9A, D13A PA-FIXED, BBOX-R</p> 	
	Mounting Parts						
	<p>1. 48068 1638168</p> 	<p>2. 48067 1629499</p> 	<p>3. 00564 20455908 8156156</p> 	<p>4. 48065 1623933 20510284</p> 	<p>5. 48402 1605164 3943974 20409127</p> 	<p>5. Inox 48053 1588971</p> 	<p>6. 48061 1629345 1628246 20743127</p> 

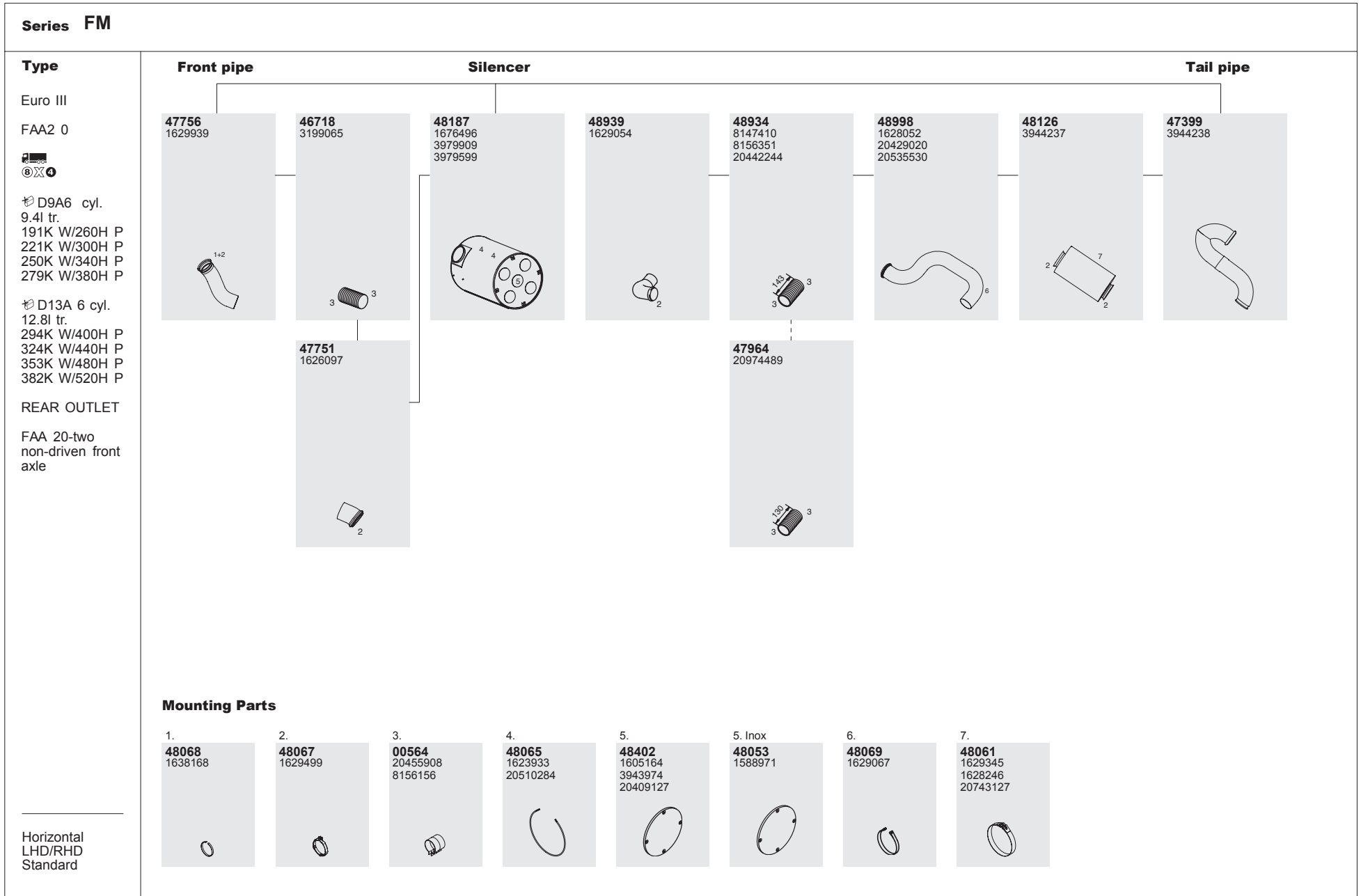

Series FM

Type

Euro III

FM9
12/01 → 09/05

☞ D9A6 cyl.
9,4l tr.
191K W/260H P
221K W/300H P
250K W/340H P
279K W/380H P

18 ton
26 ton



FM12
08/98 → 09/05

☞ D12D 6 cyl.
12,1l tr.
250K W/340H P
279K W/380H P
309K W/420H P

18 ton
25 ton
26 ton
32 ton



Vertical
LHD/RHD
Standard

Front pipe

Silencer

Tail pipe

Front pipe	Silencer	Tail pipe
<p>46711 20409103</p> <p>☞ G lobetrotter, GlobetrotterX L</p>	<p>47755 8156350 1078110 3199065</p>	<p>46715 20409099</p>
<p>46717 20367760</p>	<p>47755 8156350 1078110 3199065</p>	<p>46716 20367761</p>
	<p>48121 3979912 20580850</p>	<p>47348 3987052 3987053</p>
	<p>48122 3183697 20582423</p>	<p>47338 8157498</p>

Mounting Parts

<p>1. 48068 1638168</p>	<p>2. 48067 1629499</p>	<p>3. 00564 20455908 8156156</p>
<p>4. 48485 3987072</p>	<p>5. 00358 20743152</p>	<p>6. 04169 8081852 21042291</p>

Series FM

Type

Euro III
09/2000 →

18 ton



☉ D9B6 cyl.
9,4l tr.
221K W/300H P
250K W/340H P
280K W/380H P

☉ D13A 6 cyl.
12,8l tr.
264K W/360H P
294K W/400H P
324K W/440H P
353K W/480H P

☉ D13B 6 cyl.
12,8l tr.
368K W/500H P

Front pipe

Silencer

Tail pipe

46711
20409103

☉ G lobetrotter,
GlobetrotterX L

47755
8156350
1078110
3199065

46715
20409099

48121
3979912
20580850

47348
3987052
3987053

46717
20367760

47755
8156350
1078110
3199065

46716
20367761

48122
3183697
20582423

47338
8157498

Mounting Parts

1.
48068
1638168

2.
48067
1629499

3.
00564
20455908
8156156

4.
48485
3987072

5.
00358
20743152

6.
04169
8081852
21042291

Vertical
LHD/RHD
Standard

Series FM

Type

Euro II

FM7
08/98 → 12/01

∅ D7C6 cyl.
7,3l tr.
184K W/250H P
213K W/290H P

18 ton
25 ton
26 ton



FM10
09/98 → 12/01

∅ D10B 6 cyl.
9,6l tr.
235K W/320H P
265K W/360H P

18 ton
26 ton



Vertical
LHD/RHD
Standard

Front pipe

Silencer

Tail pipe

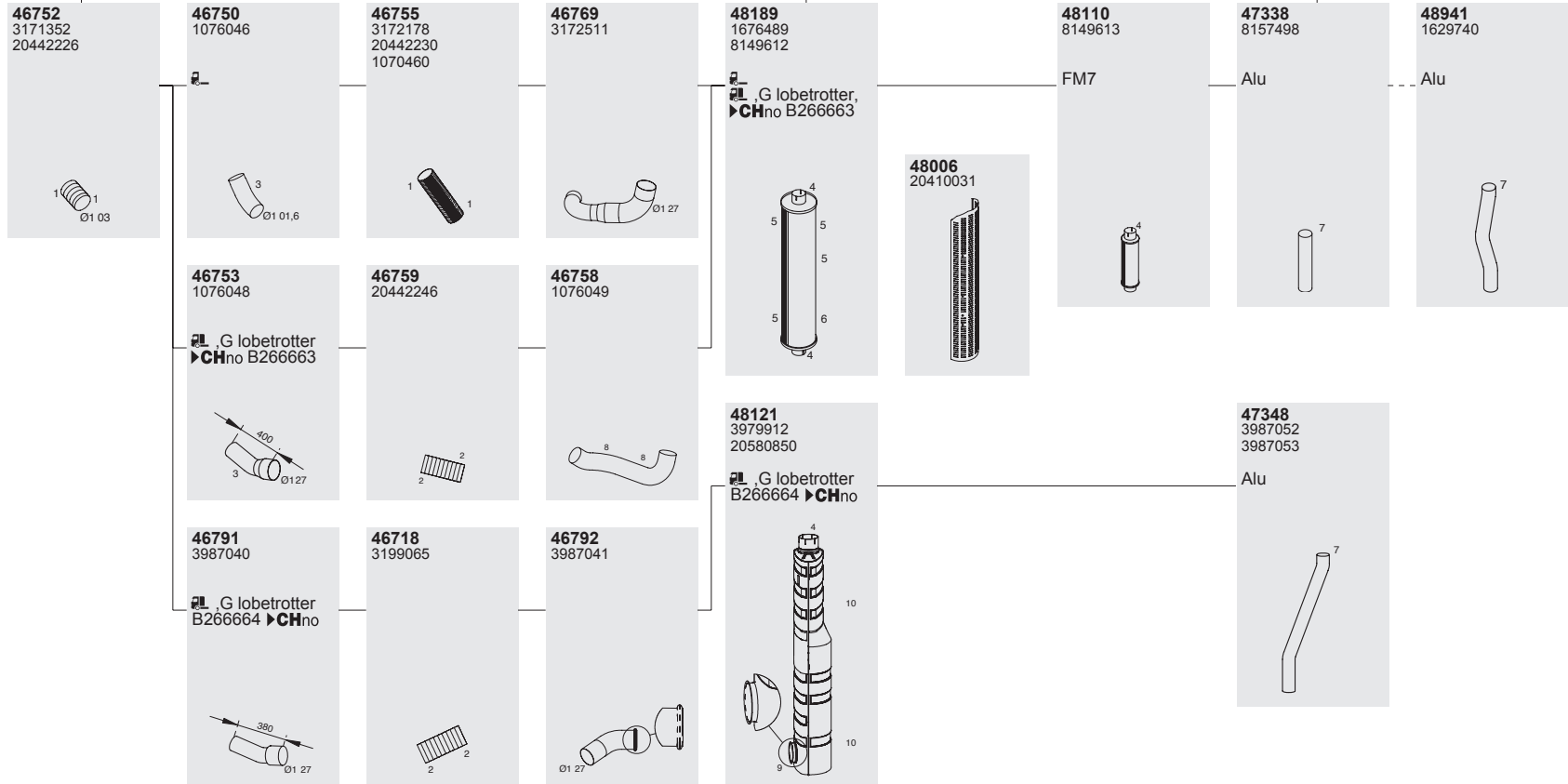

Mounting Parts

- | | | | | | | | | | |
|--|---|-------------------------------|--------------------------------|--------------------------------|--------------------------------|---|-------------------------------|-------------------------------|--------------------------------|
| 1.
00586
8151616
1079026
20871332 | 2.
00584
20455908
8156156 | 3.
00085
1076493 | 4.
99358
20743152 | 5.
48007
20413706 | 6.
48040
20413709 | 7.
04169
8081852
21042291 | 8.
48069
1629067 | 9.
48067
1629499 | 10.
48485
3987072 |
|--|---|-------------------------------|--------------------------------|--------------------------------|--------------------------------|---|-------------------------------|-------------------------------|--------------------------------|

Series FH

Type

Euro II

Globetrotter

FH12
FH16

Front pipeS

47750
1629941

FH12

46718
3199065

47718
1629732

46789
8159960

FH12

46782
8159949

46774
1629942

FH16

47717
1628556

FH16

ilencer

48189
1676489
8149612

48055
1628880

Tail pipe

48110
8149613

80 DB(A)

48941
1629740

47338
8157498

Mounting Parts

1.
48067
1629499

2.
00564
20455908
8156156

3.
48069
1629067

4.
00752
1674248

5.
48040
20413709

6.
48056
1628869

7.
04169
8081852
21042291

Vertical
LHD
Standard

Series FH

Type

Euro II

 
Globetrotter

FH12
FH16

Front pipes

47750
1629941

FH12



46718
3199065



47718
1629732



46789
8159960

FH12



46782
8159949



46774
1629942

FH16



47717
1628556

FH16



ilencer

48189
1676489
8149612



48055
1628880



Tail pipe

48110
8149613

80 DB(A)



48941
1629740



47338
8157498



Mounting Parts

1.
48067
1629499



2.
00564
20455908
8156156



3.
48069
1629067



4.
00752
1674248



5.
48040
20413709



6.
48056
1628869



7.
04169
8081852
21042291



Vertical
LHD
Standard

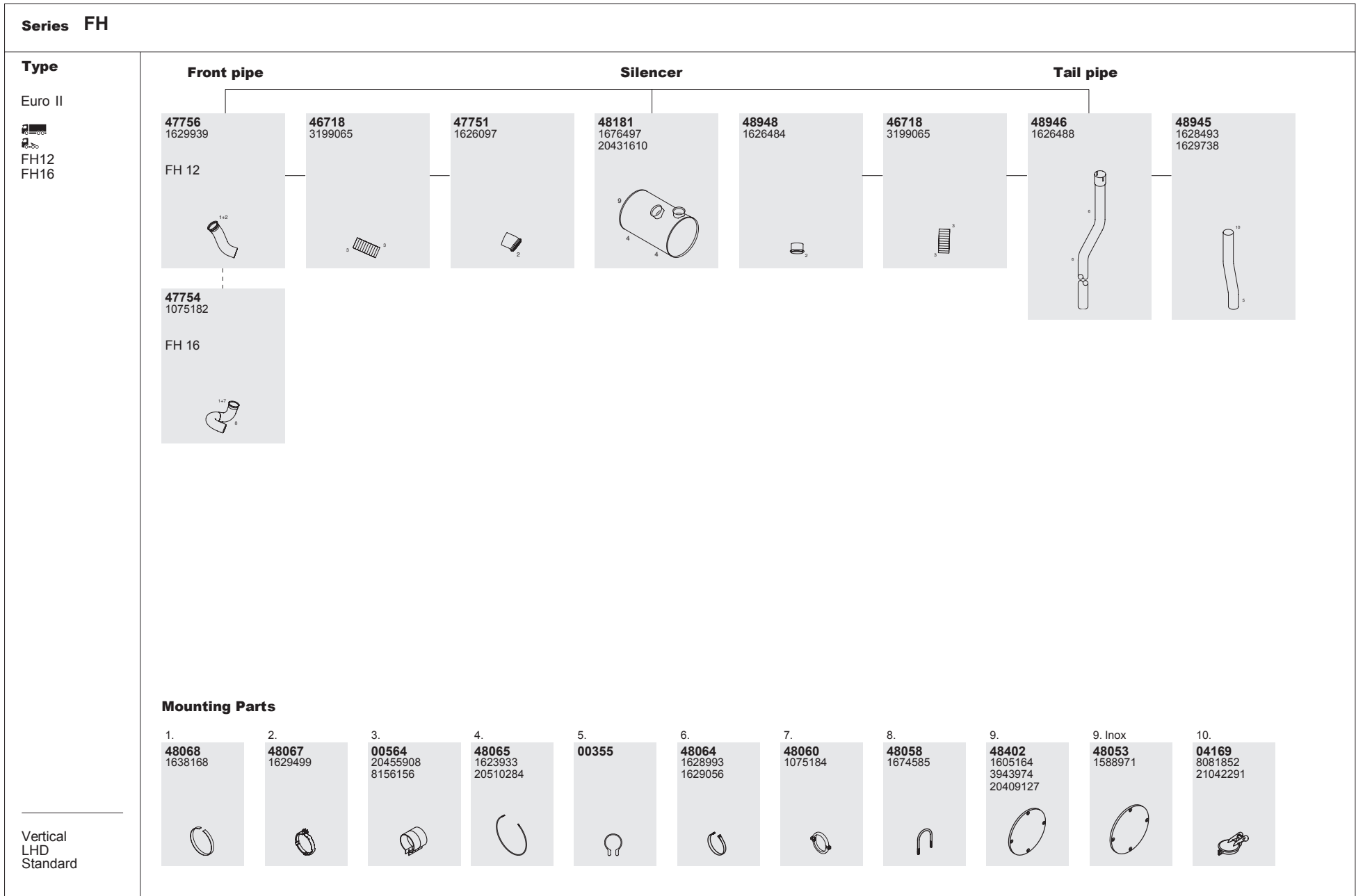

Series FH

Type

Euro III

FAA2 0



D13A
6 cyl.
12.8l tr.
294K W/400H P
324K W/440H P
353K W/480H P
382K W/520H P

D16C
6 cyl.
16.1l tr.
404K W/549H P
449K W/610H P

REAR OUTLET

FAA 20-two
non-driven
front axle

Front pipe

Silencer

Tail pipe

46704
20478685

D16C

46718
3199065

48187
1676496
3979909
3979599

48939
1629054

48934
8147410
8156351
20442244

48998
1628052
20429020
20535530

48126
3944237

47399
3944238

47756
1629939

D13A

47751
1626097

47964
20974489

Mounting Parts

1.
48068
1638168

2.
48067
1629499

3.
00564
20455908
8156156

4.
48065
1623933
20510284

5.
48402
1605164
3943974
20409127

5. Inox
48053
1588971

6.
48069
1629067

7.
48061
1629345
1628246
20743127

Horizontal
LHD/RHD
Standard

Series FH

Type

Euro III
FAA1 0

RAP6440/6540

D12D 6 cyl.
12.1l tr.
250K W/340H P
279K W/379H P
309K W/420H P
338K W/460H P

D16C 6 cyl.
16.1l tr.
404K W/549H P
449K W/610H P

REARO UTLET

Without pusher rear axle
FAA 10-one non-driven front axle
PTOTRA-S Single power take off, transmission
PTOTRA-DD ual power take off, transmission
UPTOTRA Without power take off, transmission
EXHP-SAC Aluminized coated steel exh.pipe
EXHP-SCP Painted carbon steel exhaust pipe

Horizontal LHD/RHD Standard

Front pipe

46709
20506999



46718
3199065



47751
1626097
(EXHP-SAC)



46704
20478685

D16C



46700
20535469
(EXHP-SCP)



Silencer

48187
1676496
3979909
3979599
UEAS

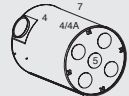

47347
3988977
PTOTRA-D/PTOTRA-S



47969
20745251
UPTOTRA



Tail pipe

48182
1675864

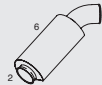

Mounting Parts

1.
48068
1638168



2.
48067
1629499



3.
00564
20455908
8156156



4.
48065
1623933
20510284



4A.
48018
20506176



5.
48402
1605164
3943974
20409127



5. Inox
48053
1588971



6.
48061
1629345
1628246
20743127



7.
31407
20443247



Series FH																																																																																										
Type																																																																																										
Euro III																																																																																										
FH 12																																																																																										
FH 16																																																																																										
	<table border="1"> <thead> <tr> <th>Front pipe</th> <th colspan="3">Silencer</th> <th colspan="4">Tail pipe</th> </tr> </thead> <tbody> <tr> <td> 47759 8184513 8154893 8156660 FH 12 </td> <td> 46718 3199065 </td> <td> 47751 1626097 </td> <td> 48185 8157258 8151798 8149655 Euro II/III </td> <td> 47753 1088969 8157257 </td> <td> 48994 8151798 1078112 20442245 </td> <td> 48990 8154822 </td> <td> 48186 1676499 Euro II/III TUV/KBA 21207 </td> </tr> <tr> <td> 47715 8154894 8154514 FH 16 </td> <td colspan="6"></td> <td> 47974 3183953 Euro III </td> </tr> <tr> <td colspan="2"></td> <td colspan="2"></td> <td colspan="2"></td> <td colspan="2"></td> <td> 47966 20564260 Euro IV/V </td> </tr> <tr> <td colspan="2">Mounting Parts</td> <td colspan="7"></td> </tr> <tr> <td>1.</td> <td>2.</td> <td>3.</td> <td>4.</td> <td>5.</td> <td>6.</td> <td>7.</td> <td>7. Inox</td> <td>8.</td> <td>9.</td> </tr> <tr> <td> 48068 1638168 </td> <td> 48067 1629499 </td> <td> 00564 20455908 8156156 </td> <td> 48063 1088995 </td> <td> 48061 1629345 1628246 20743127 </td> <td> 48069 1629067 </td> <td> 48402 1605164 3943974 20409127 </td> <td> 48053 1588971 </td> <td> 48060 1075184 </td> <td> 48094 3962698 20367256 </td> </tr> <tr> <td colspan="2">Horizontal</td> <td colspan="7"></td> </tr> <tr> <td colspan="2">LHD</td> <td colspan="7"></td> </tr> <tr> <td colspan="2">Standard</td> <td colspan="7"></td> </tr> </tbody> </table>	Front pipe	Silencer			Tail pipe				47759 8184513 8154893 8156660 FH 12 	46718 3199065 	47751 1626097 	48185 8157258 8151798 8149655 Euro II/III 	47753 1088969 8157257 	48994 8151798 1078112 20442245 	48990 8154822 	48186 1676499 Euro II/III TUV/KBA 21207 	47715 8154894 8154514 FH 16 							47974 3183953 Euro III 									47966 20564260 Euro IV/V 	Mounting Parts									1.	2.	3.	4.	5.	6.	7.	7. Inox	8.	9.	48068 1638168 	48067 1629499 	00564 20455908 8156156 	48063 1088995 	48061 1629345 1628246 20743127 	48069 1629067 	48402 1605164 3943974 20409127 	48053 1588971 	48060 1075184 	48094 3962698 20367256 	Horizontal									LHD									Standard								
Front pipe	Silencer			Tail pipe																																																																																						
47759 8184513 8154893 8156660 FH 12 	46718 3199065 	47751 1626097 	48185 8157258 8151798 8149655 Euro II/III 	47753 1088969 8157257 	48994 8151798 1078112 20442245 	48990 8154822 	48186 1676499 Euro II/III TUV/KBA 21207 																																																																																			
47715 8154894 8154514 FH 16 							47974 3183953 Euro III 																																																																																			
								47966 20564260 Euro IV/V 																																																																																		
Mounting Parts																																																																																										
1.	2.	3.	4.	5.	6.	7.	7. Inox	8.	9.																																																																																	
48068 1638168 	48067 1629499 	00564 20455908 8156156 	48063 1088995 	48061 1629345 1628246 20743127 	48069 1629067 	48402 1605164 3943974 20409127 	48053 1588971 	48060 1075184 	48094 3962698 20367256 																																																																																	
Horizontal																																																																																										
LHD																																																																																										
Standard																																																																																										

Series FH

Type

Euro III

-  
-  
-  
-  
- Rear outlet

FH12
FH16

Front pipe

47756
1629939



46718
3199065



47751
1626097



Silencer

48187
1676496
3979909
3979599
TÜV/ KBA 21206



Tail pipe

47337
3962786

 6a irbellows



48182
1675864

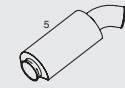

47754
1075182

FH 16



47336
8159458

 Air suspension rear
 Leaf suspension rear
Rear axle pos. 6540 mm



48995
1625965
8190133



Mounting Parts

1.
48068
1638168



2.
48067
1629499



3.
00564
20455908
8156156



4.
48065
1623933
20510284



5.
48062
1629345



6.
48060
1075184



7.
48058
1674585



8.
48402
1605164
3943974
20409127



8. Inox
48053
1588971



Horizontal
LHD
Standard

Series FH

Type

Euro II/III



FH 12
D12A
→ 2002

D12D
2002 →

FH 16

Front pipe

47756
1629939

FH 12

46718
3199065

47751
1626097

Silencer

48187
1676496
3979909
3979599
TÜV/KBA 21206

48933
1628883

48934
8147410
8156351
20442244

Tail pipe

48998
1628052
20429020
20535530
Clutch power take off

48186
1676499

Euro II/III
TÜV/ KBA 21207

47754
1075182

FH 16

48939
1629054

Low chassis

48997
8147305

Low chassis

47974
3183953

Euro III

Mounting Parts

1.
48068
1638168

2.
48067
1629499

3.
00564
20455908
8156156

4.
48065
1623933
20510284

5.
48061
1629345
1628246
20743127

6.
48069
1629067

7.
48058
1674585

8.
48060
1075184

9.
48402
1605164
3943974
20409127

9. Inox
48053
1588971

10.
48044
8156575

48996
1629057

Clutch independent power take off

47966
20564260

Euro IV/V

46715
1629055

Excl.C lutch power take off
Incl.A uustria

Horizontal
LHD
Standard

Series FH

Type

Euro III

FAA2 0



☞ D12D 6 cyl.
12.1l tr.
250K W/340H P
279K W/379H P
309K W/420H P
338K W/460H P

☞ D13A 6 cyl.
12.8l tr.
294K W/400H P
324K W/440H P
353K W/480H P
382K W/520H P

☞ D16C 6 cyl.
16.1l tr.
404K W/549H P
449K W/610H P

FAA2 0T wo
non-driven front
axle

PTOFLY With
power take off,
flywheel admin.

UPTOFLY
Without power
take off on
flywheel housing

UAD-CHASX
Without
aerodyn.device

AD-CHASX
Aerodyn.device,
extended chassis
fairing

Horizontal
LHD
Standard

Front pipe

46711
20409103

☞ D12D

46704
20478685

☞ D16C

47756
1629939

☞ D13A

Silencer

46718
3199065

47751
1626097

48187
1676496
3979909
3979599

48939
1629054

48934
8147410
8156351
20442244

48998
1628052
20429020
20535530
UPTOFLY
EXHP-SAC

47974
3183953

UAD-CHASX

47970
3943722

PTOFLY

47966
20564260

AD-CHASX

Mounting Parts

1.
48068
1638168

2.
48067
1629499

3.
00564
20455908
8156156

4.
48065
1623933
20510284

5.
48402
1605164
3943974
20409127

6.
48069
1629067

7.
48061
1629345
1628246
20743127

Series FH

Type

Euro III
09/2000 →

18 ton.
26 ton.



D13A
6 cyl.
12,8l tr.
294K W/400H P
324K W/440H P
353K W/480H P
382K W/520H P

Front pipe

Silencer

Tail pipe

<p>46711 20409103</p> <p>1, G lobetrotter, GlobetrotterX L</p>	<p>47755 8156350 1078110 3199065 81133</p>	<p>46715 20409099</p>	<p>48121 3979912 20580850</p>	<p>47348 3987052 3987053</p>
---	---	----------------------------------	--	---

<p>46717 20367760</p>	<p>47755 8156350 1078110 3199065</p>	<p>46716 20367761</p>	<p>48122 3183697 20582423</p>	<p>47338 8157498</p>
----------------------------------	---	----------------------------------	--	---------------------------------

Mounting Parts

<p>1. 48068 1638168</p>	<p>2. 48067 1629499</p>	<p>3. 00564 20455908 8156156</p>	<p>4. 48485 3987072</p>	<p>5. 00358 20743152</p>	<p>6. 04169 8081852 21042291</p>
--	--	---	--	---	---

Vertical
LHD/RHD
Standard

Series FH

Type

Euro II/III
08/93 →
18,21,26,27 ton.
28,29 ton.
32,35,37 ton.

FH12

∅ D12D 6 cyl.
12,1l tr.
250K W/340H P
279K W/379H P
309K W/420H P
338K W/460H P
368K W/500H P

- ④X②⑥X②
- ⑥X④⑧X④
- ④X②⑥X④
- ⑥X②/②
- ⑥X②/④
- ⑥X④

FH16

∅ D16C 6 cyl.
16,1l tr.
404K W/549H P
449K W/610H P

∅ D16E 6 cyl.
16,1l tr.
426K W/580H P
485K W/660H P

- ④X②
- ⑥X②⑥X④
- ⑧X②⑧X④
- ④X②⑥X②/②
- ⑥X②/④⑥X④

Vertical
LHD/RHD
Standard

Front pipe

46795
20409097

FH12

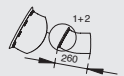

46711
20409103

FH12

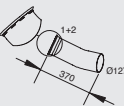

46793
20478687

FH16

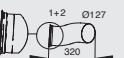

46717
20367760

FH12

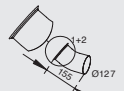

47755
8156350
1078110
3199065



46715
20409099



47755
8156350
1078110
3199065



46716
20367761



Silencer

48121
3979912
20580850

FH16

FH12
G lobetrotter,
GlobetrotterX L

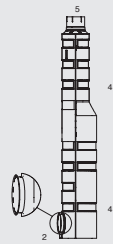

48122
3183697
20582423

FH 12

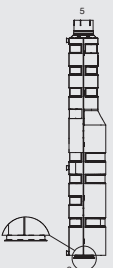

Tail pipe

47348
3987052
3987053



47338
8157498



Mounting Parts

1.
48068
1638168



2.
48067
1629499



3.
00564
20455908
8156156



4.
48485
3987072



5.
00358
20743152



6.
04169
8081852
21042291



**SOYLU EGZOZ YEDEK PARÇA
SAN. VE TİC. LTD. ŞTİ.**

İkitelli OSB. Dolapdere Sanayi Sitesi 5. Ada No: 8-10
İkitelli 34306 Başakşehir İstanbul Türkiye
T +90 212 671 12 27 - 28 - 77
F +90 212 671 12 29
info@soylu.com www.soylu.com

HER KİLOMETREDE YENİ / NEWER IN EVERY MILE

